

1st International Conference on ESAR „Expert Symposium on Accident Research“

**Berichte der
Bundesanstalt für Straßenwesen**

Fahrzeugtechnik Heft F 55

bast

1st International Conference on ESAR „Expert Symposium on Accident Research“

**Reports on the ESAR-Conference
on 3rd/4th September 2004
at Hannover Medical School**

organized by

Accident Research Unit at Hannover Medical School (MHH)
Federal Highway Research Institute, Bergisch Gladbach (BASt)
Research Association of German Car Manufacturers,
Frankfurt/M., (FAT)
University of Technology, Dresden

**Berichte der
Bundesanstalt für Straßenwesen**

Fahrzeugtechnik Heft F 55

bast

Die Bundesanstalt für Straßenwesen veröffentlicht ihre Arbeits- und Forschungsergebnisse in der Schriftenreihe **Berichte der Bundesanstalt für Straßenwesen**. Die Reihe besteht aus folgenden Unterreihen:

A - Allgemeines
B - Brücken- und Ingenieurbau
F - Fahrzeugtechnik
M- Mensch und Sicherheit
S - Straßenbau
V - Verkehrstechnik

Es wird darauf hingewiesen, dass die unter dem Namen der Verfasser veröffentlichten Berichte nicht in jedem Fall die Ansicht des Herausgebers wiedergeben.

Nachdruck und photomechanische Wiedergabe, auch auszugsweise, nur mit Genehmigung der Bundesanstalt für Straßenwesen, Referat Öffentlichkeitsarbeit.

Die Hefte der Schriftenreihe **Berichte der Bundesanstalt für Straßenwesen** können direkt beim Wirtschaftsverlag NW, Verlag für neue Wissenschaft GmbH, Bgm.-Smidt-Str. 74-76, D-27568 Bremerhaven, Telefon (04 71) 9 45 44 - 0, bezogen werden.

Über die Forschungsergebnisse und ihre Veröffentlichungen wird in Kurzform im Informationsdienst **BAST-Info** berichtet. Dieser Dienst wird kostenlos abgegeben; Interessenten wenden sich bitte an die Bundesanstalt für Straßenwesen, Referat Öffentlichkeitsarbeit.

Impressum

Herausgeber

Bundesanstalt für Straßenwesen
Brüderstraße 53, D-51427 Bergisch Gladbach
Telefon: (0 22 04) 43 - 0
Telefax: (0 22 04) 43 - 674

Redaktion

Referat Öffentlichkeitsarbeit

Druck und Verlag

Wirtschaftsverlag NW
Verlag für neue Wissenschaft GmbH
Postfach 10 11 10, D-27511 Bremerhaven
Telefon: (04 71) 9 45 44 - 0
Telefax: (04 71) 9 45 44 77
Email: vertrieb@nw-verlag.de
Internet: www.nw-verlag.de

ISSN 0943-9307
ISBN 3-86509-263-2

Bergisch Gladbach, April 2005

Kurzfassung – Abstract

1. Internationale Konferenz ESAR, “Expertensymposium Accident Research”

In den zurückliegenden Jahren hat sich die aktive und passive Sicherheit der Fahrzeuge im Straßenverkehr deutlich verändert. Der Straßenverkehr ist heute viel sicherer als früher. Das Auto von heute ist mit vielen Sicherheitselementen im Fahrzeuginnen- und Fahrzeugaußen ausgestattet. So hat sich trotz eines stetigen Anstieges der Zahl aller Verkehrsteilnehmer die Zahl der Verkehrstoten in den meisten europäischen Ländern ständig reduziert. Es gilt jedoch, weitere Maßnahmen zu entwickeln, um die immer noch sehr hohe Zahl der Verkehrsunfallopfer im Straßenverkehr zu senken und dabei insbesondere die Zahl der Verkehrstoten um nochmals 50 % zu senken, wie dies die Europäische Kommission bis zum Jahr 2010 vorsieht.

Um geeignete Maßnahmen und Möglichkeiten der Verletzungsprophylaxe zu konzipieren, gilt es, das Unfallgeschehen durch Analyse von Unfalldaten zu verifizieren und dabei detaillierte Ergebnisse für ganz Europa darzustellen. So genannte „In-Depth Data“ werden vor Ort von einem wissenschaftlichen Team erhoben, sie liefern die Möglichkeit, Verletzungen und Fahrzeugdeformationen sowie die Unfallkinematik im Detail zu erfassen. Derartige Datensammlungen haben eine große historische Entwicklung vollzogen. Erste Erhebungen begannen in den 60er Jahren durch die Automobilindustrie, in den 70er Jahren begannen einige Universitäten in England, Schweden, Frankreich und Deutschland Unfälle zu wissenschaftlichen Zwecken vor Ort zu erheben. Heutzutage gibt es ein über Europa und rund um die Welt verteiltes Netzwerk von Erhebungsteams.

Eines der ältesten und weltweit bekanntesten Teams ist an der Medizinischen Hochschule Hannover positioniert. Es wurde im Jahr 1973 im öffentlichen Auftrag durch die Bundesanstalt für Straßenwesen gegründet und war das weltweit einzige Team, das mit speziellen Blaulichtfahrzeugen ausgerüstet die Unfallstelle unmittelbar nach dem Ereignis anfuhr und kontinuierlich über mehr als 30 Jahre hinweg über 20.000 Unfälle dokumentierte. Seit 1999 werden diese Erhebungen in Kooperation mit der Deutschen Automobilindustrie

FAT durchgeführt, die an den detaillierten Informationen aus dem Unfallfeld Interesse für den Nutzen zur Implementierung von Fahrzeugsicherheit haben. Auf der Basis dieser neuen Datenerhebung GIDAS (German In-Depth Accident Study) werden Verkehrsunfälle von der Technischen Universität Dresden und der Medizinischen Hochschule Hannover gemeinsam analysiert und in einer Datenbank bereitgestellt. Damit ist eine Möglichkeit geschaffen, fortlaufend Verkehrsunfälle in der Tiefe zu analysieren.

Das Ziel der Konferenz ist es, eine internationale Diskussionsebene für Wissenschaftler zu bilden, die sich mit solchen In-Depth-Erhebungen und der Analyse von Detailinformationen aus dem Verkehrsunfallgeschehen befassen. Ein spezielles Ziel der Konferenz ist es dabei auch, eine Harmonisierung der unterschiedlichen europa- und weltweit existierenden Erhebungsmethoden und Begriffsbestimmungen bei der Datenerhebung zu schaffen und die unterschiedlichen Ergebnisse nutzbringend zusammenzuführen. Bislang gibt es weltweit keine derart spezielle Konferenz, die sich ausschließlich mit der Unfalldatenanalyse solcher In-Depth-Erhebungen befasst, ESAR (Expert Symposium on Accident Research) soll ein Weg in diese Richtung darstellen. Die 1. Internationale Konferenz wurde von der Verkehrsunfallforschung an der Medizinischen Hochschule Hannover gemeinsam mit der Bundesanstalt für Straßenwesen und der Forschungsvereinigung Automobiltechnik (FAT) organisiert und durchgeführt. Die verschiedenen Präsentationen beinhalten wissenschaftliche Erkenntnisse zu Gesetzgebung, Verbraucherschutz, Erhebungs- und Analysemethoden. Spezielle Themen sind dem äußeren Verkehrsteilnehmer, der Verletzungsprophylaxe und den Verletzungsmechanismen sowie den Unfallursachen gewidmet.

Ich begrüße alle Teilnehmer und Teilnehmerinnen sowie alle Kollegen und Kolleginnen zu dieser ersten internationalen Konferenz und wünsche einen erfolgreichen Austausch an Informationen.

1st International Conference on ESAR “Expert Symposium on Accident Research”

In recent years considerable progress in active and passive safety of road vehicles has been made. The road traffic of today is much safer than in the past. A current vehicle has a lot more safety elements resulting in an improved inner and outer technique. In most European countries the number of fatalities is decreasing despite growing traffic and road usage. Nevertheless, the number of casualties in road traffic accidents is high enough, thus more progress is needed if the number of fatalities is to be reduced by 50%, as postulated by the European Commission for the year 2010.

In order to develop countermeasures and further possibilities for injury prevention, it is increasingly important to have accident data available, supplying results quickly and giving the best overview across Europe. In-Depth-Data Sampling Procedures have a huge historical development, starting in the 60ies by the car manufactures, continued during the 70ies mostly by some universities mainly in England, Sweden, France and Germany, today a net of in-depth-investigation teams are working across Europe and around the world.

One of the oldest teams is located at the Hannover Medical School, founded in 1973 by the German Government on behalf of the Federal Highway Research Institute (BAST). It was the only team worldwide that was equipped with blue light emergency cars, working on scene in time so directly after the event and working continuously during the years, collecting 20 thousand accidents within 30 years period. Since 1999 the order is carried out in cooperation with the German car industry, which is interested and has benefit on the data too. On the basis of the new data collection, so called GIDAS (German In-Depth Accident Study), that has been run at the Technical University Dresden and the Medical University Hannover), a special tool for In-Depth-Accident Analysis was founded.

It is the task of this conference to build a platform for such research based on In-Depth-Investigation. The conference is specially aimed at the area of accident data analysis in order to contribute to the harmonization of different investigation methods and accumulation of different results that does

exist for different countries worldwide. Up to now no special conference did exist to deal with accident data only following in the discussion for an improvement in traffic and vehicle safety. ESAR – Expert Symposium on Accident Research – should be a step forward. This first international conference is being organized by the Accident Research Unit at the Medical University Hannover jointly with the German Federal Highway Research Institute Bast and the Research Association of German Car Manufacturers FAT. The conference should be a platform for an interdisciplinary exchange of information based on the different presentations from participants around the world.

I personally welcome all delegates and colleagues to this event and I am looking forward to have a fruitful and successful exchange of information.

Contents

Welcome Addresses for the 1st International Conference on ESAR „Expert Symposium on Accident Research“ by Representatives of Government and Industry

J. Werren	8
E. Brühning	10
T. von Jahn	12
C. Krettek	14
Keynote Lecture: The Evolution of Accident Research	
M. Mackay	15

Session: Regulation, Consumer Aspects and Methodology – Part I

Possibilities of In-Depth Investigation Methodology for Injury and Accident Prevention on the Example of Car Accidents with Rollover – An In-Depth Analysis by GIDAS	
D. Otte	24
Expansion of GIDAS Sample Data to the Regional Level: Statistical Methodology and Practical Experiences	
H. Hautzinger, M. Pfeiffer, J. Schmidt	38
A Common Methodology for Truck Accident In-Depth Study	
M. C. Simon, T. Hermitte, P. White	44
A New Method for the Evaluation of the Quality of Accident Reconstructions	
F. Alonzo, M. Nguyen, J. P. Verriest	57

Session: Regulation, Consumer Aspects and Methodology – Part II

Target Population of Improved Compatibility for Germany	
C. Pastor	72
Rollover Scenarios in Europe	
G. Gugler, H. Steffan, G. Lutter, S. Fleischer	77

In-Depth Accident Investigation of Rollovers as a Basis for the Development of New Testing Procedures	
J. M. Barrios, S. J. Busby, J. Huguet, V. Salvachúa, G. Tejera	85

Split-Register Study: A new Method for Estimating the Impact of Rare Exposure on Population Accident Risk Based on Accident Register Data	
U. Grömping, S. Menzler, U. Weimann	95

The Patterns of Traffic Accidents in Thailand	
R. Choiejit, R. Teungfung	102

Keynote Lecture: Importance of In-Depth Investigation for Road Safety	
R. Nagel	109

Session: Vulnerable Road Users

Detailed Investigations and Reconstructions of Real Accidents Involving Vulnerable Road Users	
T. Serre, C. Perrin, M. Bohn, M. Llari, C. Cavallero	114

The Dynamic Responses and Head Injury Correlations of Child Pedestrians Involved in Vehicle Accidents	
J. K. Yang, D. Otte, J. F. Yao	125

„Whiplash“ Testing and Assessment – Summary of Current Activities in Europe	
B. Lorenz, R. Sferco	136

Pedestrian Road Accidents in Japan	
K. Okamura, S. Ito	147

Accidents Involving Motorcycles and Pedestrians in Portugal	
J. P. Dias	158

Accident and Injury Causation of Motorcycle Accidents	
D. Margaritis, Y. W. R. de Vries, H. G. Mooi	166

Poster Session

Accident Analysis and Prevention. The E-Safety Accident Causation Analysis Group Experience M. Hollingworth, Y. Page, M. Stanzel	178
Pedestrian Safety: International Collaborative Research Based on Real World Crash Data B. Fildes, A. Linder, A. Clark, D. Otte, H. C. Gabler, J. K. Yang, R. Frederikkson, Y. Fuyita, D. Cessari, K. Yang, L. Sparke, S. Smith	180
Co ₂ and O ₂ Concentrations in Integral Motorcycle Helmets: Cause for Alarm? P. A. Brühwiler, R. Stämpfli, R. Huber, M. Camenzind	184
Is the Kneebag Save in Out of Position Situations? G. Schroeder, U. Bosch	189
Severe Seat-Belt Syndrome in Children: A Case Report of Two Children S. Hauck, R. Beisse, V. Bühren	192
A Finite Element Study on the Behavior of Human Pelvis under Impact through Car Door S. Majumder, A. Roychowdhury, S. Pal	196
A Proposal for a Coordinated In-Depth Crash Investigation Programme in Spain J. Monclus	204
Establishing the European Road Accident Observatory – the SafetNet Integrated Project P. Thomas, , A. Morris, G. Yannis, P. Lejeune, P. Wesemann, G. Vallet, W. Vanlaar	207

Session: Accident Prevention and Causation – Part I

Computerized Case by Case Analysis for Evaluation of Primary Safety Systems Regarding Accident Prevention L. Hannawald	210
Crash Investigation for Active Safety – Meeting New Demands on Investigation Methodology J. Sandin, M. Ljung	216

Old Drivers and Possibilities for Injury Avoidance B. Fildes, J. Charlton	225
--	-----

Session: Accident Prevention and Causation – Part II

Assessment of Accident Causation from the Viewpoint of In-Depth Investigation on Scene – Traffic Psychological Methodology on Examples of In-Depth Cases by GIDAS B. Pund, D. Otte	236
Interaction of Road Environment, Vehicle and Human Factors in the Causation of Pedestrian Accidents J. Lenard, J. Hill	250
Is ESP Effective on French Roads? Y. Page, S. Cuny	256

Session: Injury Prevention and Mechanisms

Foot Injuries in Car Occupants R. Schubert, T. Illert, H. Zwipp	270
In-Depth Study of Front Seat Occupants in Accidents in Relation to Seat-Belt Use of Rear Seat Passengers M. Shimamura, H. Ohashi, M. Yamazaki, K. Okamura	274
Accident and Whiplash Injuries Prevention in Nigeria S. I. Oni	282

Welcome Addresses
for the 1st International Conference on ESAR
“Expert Symposium on Accident Research”
by Representatives of Government and Industry

J. Werren

E. Brühning

T. von Jan

C. Krettek

J. Werren
Secretary of State Ministry for Economics, Labour
and Transport of Niedersachsen, Hannover,
Germany

Salutation,

First of all I would like to convey to you the sincere greetings of the State Minister of Economics and Transport, Mr Walter HIRCHE. Both he and I myself hope that this international conference "Expert Symposium on Accident Research" will give rise to interesting and fruitful discussions, and will come up with many ideas and results that will be reflected in measures to reduce the number of accidents. Enhanced road safety is of course also one of the central concerns of the Lower Saxony State Government.

Accident statistics may be helpful in allowing a balance to be drawn of the work that is put into promoting road safety; but they can never be a matter for satisfaction, since quite apart from the economic costs involved, behind the sober statistics lie the pain and suffering of so many people, especially of the injured, and of the families and friends of accident victims.

As the enhancement of road safety is a matter that concerns citizens of all social backgrounds and age groups, it is a task for the whole of society; and to ask the state to shoulder the burden alone would be to ask too much of it. Although the number of motor vehicles in Germany has trebled between 1970 and today, the number of road deaths has been cut to about one-third of the level then. This success has only been possible thanks to the unceasing joint efforts and constructive cooperation of dedicated people in all fields relevant to safety: those involved in traffic education and in the further development of traffic law, the police who monitor traffic and prosecute offenders, those who run educational campaigns or work in the emergency services or in the fields of traumatology and accident research, or who apply the findings of such research in the vast field of automotive engineering.

The ambitious aim of some Scandinavian countries to reduce the number of accident deaths to zero, known as "Vision ZERO", may sound utopian, but it does compel us to turn our attention away from partial aspects and instead to consider road transport as an overall system. In my view, this is

the only way in which the European Union's target of reducing the number of fatal accidents to 50% of the 2001 figure by the year 2010 can be anything like achieved. Keeping the entire system in view makes it easier to appreciate and understand the extraordinarily complex interrelationships and interactions between people, vehicles, roads, the environment etc. And this in its turn helps us to resist superficial observations and attempts at explanation – which in the field of road safety, concerned as it is with protecting fundamental values such as life and health, it is vitally important to do. Because only if we can find out as precisely as possible how and why particular phenomena which lead amongst other things to accidents come about, do we really have any chance of improving the situation.

Superficial schemes of explanation for the causes of accidents, illusionary ideas as to how accidents can be avoided and suggestions arising out of vested interests are plentiful. On the basis of their own driving experience or as a result of having been personally affected, many people seem to be convinced that they have completely grasped the problems and ramifications and know the right answers. Accident research makes an important contribution towards ensuring that the results obtained stand up to scientific and academic scrutiny, and can be applied in their turn in active or passive vehicle safety, in vehicle or highway design. I hope that as the representative of a Lower Saxony Government ministry, I may be allowed at this point to emphasise particularly the role played by Hannover Medical University, as against that of the Technical University Dresden, and especially the role played by in Hannover by Professor Dietmar OTTE. Professor OTTE has been working in this field with enormous dedication for over 30 years, thus embodying in his own person the "sustainability principle" in this area. Apart from that, his academic work, which now encompasses over 300 publications and 13 books, has been published all over the world.

Ladies and Gentlemen,

Road traffic is a system of social interaction. Every day, in Germany, in Europe and throughout the world, millions of people with differing attitudes and in a variety of different states of mind encounter each other, and somehow – whether deliberately or just by chance – succeed in

adapting their behaviour to each others' and coordinating it. The fact that this "somehow" does not end in chaos is due amongst other things to social controls and trust. If, for example, you are a driver on a motorway, you can only achieve a modicum of relaxation because you trust others to behave properly, while those others, of course, expect the same of you.

However, it is not ultimately what is laid down in laws and regulations that is the decisive factor in this, since even strict observation of the rules does not by any means always guarantee road safety. The rules may provide an essential framework of guidance, but they cannot determine in detail how best to cope with any particular situation. A comparison of the accident statistics for experienced and inexperienced drivers shows that especially in critical situations, it is years of driving experience that give drivers the best chance of managing to avoid an accident after all. And there is no other way of achieving that than by simply accumulating driving experience over the years.

At the heart of the transport system is the human being: the road user, passenger or pedestrian. The transport system in its turn forms a part of our social system. The social climate, the prevailing values, attitudes, basic assumptions and lifestyles have an impact on road traffic as on everything else. And if we seek to view things realistically, we cannot close our eyes to the fact that there are numerous tensions, conflicts and contradictions: fast cars and wide, straight roads on the one hand, and the requirement to observe speed restrictions on the other; car advertisements that evoke images of freedom and the fun of driving versus the requirement to exercise caution, keep calm and show consideration to other road users; the positive value that society places on a willingness to take risks and an ability to get one's own way, set against the demand for restraint and partnership on the roads. These contradictions seem to be largely insoluble, but in attempting to reconcile as far as possible mobility and road safety for the common good, it is ultimately a matter of ensuring, to adapt a quotation from Goethe's "Faust", that "our strivings never cease". Thank you very much.

Dr.-Ing. E. Brühning on behalf of
President and Professor Dr.-Ing. J. Kunz
Federal Highway Research Institute,
Bergisch Gladbach, Germany

Good morning,

Ladies and Gentlemen,

First, I would like to convey the greetings of the President of the BAST, Dr. KUNZ, who, to his great regret, cannot be with us here and who has asked me to stand in for him.

I do not want to anticipate the Keynote Lecture which the Secretary of State Mr. NAGEL will give this afternoon. But it is certainly proper at the start of this 1st International Conference on ESAR, to point out that we have achieved great success in road safety here in Germany in the past 30 years. With a multiple increase in mileage and the number of vehicles, the number of traffic fatalities has been reduced in this period from more than 20 000 to 6 613 in the year 2003. This is the lowest ever recorded. In the first half of 2004 there has been a further reduction of 14%.

There are many reasons for this success. It has not occurred by itself. There have been clear safety-relevant changes in all areas of road safety: in road network development and the design of the road environment, in traffic engineering and control and the construction of vehicles, in driver training and safety education, in rescue service and traffic law.

For more than 30 years the traffic safety research of the Federal Highway Research Institute (the BAST) has contributed to these developments. Here, right from the start, emphasis was placed on the proper provision of accident data which also included the interdisciplinary research into causes, conditions and consequences of accidents by medical experts, vehicle technicians and traffic experts. After some years these efforts were concentrated here in Hannover and thus, for almost 30 years, the in-depth accident investigation on behalf of the BAST was conducted here in Hannover. Over the years, this resulted in a remarkable improvement in the quality of the data and the method of its collection. Also the quantity of the annually collected accidents was increased. Data from the "Accident Research Unit Hannover" became an indispensable basis for questions in biomechanics and passive vehicle safety. They are

required for early detection of the changes in the structure of the course of accidents. The data also served as the base for investigations into active vehicle safety and for questions on the design of roads and road equipment.

In-depth accident investigation is expensive! Money-saving proposals, that after so many years one really should know everything and the money for this expensive collection of data can be better used elsewhere, could however be easily rejected by BAST.

On the contrary: because of the increasing need for data, the GIDAS project (German In-Depth Accident Study) was started in 1999. In this joint project by the Federal Highway Research Institute (BAST) and the German Association for Research on Automobile Technique (FAT), research on traffic accidents is now carried out at two places, Hannover and Dresden. The structure of this joint project is based on the experience of in-depth accident investigation here at the Medical University of Hannover. In addition to the already established team there was formed 5 years ago a further team at the Technical University in Dresden. The statistical significance of the collected data has been greatly increased by this intensifying of the national accident research. The reason for this is the greater number of individual accidents that are investigated and the different regional structure of the collection regions.

For the automobile industry and the Federal Highway Research Institute, the GIDAS database provides the possibility of undertaking comparisons between actual accident events and crash experiments. Vehicle structures that can cause injuries can be identified. In addition, the data is used for developing test programmes for supporting and validating computer simulations, for recognizing and estimating potential regions of future safety developments and for evaluating the vehicle-safety-performance in actual accident events.

Ladies and Gentlemen,

The great safety achievements of the past that I mentioned at the beginning must be continued. But they do not happen by "themselves". The German Federal Ministry for Transport, Construction and Housing, in its programme for more safety in road traffic has highlighted means and ways of

protecting human lives. Substantial improvement in safety with increasing mobility is also the aim of the 3rd traffic safety programme of the EU and its white book "Time for decision": 50% less traffic deaths in the 15 EU countries by the year 2010 is an ambitious goal. The result of this is an international need for reliable and detailed accident data.

With this background the international orientation of this conference is especially important and for this reason I would very much like to welcome the guests from other European countries and from Africa, America, Asia and Australia.

I wish all the speakers and participants at this "1st International Conference on ESAR" not only new ideas and practical information for more traffic safety, but also interesting discussions and fruitful contacts in the breaks and at the conference dinner tonight.

My special thanks go to Professor OTTE and his staff who initiated and organized this conference.

I wish all of us an informative and interesting meeting with constructive discussion and future-oriented solutions.



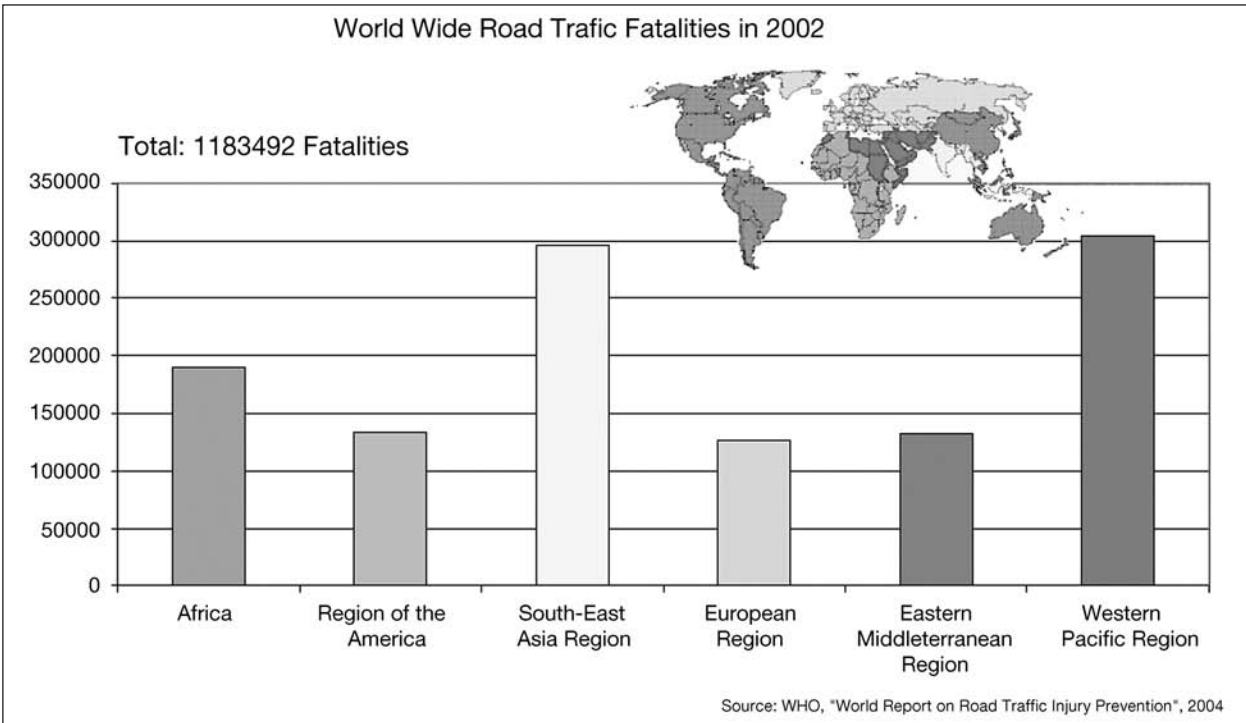

Finally, I wish the 1st ESAR conference much success.

T. von Jan
 Director of Department Research
 Volkswagen AG
 Konzernforschung
 Wolfsburg, Germany

Accident Data for Enhanced Safety

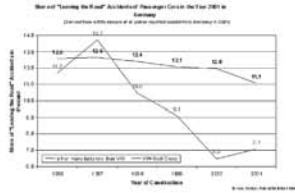

WHO Figures of Road Traffic Fatalities in 2002

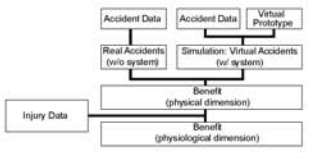
Single Case Investigation	Statistical Data Analysis
 <ul style="list-style-type: none"> Scene documentation, accident reconstruction and causation analysis by engineers and psychologists 	<ul style="list-style-type: none"> Analysis of different national and international accident data sources 
 <ul style="list-style-type: none"> Vehicle analysis and damage documentation by engineers 	<ul style="list-style-type: none"> Development of methodology for benefit assessments 
 <ul style="list-style-type: none"> Injury and injury causation analysis by medical doctors and engineers 	<ul style="list-style-type: none"> Prediction of safety measures benefit 
<h3>Comprehensive Accident Research</h3>	

Steering Committee	BAST Research Unit of the Federal Department of Transportation	FAT Research Unit of the Association of German Automotive Industry (VDA) Ford, Volkswagen, DaimlerChrysler, Porsche, GM, BMW, TRW, Autoliv, JCI
	University of Hannover and University of Dresden	
Research Contractors	Common investigation standard and method 2 000 cases / year, (1 000 each location) staff of 100 people interdisciplinary teams: medical doctors, engineers	

Unique Organisation of the GIDAS project

	Skidding		Total	Skidding-Risk
	yes	no		
With ESP	11	163	174	6,3%
Without ESP	149	292	441	33,8%
Total	160	455	615	26,0%
Efficiency				81,3%

ESP reduces the Risk of Skidding by approx. 80 %
Based on 600 cases investigated by VW group accident research

ESP Reduces the Risk of Skidding

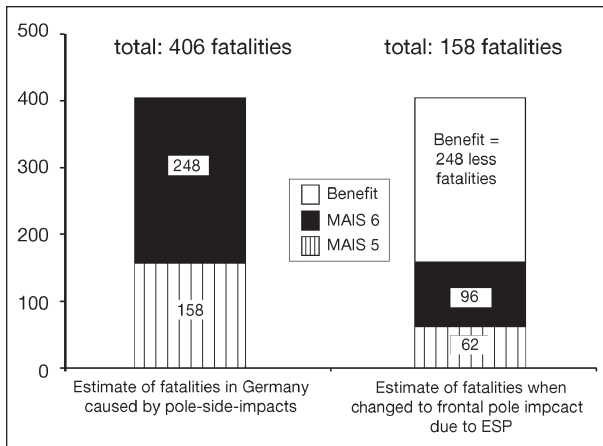

1998 Predicted ESP Benefit at Pole-to-Side-Collisions

Accident Data has to be:

- statistically representative
- independent,
- comprehensive (investigating accident scene, injuries, damages and course of events).

GIDAS fulfils these requirements.

Substantial Requirements

Professor Dr. Christian Krettek, FRACS
Director Trauma Department
Hannover Medical School, Germany

Dear Participants,

Welcome to the first International ESAR conference in Hannover. The Accident Research Unit was founded by Harald TSCHERNE, Head of the Trauma Department of the Hannover Medical University more than 30 years ago. Special attention was always directed to an interdisciplinary teamwork between technicians and clinicians. From the beginning, technical AND clinical parameters were registered and analyzed. In addition, successful cooperations with other expert groups, for example in the field of Forensic Medicine, Psychology and General or Paediatric Surgery, were established.

From the beginning, Professor Dietmar OTTE was the motor of these cooperations. In the meantime, this model has been distributed and adapted to other countries and continents. Dietmar Ottes powerful and energetic leadership has pushed numerous projects. All over the world national and international networks are established.

Today, the first International ESAR conference is ready to start, reflecting many years of successful international cooperation between technicians and clinicians. The targets are still the same – to reduce the number of accidents and to save lives.

M. Mackay
 Professor Emeritus of Transport Safety,
 University of Birmingham, United Kingdom

Keynote lecture: The Evolution of Accident Research

Abstract

This paper reviews briefly the evolution of the investigation of transport accidents from the early beginnings when individual events were studied but systematic data was not collected. In the transport modes other than on the roads, accident investigation early on, even of single events, was important in introducing safety improvements. Road accidents, however, evolved enormously with the growth of car ownership without any comparable political response to the consequent deaths and injuries, equivalent to what happened with the other modes. From the 1950s data bases started to contribute to our knowledge of the epidemiology of road traffic injuries, and in-depth sample studies have contributed much to the body of knowledge in the last 30 years. However, even the basic input and output variables of a crash, its severity and the seriousness of the outcomes in terms of injuries and their consequences are not complete or agreed upon. Issues of experimental design and sampling are discussed. It is proposed that the most important area for current research to address is the effect of population variations on injury outcomes. The need for the establishment of good data bases for active safety issues is emphasised with the consequent need for better links between the research community and the police.

Early Origins of Accident Research

The origins of transport accident research are probably related to the domestication of the horse, when man started to travel at speeds of 30–40 km/hr, some 50,000 years ago. Certainly the Romans were concerned with conflicts and accidents between pedestrians and chariots, and amongst other remedial measures decided on a rule of the roads which was to drive on the left side.

The investigation of individual transport accidents began to become a profession when we started to

travel faster than a galloping horse, first by train and later by car. Thus in the 19th century railway accidents were sufficiently severe and sufficiently frequent to generate independent institutions responsible for accident investigation. In Britain for example, as well as a number of other European countries, a Railway Accident Investigation Board was created, independent of government, reporting directly to Parliament, with powers equivalent to those of the police. This was a precursor of the arguments as to the importance of independent crash investigation which continue to today in the air, marine and road sectors.

As these other modes of transport developed, accident investigation techniques also evolved. This was most noticeable with the rise of aviation, perhaps because flying is intrinsically a dangerous mode of travel, but also because as a predominantly passenger carrying commercial operation, there is an explicit contract between the carrier and its customers that the odds of arriving at their destination unharmed should be high. Thus commercial aviation became heavily regulated for safety reasons. Of particular interest today is that crashworthiness as a concept originated in aviation with the work of Hugh de HAVEN in the United States, and in 1942 John LANE in Australia suggested that aircraft should be certified in two ways, they should be both airworthy and crashworthy - hence the origin of the word crashworthiness.

The growth of road traffic with accompanying growth in crashes and injuries in the 20th century was by contrast a laissez-faire process. Responsibilities for crash investigation of road accidents rested in the first instance with the police, whilst general policies for road safety were usually attached to ministries of transport, but without clear mandates (or budgets) to provide safe road travel. Much folklore was generated about road accidents with policies aimed at changing driving behaviour through exhortation and training, without adequate evaluation of the effectiveness of such measures.

However, useful techniques evolved from the investigation of individual crashes. The examination of light bulb filaments, pedal prints, the application of Newtonian mechanics to calculate speeds from skid marks and the recognition by the legal process of the validity of such scientific analysis, began to set the basis for

accident investigation as a legitimate forensic profession.

The Epidemiology of Traffic Crashes

The growth in car ownership in the latter half of the twentieth century was one of the greatest changes in the social and physical fabric of our society, affecting our landscape, the nature of our cities, our relationships with each other, our work, shopping patterns, health and recreations. Allied with that growth in individual travel was a similar rise in traffic crashes and injuries. Basic data bases developed, originating from the police, from insurance companies and from hospital records.

The variables used to describe the characteristics of accidents and injuries in those data bases were, and still are, poorly defined and often very subjective. Collision severity for example is defined in police and insurance records in a purely qualitative manner – minor, moderate, severe, or total destruction, describing the nature of the damage to a vehicle. The first injury severity scale was – no blood, blood, alive, dead.

Even today for example most countries classify their traffic casualties as having slight, serious or fatal injuries. Yet the definition of for example “serious” varies greatly from country to country. See Table 1.

In looking at the response of governments and society to the growth in traffic crashes and injuries over the last 50 years, what is striking is the

Country	Serious: Fatal	Slight: Fatal
Austria	8	32
Belgium	7	31
Denmark	8	7
Finland	4	12
France	4	13
Germany	12	33
Greece	1.6	13
Italy	8	23
Ireland	5	15
Luxembourg	7	14
Netherlands	8	26
Portugal	4	18
Spain	5	9
Sweden	7	18
United Kingdom	9	49
European Union (15)	7	23

Tab. 1: Ratios of fatal to serious and slight casualties in EU countries. E.T.S.C. 1997 [1]

absence of the health dimension until relatively recently. Road safety was a matter for ministries of transport, who often gave the subject a low priority compared with building traffic capacity and efficiency to cope with the growth in road traffic. Accident research has been held back by folklore and good intentions unsupported by good science, and objective evaluation of the effectiveness of countermeasures. Looking back it is extraordinary how the health sector historically has contributed relatively little to the knowledge base of road accidents and injuries. Such organisations as the German Society for Traffic Medicine have been an exception, but in terms of governmental priorities in the health sector traffic injury has been largely neglected. That, however, is beginning to change in the face of an increasing recognition of the social and financial costs of road crashes, which in most European countries amount to some 1–3% of GDP. Witness the more rational approach of many governments now in terms of setting targets for casualty reduction and evaluating the various strategies put in place to achieve such targets.

Ad hoc Accident Research Studies

The main growth in traffic injuries took place between 1950 and 1980 in most of Europe and in that period there were many individual contributions to our knowledge of the details of traffic accidents and injuries. In Germany for example GÖGLER in Heidelberg started to bridge the gap between medicine and engineering by employing an engineer from Volkswagen to conduct detailed investigations in to how injuries were caused [2]. Volvo in Sweden established a programme to find out how Volvo cars actually performed in the real world. The German and Swedish insurance companies set up data bases to improve their knowledge of these events called road accidents gave rise to the costs which they were insuring. Small individual efforts at universities in Denmark, the UK, Sweden and elsewhere began to initiate in-depth studies to examine crash performance of cars, which lead to major improvements in such items as restraint design, door latch performance, the switch from toughened to laminated glass for windscreens, steering column performance and many other items. Such studies were often based on small samples of crashes, using limited statistical techniques and relatively primitive variables. It was commonplace for example for each research team

to develop their own injury severity scale, using such words, as minor, moderate, life-threatening, slight, serious, severe, disabling in many different ways, so that there was little compatibility between studies. The almost universal adoption of the A.I.S. has greatly diminished that problem, although its correct application varies significantly even today.

One of the most important events in the evolution of road accident research was the establishment of the United States Federal Motor Vehicle Safety Standards in the late 1960s and early 1970s. That created a need by other governments and the car industry worldwide to find out more about the developing problem of road traffic injury, and as a result many research programmes were initiated and new data bases evolved.

The Rise of Data Bases

Most countries began to recognise the limitations of police data, and intermediate level data sets, and began to fund more detailed crash investigation programmes. The most noteworthy has been the rise of the NASS/GDS system in the United States, evolving in the late 1970s and especially important as it is freely accessible to anyone. That data base, because it is open to anyone, has probably given rise to more accident research publications and contributed more knowledge to the subject than any other. Governments and other institutions who wish to maintain proprietary control over their own programmes should be persuaded to open their own data to others for more general use, by following the example of the US government.

The attraction of more accurate and more comprehensive data lead to the establishment of a number of in-depth programmes around Europe, notably in France at INRETS, in Germany with GIDAS and in the UK with CCIS. In addition a number of car manufacturers instigated their own in-house investigation teams. A similar move in the United States has lead recently to the CIREN programme. Common to all these activities was the recognition of bringing together as a team, engineers and doctors, together with other specialists, because fundamentally both disciplines are needed. Such research has been useful in evaluating the effectiveness of vehicle design changes, restraint benefits and limitations for example, understanding specific mechanisms

of injury, as well as drawing attention to emerging problems and new priorities. Such in-depth studies however always suffer from small sample sizes and skewed selection criteria. For example the CIREN programme is based on cases where an occupant is admitted to a major trauma centre. That in itself means that all the crashes examined involve a major injury, which limits the general applicability of any resulting analysis.

Beyond these data bases there are investigations of individual crashes, usually involving either large numbers of casualties or well known people. Such examples are major bus crashes such as the Tuen Mun Road Bridge accident in Hong Kong which killed 22 people, the M42 motorway accident in the UK which involved 170 vehicles, and the accident in Paris in which Princess Diana was killed which has resulted in major inquiries in two countries, costing so far several million euros. In addition product liability claims and other legal consequences of road crashes are leading to very detailed investigations and reconstructions beyond the resources of most academic or government institutions. Such events however can contribute significantly to the body of knowledge of accident research. An example of such a complicated reconstruction is illustrated in Figure 1.

Figure 1: An example of a reconstruction of an intersection collision between a tractor trailer combination travelling at 55mph and a car pulling out of a side road at 20mph. Because of the difficulties of accurately matching the initial points of contact with both vehicles moving, the reconstruction is made with the tractor trailer stationary at an angle of 18.5 degrees to the line of travel of the car. The car is pulled at a yaw angle of 69 degrees into it at 55mph. This is achieved by creating a very low friction surface between pads under the car's wheels and the metal surface of the

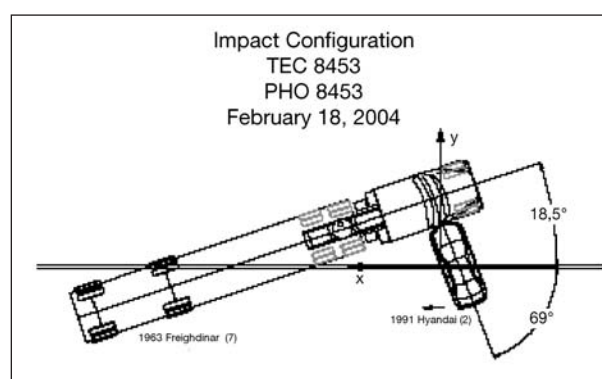

Figure 1

test track covered in soap. It allowed the car to engage solidly with the lateral aspect of its left front wheel against the tractor unit's right forward dual driving wheels, as occurred in the accident at the appropriate relative velocity and angle.

Current Issues

Basic Core Parameters

Fundamentally there are two basic variables in accident research. The input variable is the severity of the event, the outcome is the consequent injury or injuries. In spite of many attempts over the years these two variables are still poorly defined and imprecise. For the severity of the crash the most used variable is the change in velocity, Delta V. This variable is usually derived from measurements of crush of the vehicle structure and some knowledge of that structure's stiffness characteristics based on various crash tests. However, that process involves a number of approximations because any given impact in an accident differs from whatever standard crash test data that are available. The process itself involves measurements of the extent of the crush which in itself is only an approximation of the way in which a structure has been loaded. At higher and lower collision speeds than those covered by the standard crash tests at 50km/h, there is a small amount of data from experimental tests available. For narrow object impacts, particularly into the sides of vehicles, there is little available, and at low impact speeds where elastic rebound becomes important, coefficients of restitution are seldom known with any accuracy. Newtonian momentum and energy exchange calculations (using the EES for example) can be helpful, but this basic variable which defines the severity of a collision is still imprecise.

A second order problem is present in that such a parameter as the Delta V (or EES) is usually calculated as acting through the centre of gravity of a vehicle. The Delta V for a particular occupant, in the case where there is major rotation during the crash phase may be very different from which is occurring at the centre of gravity. Also if there is significant intrusion, the specific applied loads to an occupant and hence his Delta V within a zone of intrusion, can be greatly different from which is occurring at the centre of gravity. This applies frequently in the case of occupant on the struck side in a lateral collision for example. These factors are often ignored or not analysed in many studies.

A number of alternative parameters for assessing collision severity have been used. Mean acceleration is one example, or peak acceleration, derived from the mean acceleration by assuming a given pulse shape for the deceleration of the vehicle is another. Seat belt loads as derived from the load limiting devices in seat-belts has been used successfully in some specific instances [3], but in general none of these alternatives is totally satisfactory.

Crash recorders of various levels of complexity are now becoming widespread. Recent work by YDENIUS has demonstrated that there is a reasonable correlation between mean and peak accelerations, and that acceleration correlates well with injury risk. The duration of the crash pulse does not appear to be related to any increased risk, at least in comparing crashes with a pulse duration over 110ms compared with those of a shorter duration. Hence the use of Delta V, at least for collisions with roadside objects having long duration crash pulses is not a satisfactory parameter for assessing collision severity and injury risk [4].

Fortunately, with the widespread adoption of event recorders integrated into the central processing unit of a car's sensing systems there is now an opportunity developing for the recording of specific time/deceleration/direction histories of a collision. Hence there is also an opportunity for developing data bases in which better parameters for assessing crash severity are recorded. This technology is currently available but its widespread adoption depends more on social and legal issues than on technological complexity. However, it is already providing an interesting check on the accuracy or otherwise of conventional reconstruction techniques.

The second core parameter is the measurement of outcome from an accident, in terms of injury severity. In many ways this is a more complicated issue because injury severity has many dimensions. These can be threat to life, amount of tissue damage, loss of quality of life, cost of treatment, loss of physical function either temporary or permanent. The preferred scale which has been universally adopted is the Abbreviated Injury Scale (A.I.S.) which has the dimensions of threat to life and amount of tissue damage. This is an ordinal scale with categories 1 to 6 described as minor, moderate, serious, severe, life-threatening

survival probable, life-threatening survival uncertain, and currently untreatable (note that death is not a category). The latest 2004 version, like its predecessors, is a descriptive scale, essentially a listing of over 2000 injury descriptions and their agreed severity. This has the great virtue that it allows injuries to be classified in the same way by anyone, anywhere, making different data bases comparable [5]. This latest version of the A.I.S. is also linked to the Functional Capacity Index (FCI) which adds the capability of assessing the disabling, or loss of function consequences of a given injury as well. It is however, not a numerical scale, an AIS 4 injury is not twice as severe as an AIS 2 injury. You cannot produce an average AIS number of say 3.6 for a sample of patients, although some researchers have erroneously tried to do so.

In accident research the A.I.S. has proved to be an extremely useful parameter, but the conclusions drawn from its use have to be considered carefully. Is a brain injury of AIS 2, equivalent to a knee injury of AIS 2? This is clearly not the case when other dimensions are considered. The addition of the FCI will facilitate this distinction and allow multidimensional analyses, but it still illustrates the limitations of how to scale this extremely complex issue of the outcome of a collision.

Experimental Design and Sampling

Often data collection systems and projects are set up to provide insights into various aspects of traffic crashes without any clear numerical predictions being made as to the minimum number of cases needed to establish significant differences between specific outcome variables. To take a current example, what benefits are obtained by the addition of pretensioners to seat belts? Assuming a data base of crashes of all levels of injury severity to restrained occupants sampled at random, some in vehicles with pretensioners and some without. How many cases would be needed to establish a significant difference at the 5% level between the proportions of injuries at various injury severity levels? Clearly there are confounding factors such as age, gender, BMI, crash severity, presence of intrusion, collision type, presence or absence of airbags, etc. Examination of the data base numerically to allow for such factors will probably show that a surprisingly large number of cases will be needed to be collected before a comparable subset of cases is available. Likely several

thousand cases in the study design would be needed to meet the minimum cell sizes for a statistical difference to be detected.

With all in-depth accident data bases some sampling occurs. Usually such sampling is biased towards the more severe end of the injury spectrum, covering for example all fatalities in a given region in certain types of accident, a proportion of hospital admission cases and a smaller proportion of slight injury and damage only cases. To produce a sample of cases representative of the total population requires the introduction of weighting factors. Such factors depend on a knowledge of the total number of cases occurring in a given area which itself may be difficult to obtain. Also if a weighting up process is used then a few unusual cases in one cell may produce major distortions in a weighted sample. Purists point out that such weighting of samples should always weight downwards from the least number in a given category.

Many of the important insights into the characteristics of accidents and their consequences come from longitudinal comparisons between data sets which have been collected over several years. The NASS-GDS system in the United States was established in 1976 and continues to today. It has allowed countless studies of a comparative nature to be made where the introduction of new technologies or new regulations can be evaluated for their effectiveness. Europe has lagged badly in this regard in that no comparative systems exist on a European basis, and at national level such studies as are conducted are less comprehensive and often subject to changes which make longitudinal time series analyses difficult.

Injury Severity Risks and Population Variations

Experimental biomechanics has given us the standards parameters for the outputs from a dummy in a crash test – HIC <1000, Chest acceleration <60 g, Femur loading <1020 kg. These are mainly derived from experimental studies based on instrumented cadaver testing. Figure 2 shows such data for the risk of an AIS 4 compared with the HIC. Such data has been expanded to give insights into risk levels for other levels of injury severity in figure 3. What is largely missing from such analyses is the effect of population variations relating to the living

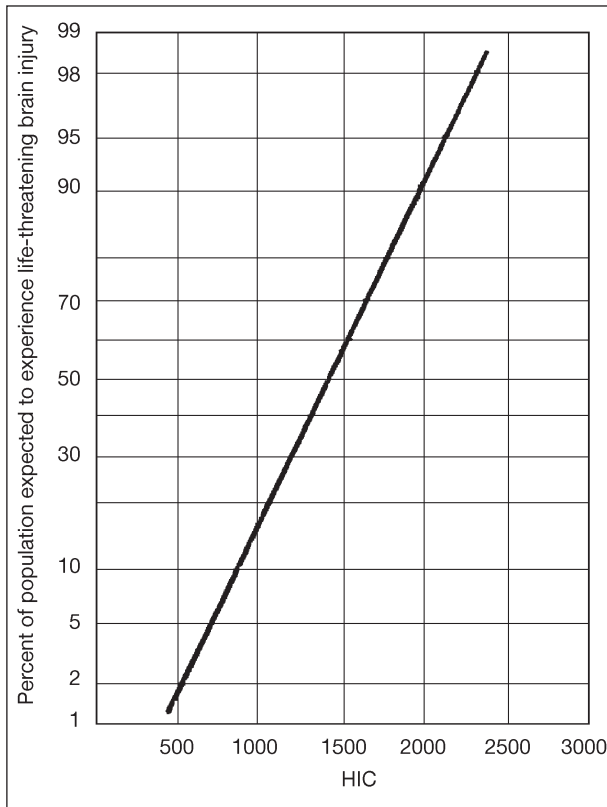

Fig 2: Risk for AIS 4 or Greater versus HIC Values

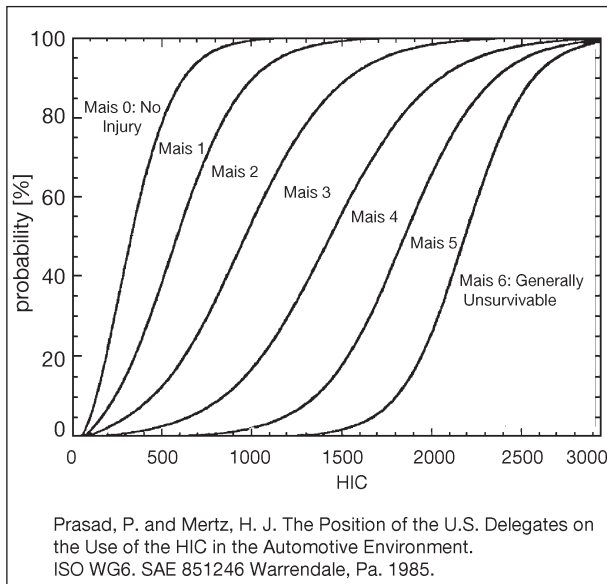

Fig. 3: Probabilities of Injuries at Various AIS Levels versus HIC Numbers

population having crashes in the real world. With the introduction of adaptable restraints, one of the most useful contributions which accident research can make at present is to describe the consequences of real population variations on injury risk. The key parameters are age, gender, height, weight, BMI. But there are probably subtle

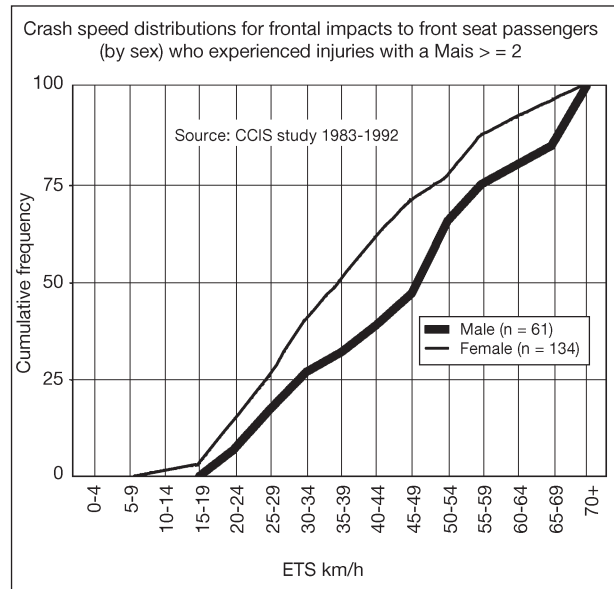

Fig. 4: Relationship of Gender to Delta v for MAIS ≥2 for Restrained Occupants

combinations of these parameters which come together to produce especially high or low levels of risk, together with additional factors such as physical fitness, state of health, alcohol and drug intake, clothing, and other factors. Small female drivers currently have to sit close to the steering wheel, and thus have been found in accident studies to be at higher risk of airbag related injuries in crashes. But tall, thin males have been found to be at more risk of belt related chest injuries than smaller males, probably because the path of the shoulder belt is lower across the rib cage and is thus loading the lower ribs which can be fractured more easily than those higher in the rib cage where the attachments to the sternum and the spine are more substantial and less cartilaginous [6].

Figures 4 and 5 illustrate some accident data which examine age and gender [7]. Gender differences for example show that a difference of some 10km/h is present between males and females to produce the same frequency of injury exposure. But whether such a difference is really the result of a gender difference or whether it is more of a second order consequence of sitting position and posture, and other factors is unclear.

These factors are of importance to the development of adaptable or smart restraints but they are particularly important in the context of the more general yardsticks which are used in designing crashworthiness into car. Current car design is largely driven by the need to obtain good ratings under the EuroNCAP scheme. For frontal

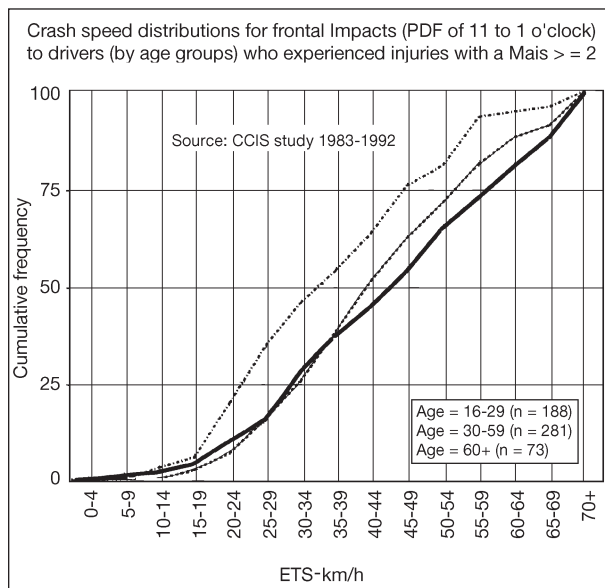

Fig. 5: Relationships between Age and Delta V for MAIS ≥ 2 for Restrained Occupants

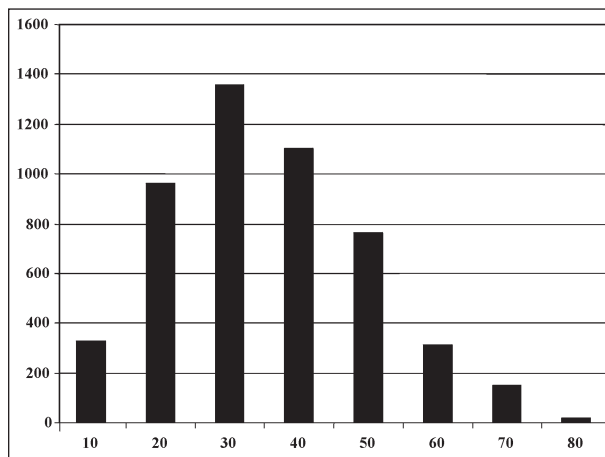

Fig. 6: Delta V in Km/h for AIS ≥ 3 for Restrained Occupants in Frontal Collisions

crash protection for example 64 km/h deformable offset barrier test sets the gold standard for protection in that type of collision. Accident data show that most collisions which cause AIS >3 injuries occur at Delta V severity which are much lower, figure 6. Real world data suggests that better design might be achieved by conceivably lowering the crash severity speed in the test but, more importantly lowering the acceptable injury criteria to perhaps HIC <750 , chest accelerations <50 g, and femur loads <750 kg. This is one example of the great importance of real world accident analysis and its effects directly on vehicle design.

Active Safety Data Bases

If you compare the resources and expertise which are deployed when serious and fatal crashes occur in the aviation, rail, maritime and industrial contexts, with what occurs with serious road accidents, even in the relatively advanced countries of the EU and North America, there is clearly a huge difference in approach. The sheer magnitude of serious road accidents has led to a fatalistic response at the political level, supported by a history of folklore about road accidents which still lingers on. The general acceptance of the systems approach coupled with the aspirations of Vision Zero as developed in Sweden, are now being reflected in most European countries, but the necessary data bases to actually gain more knowledge about causal factors and how they come together to cause road accidents are only just being established and we will hear more of those efforts in this conference. Active safety brings together other disciplines than automotive engineering and medicine, most importantly human factors engineering and highway design and management. But the need for good experimental design, well planned sampling structures, clarity in the use of the variables to be examined and hence adequate resources to obtain meaningful and statistically justified results are just as important as in other types of accident research. Accident research over the last 30 years has focused mainly on the general epidemiology of accidents and crash performance related to injury outcomes, such work must continue as there are many useful issues to examine, but active safety has been neglected and now is the time to change that. Hopefully resources will be available to make that happen.

One obvious, existing source of data is the information collected by the police throughout the EU. In many countries the level of expertise of the police and forensic scientists and engineers available and used, at least where fatalities are concerned, is very high. Yet such material is seldom used for research purposes or published in normal scientific journals. This represents an opportunity where the research community needs to cooperate with the police, take advantage of their expertise and develop the available data sources, only through working with the police and emergence services will good data bases be developed.

References

- 1 European Transport Safety Council, Transport Accident Costs and the Value of Safety. Brussels. Jan. 1997
- 2 E. GOGLER: Road Accidents. Series Chirurgica, Documenta Geigy. Geigy S.A., Basle, Switzerland, 1965
- 3 J.-Y. FORET-BRUNO et al.: Thoracic Injury Risk in Frontal Car Crashes with Occupant Restrained with Belt Load Limiter. Paper 983166, 42nd Stapp Conference. S.A.E. Warrendale, Penn., U.S.A. 1998
- 4 A. YDENIUS: Influence of Crash Pulse Duration on Injury Risk in Frontal Impacts Based on Real Life Crashes. Proc. IRCOBI Conf., Lyon, France. p. 155–166. 2002
- 5 T. GENNARELLI and E. WODZIN: Introducing the Abbreviated Injury Scale 2004. Proc. 5th Conf. Measuring the Burden of Injury. Baden bei Wien, Austria. p. 16–19, 2004
- 6 J. HILL, et al.: Chest and Abdominal Injuries Caused by Seat Belt Loading. *Accid. Anal. & Prev.*, Vol. 26, No. 1, p. 11–26, 1994
- 7 M. MACKAY: Intelligent Restraint Systems – What Characteristics Should they Have? Proc. AAAM/IRCOBI on Advances in Occupant Restraint Technologies. Lyon, France. p. 113–126. 1994

**Session: Regulation, Consumer Aspects and Methodologies –
Part I**

D. Otte

H. Hautzinger, M. Pfeiffer, J. Schmidt

M. C. Simon, T. Hermitte, P. White

F. Alonzo, M. Nguyen, J. P. Verries

D. Otte
 Accident Research Unit,
 Hannover Medical School, Germany

Possibilities of In-Depth Investigation Methodology for Injury and Accident Prevention on the Example of Car Accidents with Rollover – An In-Depth Analysis by GIDAS¹

Abstract

This paper describes the methodology of In-Depth Investigation in Germany on the example of GIDAS (German In-Depth Accident Study). Since 1999 in Germany a joint project between FAT (Forschungsvereinigung Automobil-technik or Automotive Industry Research Association) and BAST (Bundesanstalt für Strassenwesen or the Federal Road Research Institute) is being carried out in Hannover and Dresden. The methodology of this project is based on a statistically orientated procedure of data sampling (sampling plan, weighting factors). The paper describes the possibilities of such in-depth investigation on the results of the offered title. The accident cases were collected randomly within GIDAS at Hannover. There are more cases existing from previous investigation started in 1985 under the same methodology.

The portion of rollovers can be established at 3.7% of all accidents with casualties in the year 2000. For the study 434 cases of car accidents with rollovers are used for a detail comprehensive analysis. The accidents happened in the years 1994 to 2000 in the Hannover area. The injury distribution will report about 741 occupants with rollover accident event.

The presented paper will give an overview of the accident situations following in rollover movements of cars. The distributions of injury frequencies, injury severity AIS for the whole body and for the body regions of occupants will be presented and compared to technical details like the impact speed and the deformation pattern. The speed of the car was determined at the point of rollover and on the point of accident initiency. The

characteristics of the kinematics followed in a rollover movement are analyzed and the major defined types of rollover will be shown in the paper.

The paper will describe the possibilities of In-Depth Investigation methods for the approach of finding countermeasures on the example of car accidents with rollover and explaining the biomechanics of injuries in rollover movements.

Introduction

The participation in traffic is characterized by conflict situations that sometimes result in traffic accidents. About 20% of all accidents occur without the participation of others, mostly called solo-accidents. Especially noticeable within the group of solo-accidents, accident occurrences are those, where the vehicles slid sideways into the side part of the road and there sometimes rolled over. Publications show many indications relating to the corresponding severe injuries. Typically, the passengers did not use the safety belt, which is known to protect from the consequences of being ejected out of the car. Thus many of the publications on rollover injuries were written during the 60s and 70s, when the safety belt was not part of the standard equipment of cars. VIANO [1] reported that in the U.S. rollovers represent less than 5% of all vehicle crashes (NHTSA 1999), they account for approximately 15% of serious (AIS 3+) injuries and 20 to 25% of fatalities. 81% of two-away rollovers were single vehicle crashes. Even today, the majority of rollover accidents are reported from the Anglo-Saxon countries. In the recent years the number of persons killed in crashes reaches the highest level since 1990 driven by rollover fatalities likely due to the increase of the number of trucks and SUVs on the road and their increased likelihood to roll [KRATZKE et al. – 2]. Severe cervical spine and head injuries due to being ejected from the vehicle and the bodies hitting the ground outside the vehicle constituted the main injury focus points. Most serious and fatal injuries in rollovers result from ejection [PARTYKA 1979 – 3] and unbelted occupants have a higher risk of ejection than those belted, in cases of ejection 47% were severe or fatal injured (HIGHT 1972 – 4). It does turn out, though, that obviously the accident situations in the US are structured differently from the European countries. There the incidence of the accidents with resulting rollover is significantly lower frequent and also the severity of the injuries largely lower.

¹ cooperative study of FAT and BAST

In the traffic accidents happening in European countries a vehicle rollover does not mainly occur for solo-accidents, but also in the course of vehicle to vehicle accidents such after collision occurrences take place. Especially when 2 vehicles collide and in the course of the post-crash movement a change in friction between the tire and the road occurs, when the vehicle slide sideways either enters the unpaved verge or hits the curbstone sideways and this way a sideways overturning torque is implemented. Furthermore, there are accident situations, where vehicles climb the embankment next to the edge of the road and topple over due to the tilted plane. All these occurrences number among the group of rollover accidents. KOCHERSCHIEDT [5] reported that 2 to 5% of all accidents in Germany are rollovers, in a special study of BMW cars 20% rollovers were found. An influence of the driving speed could be analysed concerning the injury severity and the deformation depth. Also for German accidents it was pointed out by MILTNER [6] that there is in case of not using a seatbelt an high risk for ejection with 68%. In a study published lately on accidents involving guardrails, it was pointed out that the increasing use of noise barrier walls and dams has followed in an increase of such accident occurrences [OTTE – 7].

It is thus desired to determine the importance of accidents with resulting rollovers and especially identify the resulting injuries for the current accident occurrences on European roads, in order to implement special measures on the vehicle or in the road construction to limit the negative effects of rollovers and their pattern.

Approach

In order to investigate the accident occurrences of vehicles with rollover consequences more closely, the evaluations of in-depth investigations at the site of the accident can be used. This results in accident documentations that were started by a scientific team on-site and later added to in retrospect. These accidents can be chosen randomly, which can be counted as representative cross-sections of the real accident incidence using a statistic weighting process. The injuries are classified and documented and the damages to the vehicles are measured and recorded. Driving and collision speeds are calculated from the traces found at the accident site. Based on such an extensive analysis of the traffic accident incidence,

the consequences of roll-over accidents and the detailed vehicle movements can be reproduced.

Methodology of In-Depth Investigation GIDAS

In Germany as in many industrial countries, accident trends are presented annually based on the official national accident statistics. These accident statistics use the data from police accident reports. Although these statistics are useful, the limitation is that very little information about how accidents occur, the cause of the accident and the injury mechanisms is available. This limitation can be overcome by carrying out specialist in-depth accident investigations, collecting more detailed information than available in the police records. Such investigations begin immediately after the accident occurs. Specialist teams go directly to the scene of the accident to collect the necessary information to complete detailed accident reconstructions as well as the medical data about how the involved people were injured and treated. In this way, extensive information about a wide range of fields of research such as “vehicle design for passive and active safety“, “biomechanics“, “driver behavior“, “trauma medicine“, “rescue services“, “road design“ and “road conditions“ can be collected.

In Germany the first so-called “In-Depth Investigation Teams“ were initiated in the 1970s by German automakers. In 1973, the Federal Road Research Institute established an independent team at the Medical University of Hannover (in cooperation with the Technical University of Berlin). By 1984, this developed into a long term on-scene accident research study described by OTTE [8], based in a defined geographical area surrounding and including Hannover, which collected representative results. As of 1985, a target of 1000 accidents per year was set to form the basis for future evaluations. A statistical sample plan was used for selecting accidents for investigation and extensive information about the various aspects of the pre-accident, collision, and post-accident phases was collected and compiled into a database. The methodology and sample selection are described in the publication by OTTE et al. [9].

The value of in-depth accident research studies has been recognized internationally and many other countries also have such teams. Since such

detailed information is essential for improving the safety of cars, a strong collaboration with automakers developed. This resulted in a joint project called GIDAS (German In-Depth Accident Study) between FAT (Forschungsvereinigung Automobiltechnik or Automotive Industry Research Association) and BAST (Bundesanstalt für Straßenwesen or the Federal Road Research Institute) in 1999. In this project, the geographical area was extended and a second team was set up in the Dresden area providing additional cases from a different part of Germany. Both teams Hannover (MUH) and Dresden (TUD) function in the same manner using the same systems, procedures and collecting data in one common database of approximately 2000 cases annually.

Design and Methodology of the Accident Research Centers

Geographical Area of the Research Studies

The geographical area of the Hannover team covers the city and the surrounding rural areas within a diameter of approximately 80km (Figure 1). There are 1.2 million residents in this area and the surface area is approximately 2,289km². 10% is designated as urban.

The area Dresden includes the city of Dresden as well as parts of the counties within a diameter of approximately 60km. There are approximately 925,000 residents in the area and the surface area is approximately 2,575km².

Sample Plan – Randomly and Representative

Accidents involving personal injury are investigated according to a statistical sampling process. In both areas, the respective police, rescue services, and fire department headquarters report all accidents continuously to the research team. The team then selects accidents according to a strict selection process and investigates these cases following detailed procedures contained in a handbook and coding manual. In order to avoid any bias in the database, the data collected in the study is compared to the official accident statistics for the respective areas and weighting factors are calculated annually. This process explains why the data captured by the research teams can be seen as representative for their areas.

Statements about the national situation are only possible for those accident features that are relatively independent of regional influences. This is true for the variables which have an effect on the injuries sustained in crashes and therefore the findings from the study can be considered as representative for most aspects of passive safety.

Accident investigation takes place daily during two six-hour shifts following a two-week cycle.

This makes it possible to cover all periods of the day throughout the whole year for the random approach.

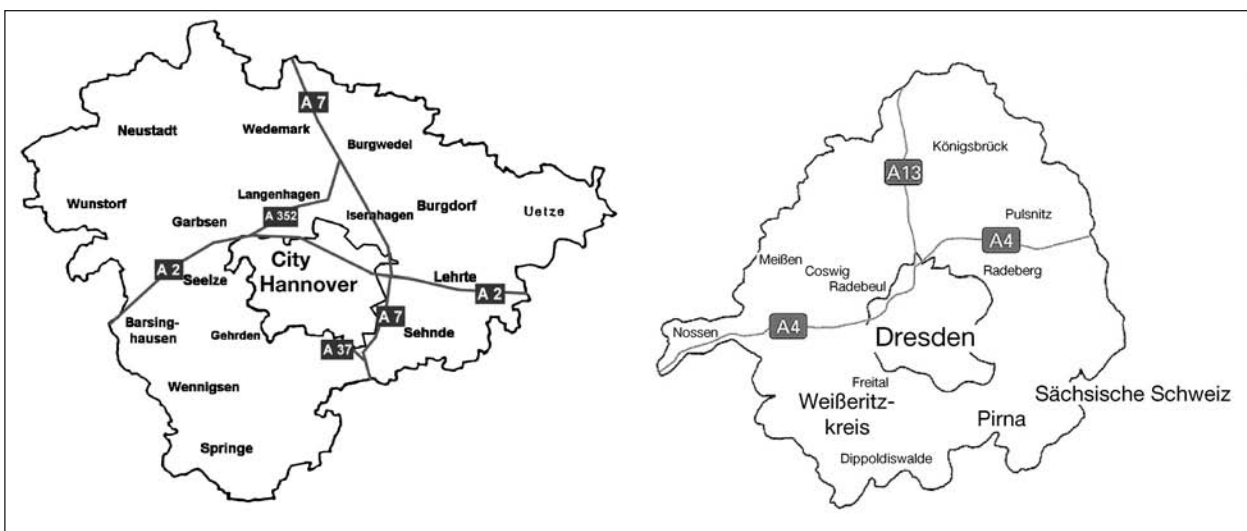

Fig. 1: In-depth Investigation Area Hannover and Dresden

Accident Team Structure, Equipment and Dataset

During each shift, a team consisting of two technicians, a doctor, and a coordinator is on duty. The coordinator manages the team by using the sample plan and the defined praxis orientated criteria “last happened accident in time” on the information list of accident events by the police dispatching centers. Each team Hannover and Dresden has two specially equipped vehicles available (Figure 2). These are equipped with flashing blue lights, sirens, special signals and emergency radio equipment. Various cameras and instruments are available for measuring and recording purposes. Accurate scale sketches of the scene of the accident are created using different techniques:

- hand measurement
- 2D photogrammetry
- 3D photogrammetry
- 3D laserscans
- GPS

The data are collected with forms and include such information as:

- environmental conditions
- road design
- traffic control
- accident details and cause of the accident
- crash information, e.g. driving and collision speed, Delta-v and EES, degree of deformation
- vehicle deformation
- impact contact points for passengers or pedestrians

- technical vehicle data
- information relating to the people involved, such as weight, height etc.

The information collected “on the scene“ is complemented by more detailed measurement of the vehicles (usually on the following day), further medical information about injuries and treatment and an extensive accident reconstruction generated from evidence collected at the accident scene.

By applying established physical principles, the impact events are reconstructed (e.g. collision speeds) using proven software such as PC-Crash². The output can be graphically displayed to allow a full understanding of the crash events (Figure 3). The movement in rollover can be analysed in correlation to the impacted zones on the vehicle and their time sequences.

Very important for the later analysis is the true to scale drawing produced by the measurement of the team at the scene.

Approximately 500 to 3,000 pieces of information per accident are obtained in total. Any personal data included is processed according to data protection regulations. Medical confidentiality and the rights of the individuals are guaranteed. All information is stored anonymously in database produced using SIR (Scientific Information Retrieval) software³ and is available for evaluation.

Different classification systems are used, i.e. AIS [10], CDC [11], Polytrauma Score [12], and other scores [OTTE – 13].



Fig. 2: Vehicles for In-Depth Research and In-Depth Team on Scene

² Steffan Datentechnik, Graz

³ Scientific Information Retrieval, Sydney

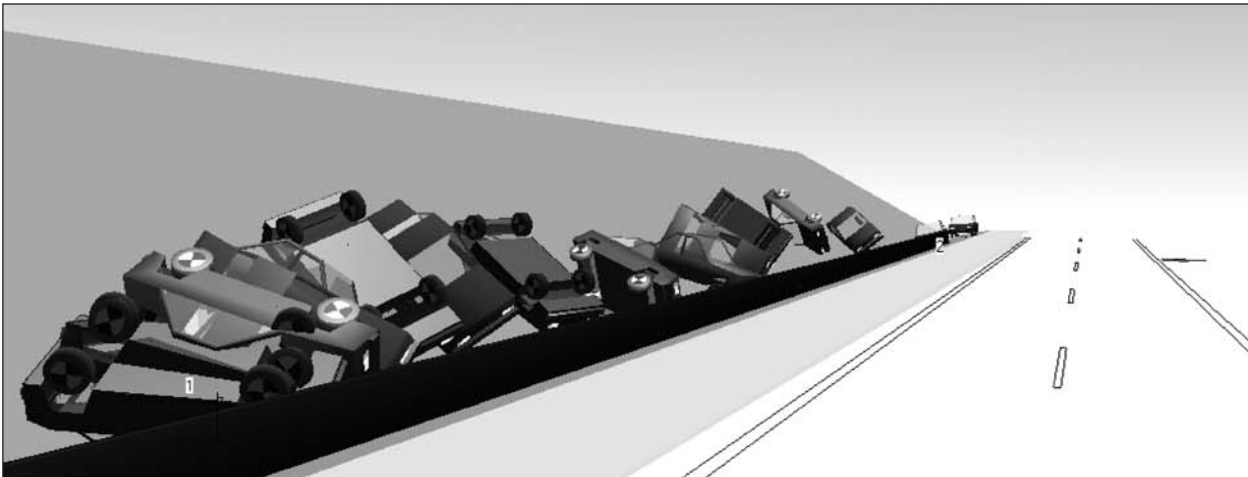

Fig. 3: Reconstruction by Simulation on the Basis of a True to Scale Drawing

Basic Material for Rollover Study

For the analysis of car accidents with rollover consequence 6,713 accidents from the years 1994–2000 from the accident sample collected in Hannover were evaluated, altogether 7,846 cars participated with 11,361 passengers, of these 434 cars resulted in a rollover. A rollover was defined to be a movement of the car, where the vertical axis of the vehicle turned at least 90° around the longitudinal or transverse axis to its final position. Thus 434 cars and 741 occupants with rollover constitute the basis of the study.

For these cases, an extensive in-depth analysis of the rollover incidents in the course of an analysis of individual cases was conducted. There, special information based on the existing accident reconstruction details and of a scaled drawing of the accident location was used for the analysis of amongst others:

- position of the individual impact on the vehicle
- direction of load at each impact
- deformation depth at the place of each impact
- estimated energetic reduction in velocity as a consequence of each impact
- location of each impact
- direction of load in relationship to the centre of gravity for each impact
- injuries in the course of each impact and place of impact inside the vehicle

Additionally, in order to allow a comparison of the results from this paper with other scientific

publications, the vehicle movement, where the rollover is concerned, was classified according to NASS (National Accident Sampling System), where a total of 11 different types of rollovers was differentiated (Figure 4).

PARENTAU et al. [14] made a careful study of NASS data and used the rollover-type classification of NASS, they found that currently developed trip-over and fall-over tests reflect the largest proportion of rollovers in the field. All impacts of vehicles within a rollover were recorded in chronological order and the driving velocity at the start of the first traces and at the point, when the vehicles left the road as well as points of rollover impacts were calculated. The frequencies of results will be presented with the percentage in weighted form and the numbers in absolute existing values. The injury severity is used by AIS (Association of Automotive Medicine) and used in the presented diagrams as 3 groups from minor (AIS 1), severe (AIS 2 to 4) and worst/fatal (AIS 5 and 6), with this classification a 90% correlation does exist to the definition of the national statistics based on police reports [OTTE –13]. For describing the risk of a rollover event the frequencies of rollover cases are compared to those of non rollover cases documented in the whole GIDAS sample (434 cases versus 7412 cases).

Typology of Rollover Accidents

Frequency Distribution

The proportion of the rollovers for accidents with personal injury was 5.8% in 1994. A constant decrease is visible up to today. In the year 2000 the proportion of rollovers was 3.7%.

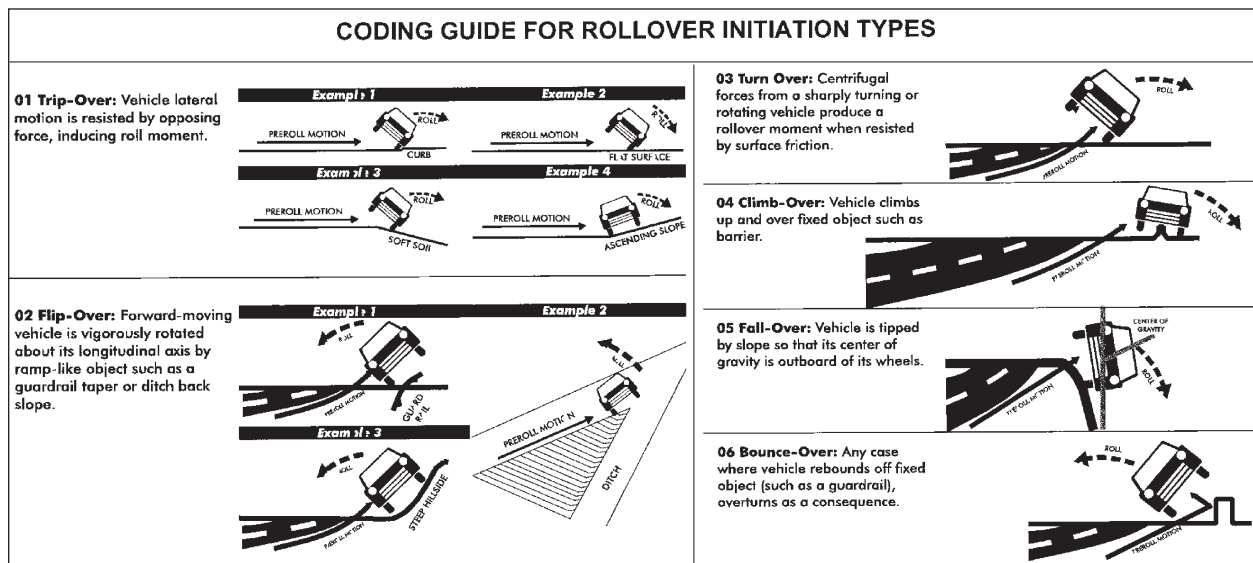

Fig. 4: Classification of Rollovers (NASS-Data sampling)

Rollovers mainly occur in the course of accidents outside of city limits and on freeways (Autobahn), but the portion of rollovers changed over the years with an increase on rural streets and a decrease for the urban area. Thus the proportion of accidents with rollover consequences in 1994 outside of city limits (rural) amounted to 14.9%, on freeways 21.3% and within city limits (urban) only 1.5%, whereas in 2000 12.3% of the accidents with personal injury on freeways, 9.9% of the accidents outside of city limits and a small percentage of 0.8% of the accidents within city limits resulted in a rollover. An influence of the production year of the participating cars could not be found in the study. The same year of manufacture distribution was registered for vehicles with rollover as without rollover. But a difference was obviously concerning the type of the car model, where 4.5% of the small cars, 3.4% of the mid-size and 3.5% of the luxury class cars were involved in a rollover, the percentage of rollovers for so-called vans and off-road-vehicles was at remarkable 11%. For convertibles there was also a higher risk of rollovers, of the cars involved in accidents 1.8% of those without rollover and 2.6% of those with rollover were convertibles. Most of the accidents involving rollovers occurred at night. 5.4% of the accidents happening at night resulted in a rollover, in contrast 3.8% occurred in the daytime and 4% during dawn or dusk. 13.7% of the accidents in curves, 6.7% on straight sections and 1.2% at intersections included a rollover. Thus the risk of suffering an accident with rollover consequences is significantly larger for curved road sections, but the

evaluations also showed that from an absolute point of view accidents with rollovers occur mostly on straight sections (63.3%), whereas only 19.9% of the accidents with rollover consequences occurred in a curved area. 14.3% happened at intersections. The structure of the accidents with rollover consequence is thus largely determined by accidents on straight sections and at intersections (78% of all rollover accidents).

Causes of Rollovers

A rollover of a vehicle is the consequence of high lateral angular speed, caused by suddenly occurring great deceleration forces between tires and road surface. They can thus be the result of different friction values (μ -split) or of a sudden hooking in the area of the wheels, i.e. when sliding against a curb. In 3.0% of the cases with rollover a curbstone was evident as cause of the rollover (Figure 5). In 38.0% the car was swerved under μ -constant or μ -split conditions, in 45.4% a sliding into an embankment downwards or upwards could be established. In 13.7% a pre-impact with another vehicle implemented the rollover movement.

In 69.5% grass and only in 1.4% gravel on the side of the road were registered for rollover accidents. In only 20.2% of the cases the levels of the rollover surface and the road surface were even (Figure 6).

One third of all rollover events (34.3%) happened on field surfaces, collision objects like trees (1.8%)

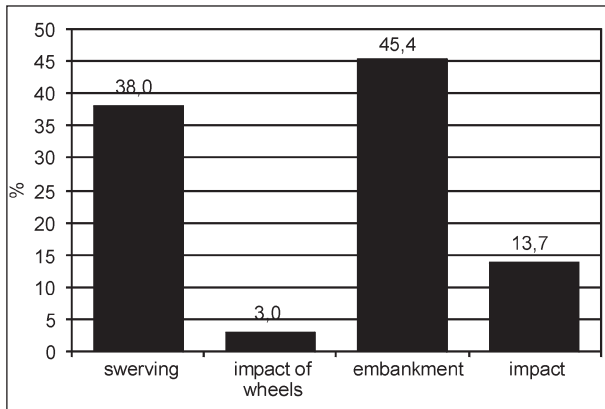

Fig. 5: Cause of Rollover of n=411 Cars (n=23 Unknown)

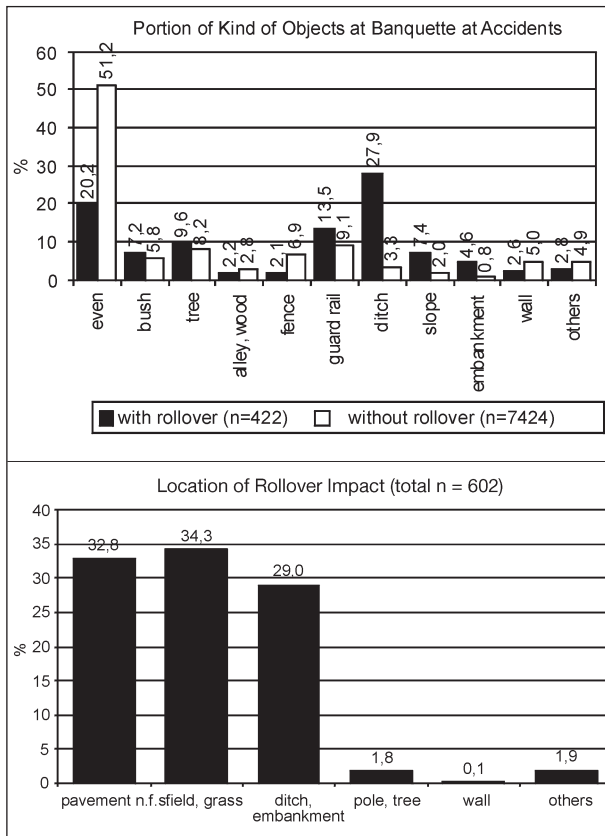

Fig. 6: Frequencies of Object Struck at Banquette in Car Accidents with and without Rollover

and walls (0.1%) were rare. A ditch and an embankment (29%) could be seen often as impact object.

This resulted in the greatest risks for a rollover in case of a ditch running parallel to the side of the road, into which the skidding vehicle slid (27.4% of the accidents with rollovers happened at road sections with ditches related to 3.3% of accidents without rollover). In the course of the study it was thus shown that rollover accidents of cars mainly

occur outside the city on country roads, 95% of all impact objects in the course of such an accident occurrence are situated at underground of pavement, field, grass, ditch and embankment.

Place and Severity of Injuries

Accidents with rollover consequences result in injuries more frequently than those without rollover. For accidents with rollover (maximum injury severity per car) only 5.0% of the passengers in the car remained uninjured. In contrast, for all accidents with personal injuries 55.6% of the passengers in the car remained uninjured. 37.4% of the passengers in the car suffered injuries of the degree of severity MAIS 1 (with rollover 66.8%) and were thus classified as slightly injured (outpatient), 6.4% suffered MAIS 2 to 4 (with rollover 25.8%) and 0.6 % suffered degrees of severity MAIS 5/6 (with rollover 2.4%).

In case of rollovers 68.7% of the vehicles were involved in just one impact, 23.5% in two impacts, 7.5 % in three impacts and 0.4% in more than three impacts. The severity of the injuries shows clearly that an increase of the number of impacts results in an increase of the severity of the injuries. For one impact only 28% showed injuries of severity MAIS 2 and higher (MAIS 2+), for three impacts this number had increased to 43%. It also turned out that a rollover on the road surface results with a probability of 30% in injuries of the type MAIS 2+, a rollover at the side of the road however does not necessarily increase the severity of the injuries. Frequently in such cases even lower degrees of injury severity occurred. Thus only 28% of the rollovers in the paved embankment and merely 18% in the unpaved embankment were related to injuries of severity MAIS 2+.

Belted occupants have a lower risk for ejection (Figure 7). 1.6% of the belted drivers and 2.4% of the belted frontseat passengers ejected during the rollover movement, compared to this 31.9% of the unbelted drivers were thrown out of their vehicles. The presented occupation distribution gives a 79.5% reduction for the driver of severe injuries MAIS 3+ by wearing a seatbelt.

The type of the collision object and the place of impact on the vehicle seem to be of importance for the severity of the injuries. Concerning the place of impact on the vehicle, the vehicles were subdivided into different zones for the purpose of this study. The sides of the vehicles were

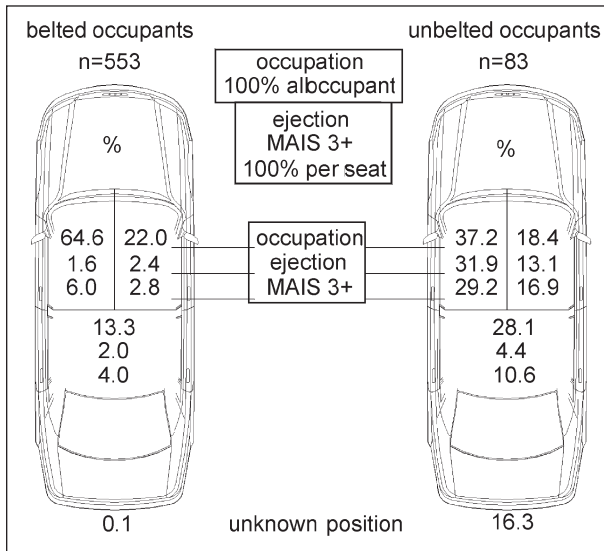

Fig. 7: Occupation Distribution, Proportion of Ejection and Injury Situation of Cars with Rollover

subdivided into 6 different zones A–F and the vehicle as seen from above was divided into left – centre – right. This resulted in the frequency distribution of the places of impact on the vehicles depicted in figure 8a–c. It is visible that an impact zone that occurred very frequently was the front part of the car (A) and at still 15.4% also the position of the driver (BL) as impact zone of the first impact in the course of the rollovers. Especially the position of the driver is also that with the most severe injuries. 42% of the passengers suffered injuries of a degree of severity MAIS 2+.

A rollover is mostly characterized by several different places of impact on the vehicle. A second impact in the course of the rollover was determined on very few parts of the vehicles (figure 8b). Mostly there were places of secondary impact on BL, BM, BR zones, thus in the area of the front passenger seat with approximately 18% each. Here, the severity of the injuries was usually significantly higher for the area of the passenger cell than outside the compartment. Only the third impact in the course of the rollover phase (figure 8c) occurred mainly in the rear area of the passenger compartment (CL, CM, CR) but still also in the area of the front passenger seat at 16% (BR). The most severe injuries were mostly registered in the course of the third impact, if this impact occurred in the front part in front of the passenger cell (AL, AM, AR).

13.8% of the injuries of car occupants were caused by the windscreen, 10.2% by the dashboard and 5.7% by the steering wheel (Figure 9). Side glasses

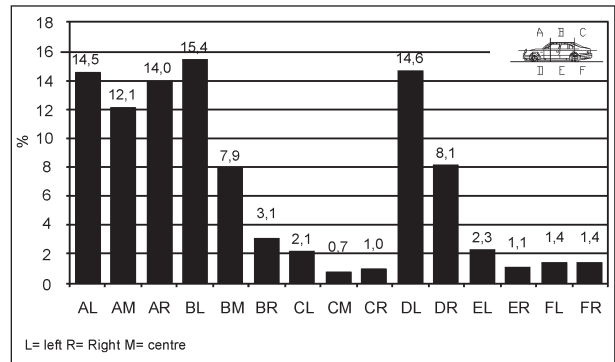

Fig. 8a: Impact Zones at Car (First Impact within Rollover Movement – n=599)

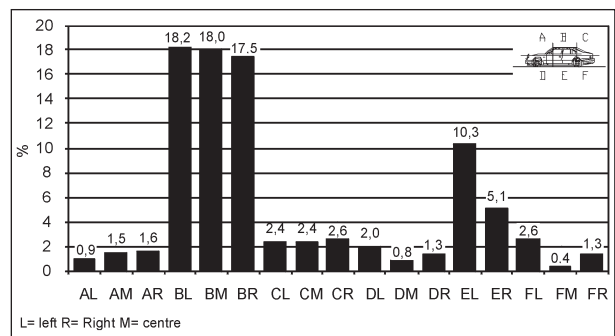

Fig. 8b: Impact Zones at Car (Second Impact within Rollover Movement – n=534)

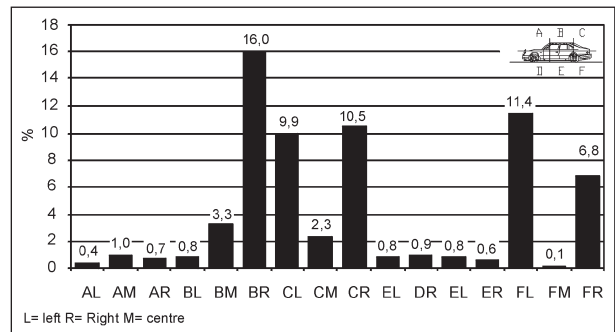

Fig. 8c: Impact Zones at Car (Third Impact within Rollover Movement – n=391)

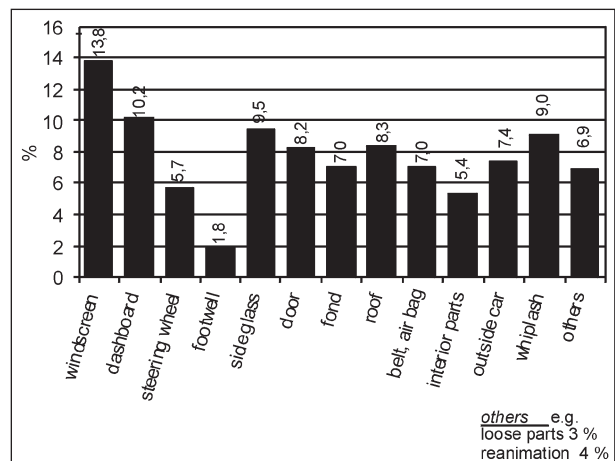

Fig. 9: Injury Causing Parts of Car Occupants in Rollovers (n=408 Injuries Caused by Rollover)

of the vehicle caused 9.5% of the injuries within rollovers and 8.3% were registered as the roof parts. Remarkable is the fact that 7.4% of the injuries were caused outside the vehicle and 9 % were non contact injuries called “whiplash injuries”.

Kinematics and Characteristics of the Rollovers

Concerning the typing of the rollover according to NASS classification it turns out that the most common accident type at 29.7 % is the Trip-Over type 3 (figure 10). This is a type of accident where the rollover occurs on a gradient with soft surface and a sideways tilting vehicle. This type is followed by the type Trip-Over 2 at 17.6%, where the vehicle skids sideways on a flat surface and topples over. All others of a total of 11 different types according to NASS occur at low frequencies. The type Flip-Over 2 occurs relatively frequently too at 9.8%, where a vehicle moves mainly along the longitudinal axis of the vehicle, reaches a ditch by rotating around its longitudinal axis and topples over.

Accidents in the shape of a rollover characteristic with a sideways knock are not very frequent (Trip-Over 1 - 5.7%, Flip-Over 1 - 1.2%, Bounce-Over – 4.1%), and they seemed especially minor (figure 11). Approximately 30 to 50% of these resulted in injured occupants (MAIS >0). The lower severity of injuries can be explained by the more rotational speed the tilting car undergoes. In other types of rollover the impact to the car body suffers high

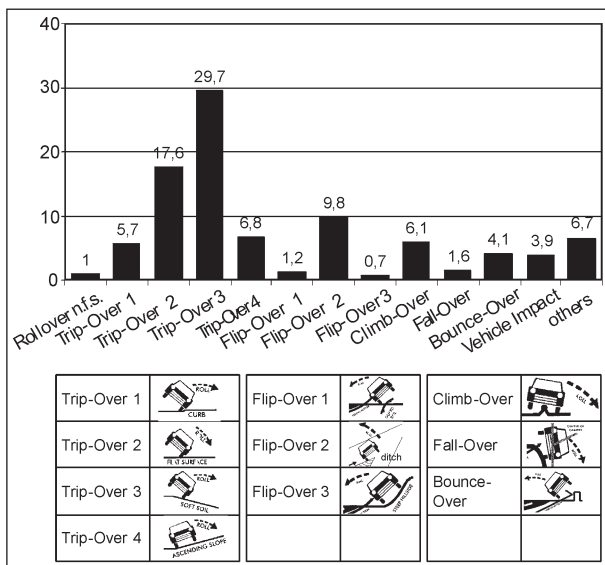

Fig. 10: Frequencies of Different Rollover- Types (NASS Classification), n=422

deceleration loads. Regarding the resulting severity of injury, out of the accident types with increased frequency, the Trip-Over 2 – which is very frequent too – seems to cause the worst injuries (36% MAIS 2+). Especially remarkable in its complete distribution concerning the severity of injuries is the Flip-Over 3, where a vehicle falls sideways off the road onto a significantly lower terrain. The type Fall-Over is also remarkable, it has the lowest percentage of soft part injuries. The subsequent roof impact is correspondingly usually massive. In 56% of the cases rollover occurs over the left side of the vehicle. No significant change of the resulting severity of the injuries in relation to the side of the rollover was found.

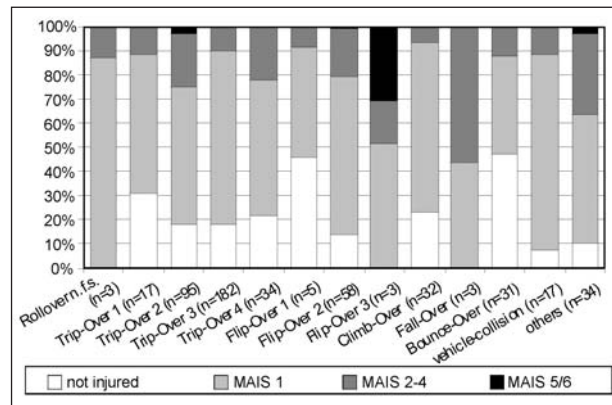

Fig. 11: Injury Severity Grades of Belted not Ejected Occupants for Different Kinds of Rollover

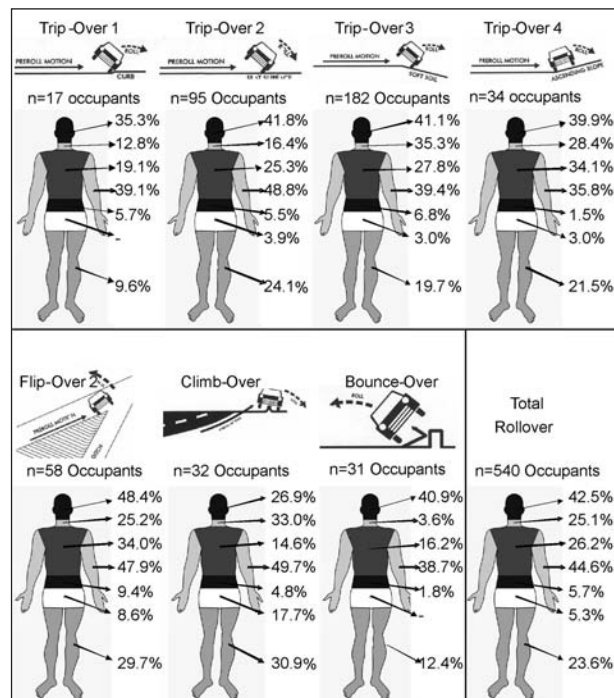

Fig. 12: Frequencies of Injured Body Regions of Belted not Ejected Occupants for Different Kinds of Rollover (100% all Occupants Each Group)

Injuries on the body after a rollover had taken place mainly on head, thorax and arms. 42.5% of the belted not ejected occupants in car accidents resulting in a rollover were injured on the head, 26.2% on the thorax and 44.6% at the upper extremities. In comparison with the injury image of belted occupants in car accidents without a rollover, there 34.5% of head, 30.9% of thorax and 18.4% of arm injuries occurred. It was thus shown that under rollover conditions the risk for head and especially for arms is much higher.

63% of the vehicles with rollover skidded at the time the accident started, 90% of the vehicles were driven at velocities exceeding 60 km/h at the moment the accident started. Thus a high driving speed is a typical feature of accidents with rollover consequences (figure 13). Whereas for accidents without rollover consequences 90% of the vehicles were driven at speeds exceeding 10 km/h and 70% were doing less than 60 km/h the moment the accident started. 90% of the speed values of cars with rollover were calculated above 60 km/h. On the other hand, the analysis of collision speeds of the vehicles with and without rollover did not show any significantly deviating velocity distribution. 80% of the vehicles with rollover primarily collided in the course of the accident primarily at speeds of up to 52 km/h, without rollover it was 60 km/h. This means that obviously a large amount of speed can be dissipated after the accident has started, up to the point of collision in the course of the skid movement.

Very rarely more than one complete turn occurred in the course of rollovers. 16.7% were classified as 1/4-rotation, 52.1% as 1/2-rotation, 6.5% as 3/4-rotation. Only in 4% of the cases more than a

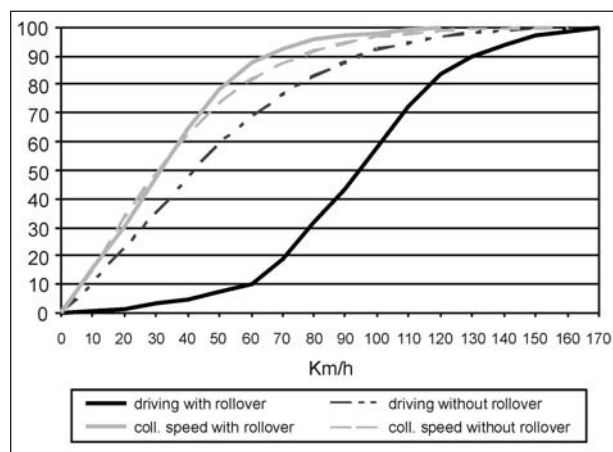

Fig. 13: Cumulative Frequencies of Driving Speeds of Cars Before Reaction and Collision Speeds

complete rotation of the vehicle was found. 88% of the rollovers were consequences of previously occurred primary collisions.

Deformation Pattern on the Vehicle and Influence on the Severity of the Injuries

The deformation depth of each impact was measured in the direction of the impact load. Deformations of up to 60cm occurred by rollovers. Only a small influence of the deformation depth on the resulting severity of the injuries MAIS for the belted occupants was apparent (figure 14). 80% of the severely injured belted occupants MAIS 5/6 as well as 80% of the MAIS 1 minor injured belted occupants suffered within the rollover, deformation depths of up to 15 cm.

Each deformation on the car was related to the number of impact during the rollover movement as primary, secondary or third contact. The deformation was measured with the deformation depth and assessed concerning the suffered speed change during this impact; this was done by an EES-value (energy equivalent speed), even this could not be done exactly and in a physical allowed manner for rollover impacts. In rollover cases EES represents an assessment of the deformation volume of the impact during the rollover movement. 80% of the values for impacts by the rollover can be found up to rollover-EES 15km/h (figure 15). Similar distributions in the cumulative frequency curves of this value can be seen for primary, secondary or third contact. In contrast to this 80% of the EES-values for cars with no rollover were calculated above EES 10 km/h.

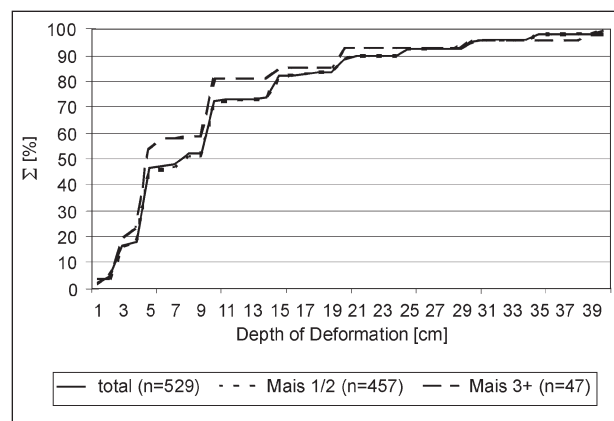

Fig. 14: Cumulative Frequencies of Depth of Deformation over Different Injury Severity Grades for Belted not Ejected Occupants

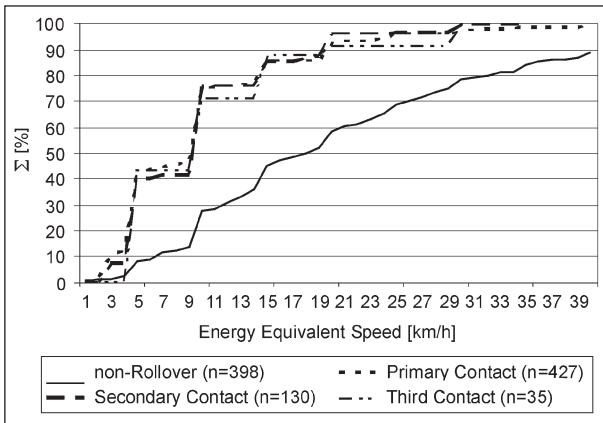

Fig. 15: Cumulative Frequencies of Deformation Energy Assessed by EES for Cars with Rollover for Different Impact Situations

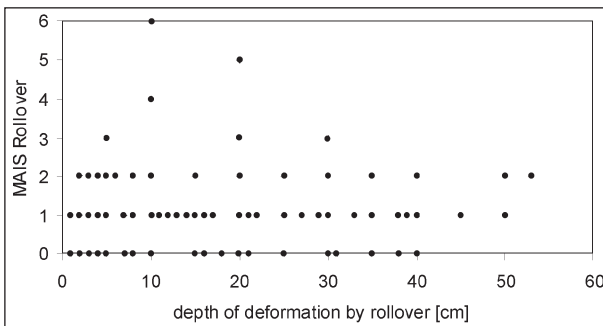

Fig. 16: Injury Severity MAIS of Rollover Related Injuries and the Depth of Deformation of those Contact Points on the Cars with Rollover (n=529)

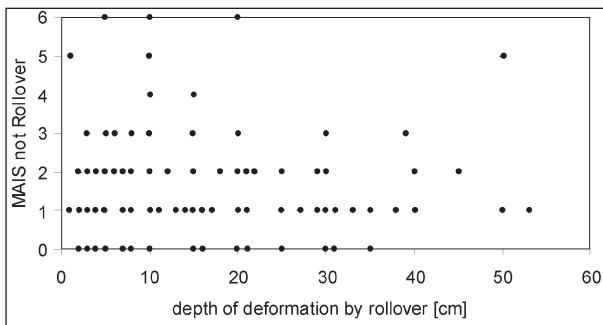

Fig. 17: Injury Severity MAIS of Non-Rollover Related Injuries and the Depth of Deformation of those Contact Points on the Cars with Rollover (n=517)

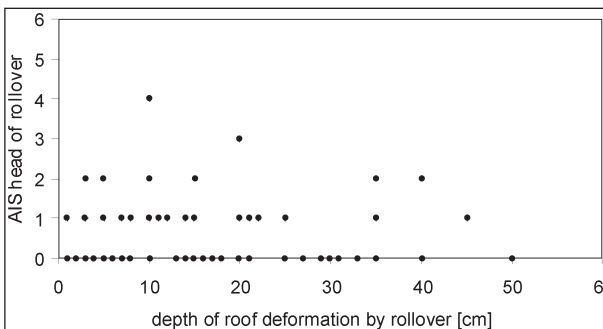

Fig. 18: Injury Severity of the Head of Occupants with Rollover Related Injuries and the Depth of Deformation of those Contact Points on the Cars with Rollover (n=438)

For the analysis of the injury severity related to the rollover movement, a special MAIS was built for all rollover related injuries. The so-called “MAIS rollover” was plotted in a diagram related to the depths of deformation by rollovers (figure 16). The injury severities by rollovers are for belted occupants mostly not above MAIS 2 and there are many uninjured occupants within a rollover movement.

Compared to the injury severity of rollover related deformations the injury severities of non rollover related deformations following in more significant correlation of these two parameters (figure 17). Larger deformations are mostly linked with higher injury severities for deformations not related to rollovers.

From this analysis it can be seen that the MAIS is mainly presenting the injury severity of the head (figure 18), because the head is exposed as flexible extremity part for the injury risk. The distribution shown in figures 13 and 15 are nearly the same. It can be pointed out from the diagrams that the risk for severe head injuries AIS 3+ is starting for belted occupants with roof deformation depths of above 30cm.

Characteristics of the Accident Set-Offs

From the detailed documents of the accident reconstructions, especially the in-scale drawing of the traces found on the accident site, such as brake and skid traces, the take-off angle of the road surface, the skid, brake/skid distance could be determined and the period of time from hitting the brake to the point of the primary impact could be calculated. Mainly very small angle deviations from the longitudinal axis of the road occurred, when the vehicle left the road towards the side. 65% of the vehicles left the road at an angle of less than 5 degrees (figure 19).

Angles of more than 25 degrees occurred only in 5% of the cases. This means that the take-off angle for accidents with rollover consequences does not exceed 25 degrees. An attitude angle for the vehicle to the left of up to 80% between 0 and 130 degrees as well as to the right between 0 and 110 degrees can be determined (figure 20).

For 80% of the accidents with rollover consequences a time of up to 4.3 seconds elapsed from the start of the accident to the first impact during rollover. In only approx. 10% of the cases periods of more than 5 seconds elapsed (figure 21).

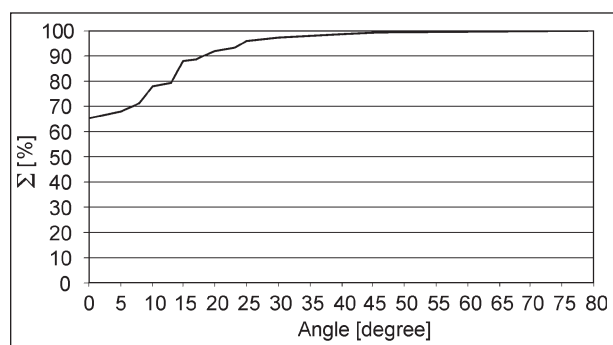

Fig. 19: Angle of Running off the Roadway (n=334). This angle exists between the direction of car's centre of gravity and the direction of the road when leaving the roadway

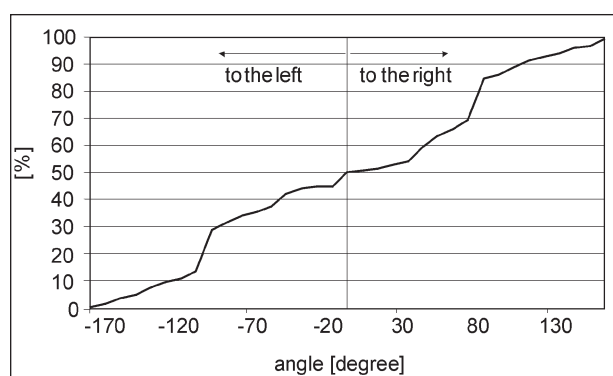

Fig. 20: Cumulative Frequencies of Attitude Angle at Rollover (n=409)

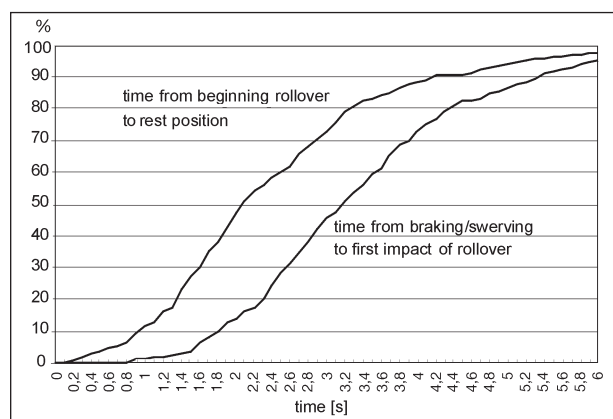

Fig. 21: Cumulative Frequencies over time from the Beginning of the Breaking/Swerving Movement to the First Impact in the Course of the Rollover (n=308) and the Whole Time Duration until the Rest Position of the Car (n=295)

For the whole movement of a rollover a time duration of 1 to 4 seconds (90%) can be seen as useful in real accidents.

Conclusion

Rollovers are found in the traffic scenery in different situations, some are the result of a high rotation of the car and an increase of friction between tires

and the road surface, others are the effect of a sudden hooking in the area of the wheels. For the German accident situation the study pointed out that a rollover could be observed in 3.7% of the accidents with casualties and that the percentage has been reduced over the years to the current state. It can be awaited in the future the number of rollovers accidents will further decrease regarding the fact that many vehicles will be equipped with ESP (electronic sliding protection). In the accident sample there was no ESP-equipped car with a rollover registered. The portion of rollover events are at 11% remarkable high for vans and off-road-vehicles and the portion is increasing. Rollovers mainly occur in connection with accidents on straight road sections and at intersections (78% of all rollover accidents), 20% occurred in a curved section. Ditches and Embankments are at 29% beside the unpaved surfaces of fields or pastures the most frequent collision object within a rollover movement, an impact against trees or walls can be seen only in less than 2%. Nearly 95% of all impacts within a rollover occur on flat surfaces. Comparing accident situations with and without rollover the highest risk for rollovers can be established for ditches. 88% of the rollovers were consequences of previously occurred primary collisions with other vehicles.

The type of the collision object and the place of impact on the vehicle as well as the number of impacts within a rollover movement influence the injury outcome. The position of the driver is often hit first, the second impact zone being the roof of the vehicle, while the rear of the roof is more often hit third. The position of the driver is with the one, where the most severe injuries occur.

The study shows that 3 different types of rollover make up nearly two thirds of all rollover cases: firstly the so-called "Trip-over, describing a lateral movement of the vehicle on a downward sloping ramp" at 30%, this is also the one with the highest injury risk for head injuries. The study came to the same results as PARENTAU et al. [14] pointed out for the US situation, that trip-over reflect the largest proportion of rollover in the field. But in contrast to PARENTAU who confirmed also the Fall-over test conditions as one major accident type, the presented study pointed out that rollovers in the characteristic of a lateral sideways movement and rotation via the longitudinal axis under forward movement are also frequent and severe. For the replication of frequent and severe real life rollover accidents a screwed movement of the car on a

ramp via the longitudinal forward movement should be proposed as test procedure. This corresponds to examinations of BERG et al. [15].

Only a small influence of the deformation depth on the resulting severity of the injuries MAIS was apparent. 80% of the severely injured occupants MAIS 5/6 as well as 80% of the MAIS 1 minor injured occupants suffered within the rollover, deformation depths of up to 15 cm. The risk for severe head injuries AIS 3+ is starting at roof deformation above 30cm.

The study has shown that for belted occupants in the current accident situation, there is with 3% of accidents with casualties a low risk to be injured in a rollover movement on German roads, a probability of 90% to suffer an injury severity of up to MAIS 2 does exist. In case of belt usage the risk of ejection is very low too, only 1.6% of belted drivers were known out of their vehicles.

The conclusions from the study can be formulated as follows:

1. Accident prevention

- avoidance of vehicle sliding (63% of cars with a rollover slipped before the rollover)
- reduction of driving speed (80% of cars with a rollover were driven >70km/h)
- reduction of high friction values in the areas of the wheels (38% of accidents with rollovers were initiated by lateral sliding effect μ - and μ -split)
- recommendation for the implementation of a paved flat strip beside the road on the same height-level

2. Injury prevention

- development of stiffer interior structures of the vehicle cell, especially avoidance of the roof deformations >30 cm
- use of seatbelts, implemented with pre-powered pull tight devices
- positioning of padding together with additional implemented airbags in lateral head and roof position

The presented study gives the frame conditions of rollover kinematics and injury mechanisms on the one hand and describes the time window for developing optimized sensor systems for the avoidance of a rollover and the reduction of the injury severity within a rollover movement. For 80%

of the accidents with rollover consequences a time of up to 4.3 seconds elapsed from the start of the accident to the first impact during rollover. In only approx. 10% of the cases periods of more than 5 seconds elapsed. This brings strategies of accidents avoidance in the main focal point of interest, there could be enough time for activating intelligent sensor technique. Herewith the paper describes the possibilities of in-depth investigation by an interdisciplinary team of researchers, starting the investigation directly after the event. From the detailed analysis of existing traces and the documentation of deformation and injuries the movement of a vehicle within the event can be reconstructed and the injury pattern can be explained. Important parameter for the further development of safety measures and the practise of crash tests can be collected by such in-depth investigation tool.

In-depth investigations are always necessary for assessing detailed information of traffic accidents. Such detailed documentations are not available from the usual statistics of traffic accidents which are based on police protocols. Therefore special teams trained in medicine and technical sciences can document the accident at the site immediately after the event and are able with this information to reconstruct the accident very well.

The working method of in-depth investigation can differ between on scene, on scene in time and retrospective depending on the fact, when the team arrives on the scene of the accident. There are advantages and disadvantages of an investigation on scene in time, but such teams are able to collect traces parallel and independently of the police work. Only those teams are able to prepare true to scale drawings with all details by their own for the basis of a technical reconstruction and determination of collision speed. With such basis a reconstruction of vehicle movement can be started and the determination of collision and driving speed can be carried out in quality.

A second priority of the in-depth investigation approach is the assessment of motion trajectories of bodies inside and outside the vehicles. The known kinematics from dummy studies can be compared to the finding of impact points of the human body in real accidents pointing out the primary and secondary impact conditions. In-depth investigation should register the causes of injury related to different parts of the body. Injuries are the result of a mechanical load to the human

body that exceeds the load to the biological system. That biological system is divided into soft tissue, bony and ligamentary structures registered together with the injury severity based on AIS scaling. With the data of the technical survey, i.e. EES and Delta-v the border of injury load level can be pointed out. There are many other points describing the benefit of in-depth investigation approach.

Regarding the small radius of action of such in-depth investigation teams a very limited number of cases can be collected in a limited area of a country. Therefore a statistical sampling plan has to be defined for the approach of representative on one hand and a wide implementation of teams nationwide has to be implemented on the other hand. GIDAS (German In-Depth Accident Study) is one tool for describing in-depth investigation, there are others in the international in-depth investigation scenery. Meanwhile many teams were implemented round the world, i.e. NASS (National Accident Sampling System) and CIREN (Crash Injury Research and Engineering Network) in US, OTS (On the Spot Investigation) in UK working for the same task of detailed accident analysis, but working with different approaches and different methodologies. The demands for an exchange of data and experiences does exist, methods of data sampling and reconstruction procedures have to be concentrated internationally and a network of in-depth investigation centres has to be implemented in many countries worldwide.

References

- 1 VIANO, D., PARENTEAU, Ch.: Roll Crash Sensing and Safety Overview, SAE 2004-01-0342, Detroit USA, 2004
- 2 KRATZKE, S.: Light Vehicle Rollover, NHTSA Presentations to National Academy of Science (www.nhtsa.dot.gov/cars/problems/studies/NASRoll/), April 11-12, 2001
- 3 PARTYKA, S.: Roof Intrusion and Occupant Injury in Light Passenger Vehicle Tow-away Crashes, NHTSA, Febr. 1992
- 4 HIGHT, P. V., SIEGEL, A. W., NAHUM, A. M.: Injury Mechanisms in Rollover Collisions, 16th Stapp Car Crash Conf. SAE USA Nov. 1972
- 5 KOCHERSCHIEDT, H.: Verletzungskriterien bei Überschlagunfällen, Unfall- und Sicherheitsforschung Straßenverkehr 82, S. 135-140, 1991
- 6 MILTNER, E., WIEDEMANN, P.: Verletzungsmuster von Insassen bei Pkw-Überschlägen, Verkehrs-unfall- und Fahrzeugtechnik 10, 273-274, 1997
- 7 OTTE, D.: Unfälle im Bereich von Baustellen und an Schutzplanken, Vortrag Tagung Beton-Marketing Hannover 2004
- 8 OTTE, D.: The Accident Research Unit Hannover as Example for Importance and Benefit of Existing In-Depth Investigations, SAE-Paper No. 940712, Proc. International SAE Congress, Detroit/USA, 1994
- 9 OTTE, D., KRETTEK, C., BRUNNER, H., ZWIPP, H.: Scientific Approach and Methodology of a New In-Depth Investigation Study in Germany so-called GIDAS, ESV Conference, Japan, 2003
- 10 American Association for Automotive Medicine: The Abbreviated Injury Scale – Revision 98, American Ass. f. Automotive Medicine., Morton Grove, Illinois (USA), 1998
- 11 CDC, Collision Deformation Classification, SAE J224 MAR80, SAE Handbook, Society of Automotive Engineers, Warrendale, USA, 1985
- 12 OESTERN, H. J., TSCHERNE, H., STURM, J., NERLICH, M.: Klassifikation der Verletzungsschwere, Unfallchirurg, 88, 465-472, 1984
- 13 OTTE, D.: Injury Scaling: From Lesion Assessment to Passive Safety Improvement, Vortrag Round Table, Institute of Legal Medicine, University of Verona, Juni 1995
- 14 PARENTEAU, Ch., VIANO, D., SHAH, M.: Field Relevance of a Suite of Rollover Tests to Real-world Crashes and Injuries, Accident Analysis and Prevention Vol. 35: 103-110, 2003
- 15 BERG, A., BEHLING, R., HELBIG, M.: Rollover-Crashtests, ATZ 5/105, 3-10, 2003

H. Hautzinger, M. Pfeiffer, J. Schmidt
 Institut für angewandte Verkehrs- und
 Tourismusforschung e. V., Mannheim, Germany

Expansion of GIDAS Sample Data to the Regional Level: Statistical Methodology and Practical Experiences

1 Introduction

Data concerning accidents involving personal injury which have been collected in the context of in-depth investigations on scene in the Hannover area since 1973 and in the Dresden area since 1999 represent an important basis for empirical traffic safety research. At national and international level various analyses and comparisons are carried out on the basis of “in-depth data” from the above mentioned investigations. In-depth data play a decisive role e.g. within the validation of EuroNCAP results on secondary safety (crashworthiness) of individual passenger car models. Thus, statistically sound methods of data analysis and population parameter estimation are of high importance.

Since the 1st of August 1984 the “in-depth investigations on scene” in the Hannover area have been carried out according to a sampling plan developed by HAUTZINGER in the context of a research project on behalf of BAST. In the meantime a second region of in-depth investigation on scene was added with surveys in Dresden and the surrounding area. Internationally, the acronym GIDAS (German In-Depth Accident Study) is commonly used for the two above mentioned surveys.

The objective of a current research project (topic of this contribution) is, among other things, to examine and adjust the previous weighting and expansion method for the two regional accident investigations to the current general conditions.

2 The Project GIDAS: In-depth Investigation on Scene in the Hannover and Dresden Areas

2.1 Investigation Methodology

One of the main characteristics of in-depth accident investigations is that the research team

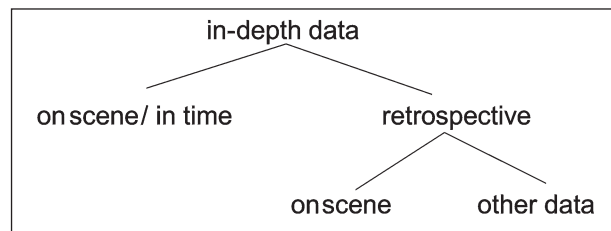

Fig. 1: Categorisation of in-depth data on road traffic accidents

arrives on scene and starts collecting the accident data immediately after having been alarmed by the police, rescue services, or fire department headquarters (“on scene” and “in time”). Apart from the acquisition of accident data on site (gathering information, taking pictures, etc.), the process of data collection also covers additional phases like the interrogation of witnesses or the collection of data at different places (e.g. hospitals, scrap yards). Basically, in-depth data can also be collected exclusively in retrospect by ex post examination of the spot of accident (“on scene”) or by gathering relevant data solely at other places.

Accident investigation in the Hannover and Dresden areas takes place daily during two six-hour time intervals (so-called shifts) following a 2-week cycle. During the first week data collection is carried out from 12:00 a.m. to 06:00 a.m. and from 12:00 p.m. to 06:00 p.m. and within the second week those accidents are documented that occur during the other two intervals (06:00 a.m. to 12:00 p.m. and 06:00 p.m. to 12:00 a.m.). Thus, the premise for the acquisition of accident data is that the accident occurs within the respective time interval and within the demarcated investigation area. In any case, however, only accidents involving personal injury are taken into consideration.

Within the shifts, the first reported accident involving personal injury is recorded by the team and subsequently all other accidents. Due to the fact that data acquisition on scene takes about one hour per accident, overlapping of accidents is possible. In this case, the most current accident after reestablishment of the operational readiness is registered.

2.2 GIDAS Survey Plan from a Sampling Theory Point of View

2.2.1 Target Population and Sample

From a sampling theoretical point of view the target population consists of all police-recorded accidents involving personal injuries which occur in

the Hannover and Dresden areas. Accidents which are reported neither to police nor to the rescue services do, strictly speaking, not belong to the target population, since they are not included in the official accident statistics and, therefore, cannot be considered in the expansion factor.

The sampling units (i.e. accidents) can be seen as “events” occurring in time and space. Therefore, at the beginning of the survey period there is no list containing all the elements of the target population which could serve as a sampling frame. This kind of target population can also be referred to as a “bulk of events”. Furthermore, neither the annual sample size nor the size of the target population are known in advance.

2.2.2 Selection of Time Clusters as Primary Units

The GIDAS sampling plan for the acquisition of accident data corresponds to a two-stage sampling procedure. The first stage is to randomly select time intervals as primary units (primary selection). With respect to the in-depth investigations, the primary units correspond to time clusters of accidents which are defined as follows:

For each calendar week exist – due to organisational reasons – the following two basic types of survey intervals (each of length $7 \times 12 = 84$ hours):

Type A: daily between 12:00 a.m. and 06:00 a.m. and between 12:00 p.m. and 06:00 p.m.

Type B: daily between 06:00 a.m. and 12:00 p.m. and between 06:00 p.m. and 12:00 a.m.

Consequently, based on one legal year, there exist 104 primary units.

Over the year, the time clusters according to the two basic types are being selected alternately, i.e. 52 out of 104 primary units are chosen. Thus, the selection of primary units can be regarded as a systematic sample with sampling interval 2. Due to this procedure all parts of the year are equally covered by the sample. For this reason – i.e. in view of the way the primary units are selected – systematic random sampling is superior to simple random sampling of time intervals.

Assuming perfect preconditions, that means that within each selected survey time interval (i) all police-recorded accidents are being reported

to the investigation team and (ii) all reported accidents are being registered by the investigation team, the GIDAS survey method corresponds to one stage systematic cluster sampling with sampling interval 2. These ideal preconditions are, however, not given in practice: on the one hand not all police-recorded accidents are being reported to the investigation team and on the other hand not every reported accident can be registered by the investigation team. Thus, a sampling procedure for the second stage, i.e. for selection of accidents within the selected time intervals (shifts) is needed.

2.2.3 Selection of Accidents as Secondary Units

With regard to the selection at the second stage, special emphasis has to be given to the documentation of as many accidents as possible. For this reason the first reported accident (involving personal injuries) of a selected time cluster has to be documented and after that all other reported accidents if the team is ready for operation. Due to the fact that the target population generates itself in the context of a randomised process, this selection method can also be referred to as random. The current alarming system, however, does not have an absolute random character in the sense that all survey units (accidents) have the same selection probability: by classifying the survey units according to accident severity (accident with slightly injured persons, with seriously injured persons, with persons killed) it becomes evident, that not all accidents have the same probability of being included in the sample, which essentially can be attributed to the alarming system. From a statistical point of view, inclusion in the sample depends on the results of two subsequent random experiments.

On the basis of a first random experiment it is determined whether or not a police-recorded accident is reported to the survey team. In case of an incoming report a second random experiment determines whether or not an accident will be registered by the team. The accident will be documented either if at the corresponding point in time the team is ready for operation or if the reported accident is the most recent reported accident after reestablishment of operational readiness of the team:

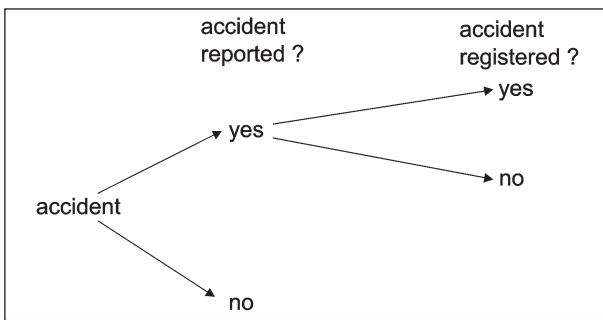

Figure 2

Presuming for a first analysis of the Hannover data from the year 2000, that the severity of accident consequences is the only determining factor for the reporting or non-reporting of an accident, the following estimates of the reporting probability are obtained:

- accident with slightly injured persons: 34.3%
- accident with seriously injured persons: 66.3%
- accident with persons killed: 75.0%

In contrast to accidents with slightly injured persons, accidents with persons killed or seriously injured are significantly more frequently reported to the investigation team. Certainly, a reporting rate of 100% would be ideal.

The following proportions show to which extent the reported accidents are actually documented:

- accident with slightly injured persons: 84.5%

- accident with seriously injured persons: 88.4%
- accident with persons killed: 96.3%.

The ideal case would be given if the documentation rates were identical. That means, even on the assumption of a perfectly working alarming system simple random sampling of secondary units (i.e. accidents on the second stage of the sampling procedure) can not be assumed on the basis of the empirical data from the year 2000.

All in all the following estimates for the selection probabilities can be obtained:

- accident with slightly injured persons: 29.0%
- accident with seriously injured persons: 58.6%
- accident with persons killed: 72.2%

While an accident with persons killed is selected with a probability of over 70%, the selection probability for an accident with slightly injured persons is only about 30%.

3 Weighting Procedure

The previous analyses of selection probabilities show that the raw GIDAS sample is biased at least with respect to severity of accidents. Therefore, a weighting procedure is needed in order to adjust or correct for this bias. The variables used for this fitting process should be those which correlate

Kind of accident	2000			2001		
	GIDAS unweighted	GIDAS weighted	official statistics	GIDAS unweighted	GIDAS weighted	official statistics
	accidents in %					
Collision with another vehicle which starts, stops or is stationary	5.3	5.9	9.8	6.6	6.8	9.4
Collision with another vehicle moving ahead or waiting	13.2	13.6	19.2	12.6	13.4	18.8
Collision with another vehicle moving laterally in the same direction	3.7	3.8	4.4	5.3	4.6	4.3
Collision with another oncoming vehicle	6.3	5.9	5.4	6.9	6.9	6.0
Collision with another vehicle which turns into or crosses a road	31.7	33.2	27.2	31.0	33.9	28.2
Collision between vehicle and pedestrian	12.6	11.7	9.5	10.8	10.6	9.4
Collision with an obstacle in the carriageway	0.2	0.2	0.4	1.0	0.8	0.5
Leaving the carriageway to the right	9.6	8.5	6.0	10.1	8.9	6.8
Leaving the carriageway to the left	7.1	6.6	4.8	7.3	5.7	4.7
Accident of another kind	10.3	10.4	13.4	8.4	8.5	12.0
Total	100	100	100	100	100	100
Chi ² goodness-of-fit	106.1	79.8	-	79.6	52.7	-

Tab. 1: Accidents involving personal injuries in the Hannover area by kind of accident (year 2000 and 2001)

highly with as many as possible other accident characteristics. At present, the GIDAS weighting procedure is based on three characteristics which cover factual and spatial as well as temporal aspects of accidents:

- severity of accident (accident with slightly injured persons, with seriously injured persons, with persons killed)
- locality of accident (within built-up area yes/no)
- time interval of accident occurrence (12:00 a.m. - 06:00 a.m./06:00 a.m. - 12:00 p.m./12:00 p.m. - 06:00 p.m./06:00 p.m. - 12:00 a.m.)

The weighting procedure consists of a simple adjustment of the above three-dimensional contingency table to the corresponding table from official accident statistics of the respective survey area.

Although a three-dimensional distribution is used for weighting, it was found that the accuracy of some of the estimates is not satisfactory. As an example, in table 1 the weighted and unweighted GIDAS estimates for the Hanover area are compared to the official statistics with respect to the variable “kind of accident”.

The table shows that in each of the two years under investigation the weighted distribution is very similar to the unweighted one, although the fit of the weighted distribution to the official statistics is slightly better. Nevertheless, the effect of the weighting procedure is relatively small. The two distributions of “kind of accident” obtained from GIDAS data, however, differ considerably from the official accident data. In all cases the null hypothesis of equality of GIDAS and official distribution can be rejected since the empirical χ^2 -values are far beyond the critical value of 16,9 (level of significance: 5%).

Due to this results and the above mentioned bias with respect to accident severity it was decided to develop and test an alternative weighting procedure based on the following two variables:

- severity of accident (accident with slightly injured persons, with seriously injured persons, with persons killed) and
- kind of accident (10 categories).

It was assumed that locality of accident is strongly correlated to accident severity and, therefore, using one of them in the weighting procedure might be sufficient. Moreover, it was hoped that considering the variable “kind of accident” in the

Locality of accident	2000			2001		
	GIDAS unweighted	GIDAS weighted	official statistics	GIDAS unweighted	GIDAS weighted	official statistics
	accidents in %					
Within built-up area	72.8	75.5	75.7	69.7	73.2	75.8
Outside built-up area	27.2	24.5	24.3	30.3	26.8	24.2
Total	100	100	100	100	100	100
Chi ² goodness-of-fit ¹	4.8	0.02	-	19.0	3.3	-

¹ critical value 3.84 (level of significance: 5%)

Tab. 2: Accidents involving personal injuries in the Hannover area by locality of accident (year 2000 and 2001)

Time interval	2000			2001		
	GIDAS unweighted	GIDAS weighted	official statistics	GIDAS unweighted	GIDAS weighted	official statistics
	accidents in %					
12:00 a.m. - 06:00 a.m.	3.3	2.8	6.1	4.1	3.3	5.0
06:00 a.m. - 12:00 p.m.	34.6	35.1	29.0	28.9	29.5	29.4
12:00 p.m. - 06:00 p.m.	40.4	41.1	43.8	41.1	42.4	43.5
06:00 p.m. - 12:00 a.m.	21.6	21.0	21.1	26.0	24.8	22.1
Total	100	100	100	100	100	100
Chi ² goodness-of-fit ¹	27.6	33.7	-	9.4	8.0	-

¹ critical value 7.81 (level of significance: 5%)

Tab. 3: Accidents involving personal injuries in the Hannover area by time interval of accident (year 2000 and 2001)

Light conditions	2000			2001		
	GIDAS unweighted	GIDAS weighted	official statistics	GIDAS unweighted	GIDAS weighted	official statistics
	accidents in %					
daylight	74.1	75.3	73.3	72.5	72.7	73.8
dawn	3.9	3.4	4.6	4.6	5.3	5.0
darkness	22.0	21.2	22.2	22.9	22.0	21.2
Total	100	100	100	100	100	100
Chi ² goodness-of-fit ¹	1.2	3.9	-	1.7	0.6	-

¹ critical value 5.99 (level of significance: 5%)

Tab. 4: Accidents involving personal injuries in the Hannover area by light conditions (year 2000 and 2001)

Kind of accident site	2000			2001		
	GIDAS unweighted	GIDAS weighted	official statistics	GIDAS unweighted	GIDAS weighted	official statistics
	accidents in %					
not stated	79.1	79.4	79.1	77.3	77.8	78.3
road crossing	7.0	7.3	6.9	7.2	7.3	6.8
junction	7.8	7.8	8.2	7.6	7.9	8.3
property gateway	2.1	2.1	2.2	2.3	2.3	2.5
gradient	0.8	0.7	0.9	1.3	1.2	1.1
curve	3.2	2.7	2.7	4.3	3.5	2.9
Total	100	100	100	100	100	100
Chi ² goodness-of-fit ¹	4.1	2.1	-	22.4	5.2	-

¹ critical value 11.1 (level of significance: 5%)

Tab. 5: Accidents involving personal injuries in the Hannover area by kind of accident site (year 2000 and 2001)

weighting process will compensate possible biases with regard to the temporal distribution of accidents. In tables 2 to 5 it is shown whether these expectations proved true for the GIDAS 2000 and 2001 data. Variables to be analysed are:

- locality of accident
- time interval
- light conditions and
- kind of the accident site.

Concerning locality of accidents, the new weighting procedure (by severity and kind of accident) is substantially improving the fit of the distribution. In both years the null hypothesis can be rejected for the unweighted data whereas a good representation of the target population can be obtained by using the weighted distributions. This is due to the fact that locality is closely linked to accident severity since the probability for a severe accident is lower within built-up areas.

Regarding the variable “time interval of accident”, the new weighting scheme yields no correction of

the bias. In 2000, the fit is worse than in 2001. This is mainly caused by the failure of the alarming system. Especially in the stratum 12:00 a.m. – 06:00 a.m. where only a few accidents are occurring anyway, the reporting rate is lower than in the other strata.

In table 4 and 5 the results for the accident characteristics “light conditions” and “kind of accident site” are depicted. Concerning light conditions, the fit of both the weighted and unweighted sample distributions can be regarded as good. One can see that there is a slight coherence between light conditions and time interval since for both cases the fit of the weighted distribution is better in 2001 whereas the opposite is true in 2000.

Finally, the weighted distributions of the variable “kind of accident site” are again closer to the official statistics than the unweighted ones. This holds particularly for the 2001 data where the null hypothesis of equality can be rejected for the unweighted distribution but not for the weighted one.

4 Concluding Remarks

The results described above may be summarised as follows:

- The figures presented in tables 2 - 5 show that appropriate expansion and weighting procedures can substantially improve the accuracy of the data from in-depth accident investigations. Of course, the main objective of expanding in-depth data to the target population is to expand variables which are not included in the official accident statistics (e.g. AIS, EES, etc.). In the present paper variables which are contained both in the sample and in the official statistics have been analysed in order to check the goodness-of-fit of the weighted sample distributions.
- Usually, accident characteristics which are recorded by police are also collected by the in-depth investigation team. However, it might well be that these two different measurements do not yield the same results, e.g. if police assigns an accident to another kind of accident than the research team does. It is important to note that in any case the police recorded data (standard traffic accident reports) of the accidents in the sample have to be used for expansion purposes. Even if the data from the in-depth investigation team are more precise it would be incorrect to base the weighting factors on them because in this case some of the accidents in the sample would be assigned to the wrong stratum (according to the target population).
- As described above, the in-depth investigations in the Hannover and Dresden areas are based on a two-stage sampling process. Therefore, according to the principles of sampling theory it would be most natural to use a two-stage expansion methodology. That is to say, in a first step the secondary units (accidents) would be expanded to the primary units (parts of calendar weeks) and after that the expansion of the primary units would take place. Within the scope of the research project on which the present contribution is based such a methodology has been carefully developed and tested. It was found, however, that the theoretical advantages of this method compared to the simple weighting procedure described above are relatively small, especially, if one takes into account the complexity of the

calculation process necessary to obtain the corresponding expansion factors.

M. C. Simon
Centre d'Etudes Européennes et d'Analyse des
Risques CEESAR, France

T. Hermitte
CEESAR Nanterre, France

P. White
International Road Transport Union (IRU) Genève ,
Switzerland

A Common Methodology for Truck Accident In-depth Study

Abstract

Road safety is a major preoccupation of the European Commission and the road transport industry and depends on numerous significant factors.

In order to improve road safety and to plan effective safety improvement actions for truck transport, we must first identify the problems to be addressed, i.e. what are the main causes of truck accidents.

The ETAC project, initiated by the European Commission and the IRU, was launched in order to set up a heavy goods vehicle accident causation study across European countries to identify future actions which could contribute to the improvement of road safety.

The results will be based on a detailed analysis of truck accident data collected in seven European countries according to a common methodology which has been elaborated through numerous national and European projects.

This paper describes the common methodology used to collect the information on the scene of the accident and to analyse the data so that the reconstruction of the crash events may be carried out. CEESAR proposes a methodology using its experience gained from over 10 years of accident data collection. This methodology is based on an in-depth investigation of the parameters involved in an accident and linked to the driver, the vehicle, the road and their environment. In-depth investigation requires accident investigator presence on the scene of the accident in order to collect volatile information such as marks on the road, weather conditions, visibility, state and equipment of the vehicle, driver interview. Later, passive and active information is gathered, either at the hospital for the

driver, at the garage for the vehicle or on the spot for the road geometry. A reconstruction carried out with the help of specific software and the analysis of the data collected and calculated enables the identification of the main causes of the accident and the future actions to plan in order to improve road safety as regards truck traffic.

Introduction

Road safety is a major preoccupation of the European Commission and the road transport industry, and depends on numerous significant factors. Many projects and research initiatives have been launched (or will be launched) by the EC to reduce the number of road accidents. Although the overall aim is always the same, the specific objectives of these projects are different: some of the road safety problems can best be tackled by vehicle manufacturers by the improvement of passive or active safety (projects such as EACS, MAIDS, ECBOS), others by infrastructure (RISER), others again by European regulations, driver training, etc. Despite the common goal of improving road safety, each study is specific and it is often very difficult to find common elements to link or combine different studies.

I – General overview of the ETAC Survey

I – 1 The Survey

This project was initiated by the IRU (International Road Transport Union) and the EC (European Commission).

IRU invited CEESAR to coordinate activities and to set up a commercial vehicle database, based on previous experience in accidentology and participation in several important European road safety projects.

This means:

- selecting the truck accident investigation teams who will participate,
- developing the empty database,
- providing the questionnaire and guide for use by the truck accident investigation teams,
- ensuring that the quality of all aspects of the survey, especially of the data entered into the database by the truck accident investigation teams, meets the quality criteria defined.

I – 2 CEESAR's Activities

CEESAR is a non-profit association created in 1993 to undertake research and studies into road accidentology and biomechanics.

CEESAR's aims:

- Knowledge exchange, sharing of experience and savoir-faire to improve safety, primarily road safety.
- Research and experimentation for accident risk and injury reduction.
- Biomechanical research for the study and analysis of human body and dummy movement during crashes.
- Training methods for socio-economical specialists in accidentology.
- Driver and road user training programmes.

CEESAR's different activities are:

- DESA Accidentology and Epidemiology Department "In-depth accident investigation"

ACTIONS: conduct accidentology research programmes, collect accident data, elaborate statistical and epidemiological studies from this data.

- DPEB Experimental Pathology and Biomechanics Department "Study of occupant movements resulting from a car crash"

ACTIONS: evaluate human traumatological tolerances, implement numerical modeling and develop the expertise necessary to ensure dummy biofidelity.

- DESC Experimentation and Behavioral Science Department "Study of vehicle related movements"

ACTIONS: analyze human behavior based upon physiology, postural and cognitive ergonomics and human movement science.

I – 3 IRU's Activities

The IRU, through its national associations, represents the entire road transport industry worldwide. It speaks for the operators of coaches, taxis and trucks, from large transport fleets to driver-owners. In all international bodies that make decisions affecting road transport, the IRU acts as the industry's advocate. By working for the highest

professional standards, the IRU improves the safety record and environmental performance of road transport and ensures the mobility of people and goods. Among its practical services to the industry, the IRU is international guarantor of the TIR carnet system under which trucks are sealed by customs upon departure and can cross several borders without further checks until they reach their destinations.

The IRU:

Takes the initiative in making sure that vehicles are safe, clean, efficient, and economical in fuel consumption,

- encourages sound fleet management, strict vehicle maintenance and good working conditions for drivers; - helps to make roads safer and less congested,
- seeks improvements in the environmental performance of vehicles,
- maintains close working relationships with the competent national, inter-governmental and non-governmental organisations,
- works for harmonisation and simplification of procedures affecting road transport,
- alerts the industry to changes in national and international legislation,
- strives to lift the barriers to international transport and trade.

I – 4 The Project and its Objectives: Identify the Main Causes of Truck Accidents

This project, initiated by the European Commission and the IRU, was launched in order to set up a heavy goods vehicle accident causation study to identify future actions which could contribute to the improvement of road safety.

If we want to improve road safety and to plan effective safety improvement actions for transport by trucks, we must first identify the problems to be addressed, i.e. what are the main causes of truck accidents.

The ETAC database will enable the:

- identification of the main causes of accidents involving trucks;
- reconstruction of the pre-collision phases;
- identification of critical situations;

- analysis of malfunctions;
- definition of scenarios of accident types;
- study of the information needed by drivers in the “pre-collision” phase;
- a priori quantification of the potential interest of certain driver aids.

II Teams

II – 1 Teams

Institutes in seven European countries are participating in this project (figure 1).



Fig. 1: Team geographical distribution

II – 2 Team Requirements

Teams must:

- investigate accidents on site and in real time,
- control the sampling. Each team shall report its national accidents statistics and its local Statistics in relation to their survey area for the period of the survey. They are to be compared to the sampled accidents in order to establish the representativeness of the sample,
- collect as much objective and descriptive data as possible (on scene, by interviews or physical examination) according to the team's experience and the methodology agreed by IRU and CEESAR for the ETAC project,
- as far as possible, interview all people involved (drivers, passengers) and if possible the policemen, eye witnesses, doctors...,
- use the common questionnaire supplied with the common manual as a guideline to accident investigation,
- study the vehicle and the accident scene using the team's experience and the ETAC methodology,
- collect medical information directly from hospitals in order to be able to encode the injuries according to the AIS code,
- carry out encoding according to the instructions contained in the manual,
- take as many relevant photos as possible,
- include the best photos in the ETAC database,
- draw an accident site map and prepare the reconstruction according to the ETAC methodology,
- write a short narrative of the accident,
- respect team safety requirements as regards: safety during the journey to and from the crash site (compliance with speed limits and all relevant traffic rules), safety on the site of the accident (regulatory and phosphorescent clothing).

III Accident Investigation Method and Accident Selection

III – 1 General Requirements

- A minimum of 600 truck accident cases occurring between 1 April 2004 and 31 March 2006 must be investigated.
- All truck accidents will be investigated using the same methodology.
- Truck accidents will be collected from a sample area considered to be as representative as possible of the national truck accident situation.
- All accident cases will be investigated on the spot as soon as possible after the accident (in real time if possible) by a team composed of accidentology and data collection experts.
- Each accident studied must involve at least one truck (commercial vehicle of gross weight >3.5t).
- Accidents may involve a single truck (rollover, against a fixed obstacle...)
 - or a truck and another vehicle (truck, car, 2-wheelers).
 - or a truck and a pedestrian.
- All accidents must involve at least one injured person.
- The accident should be studied in depth, covering both passive and active safety. Accident cases must be well documented. It is important to keep only accidents for which teams have a high level of information. Because the aim of this project is to understand accident causes, only cases where the causation is available will be retained.

III – 2 Data Quality

III – 2-1 On the Spot

It has been proven that the best way to understand the causation process is to go to the scene of the accident as soon as the accident occurs. Deferred investigations (several hours or even days after the accident) prevent the analysts from getting useful information such as participant interviews, witnesses, evidence, road state, and vehicle marks on the road, traffic conditions and so on. It is true that some of the information can be found in police

reports but experience has shown that police reports do not provide in-depth information. Policemen are not professional safety researchers.

Therefore, when using data taken from police reports, teams must be confident that they provide the quality and objectivity needed for the ETAC study.

III – 2-2 Accident Investigators

Each team must collect the information directly on scene and later on at the hospital, garage. They should use the police report as little as possible. If they are called by the police and reach the accident scene after the driver has left or the vehicles have been moved and the crash or final positions of the

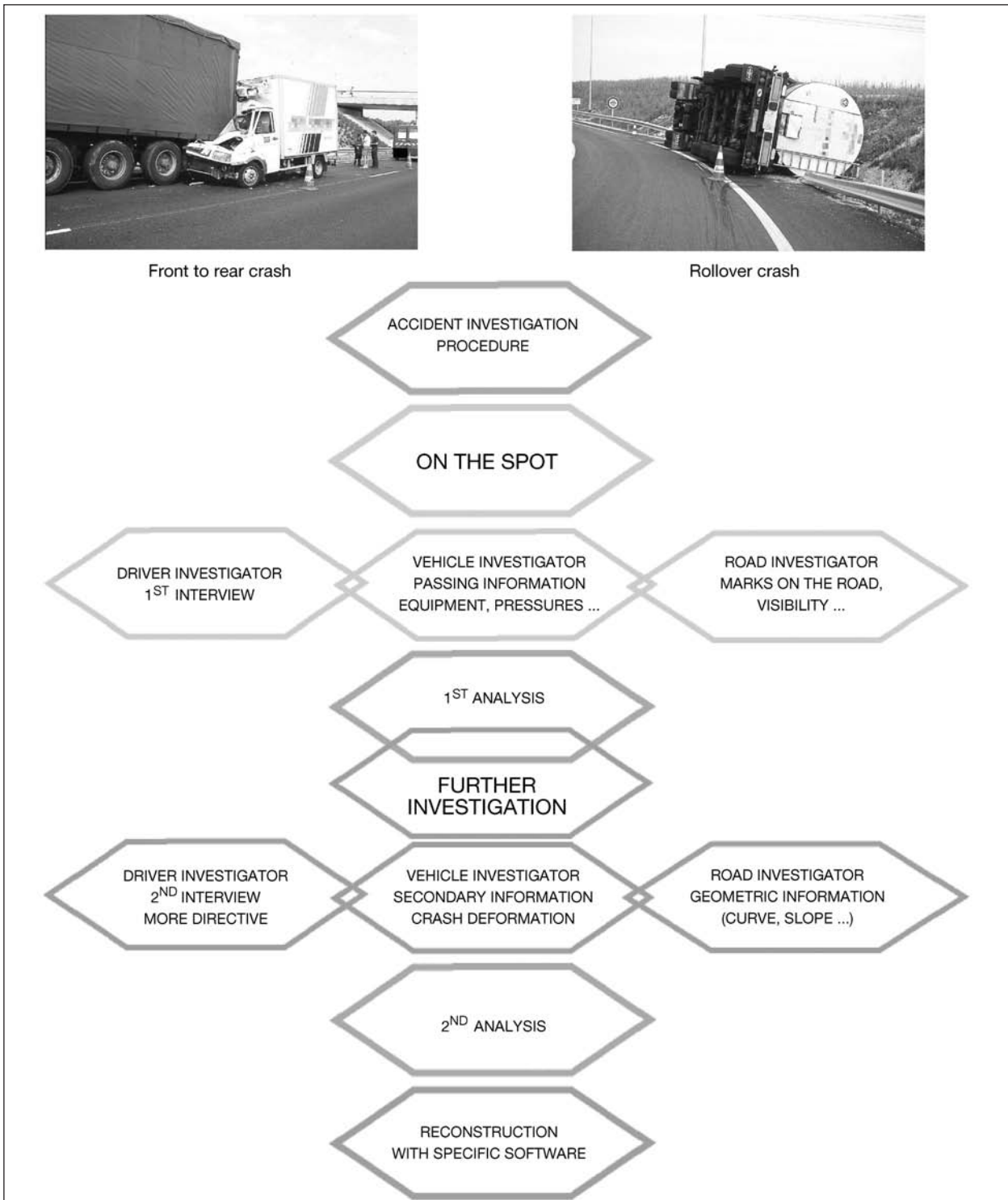

Figure 2

vehicles or other participants in the accident cannot be determined, the accident must not be investigated. The objective is to obtain as much information as possible to enable cognitive and cinematic reconstruction of the accident.

After the collection of the information on site, complementary information is collected at the hospital (especially second interview of the person involved and collection of the injury form), at the garage to collect crush deformations or at the local transport authority for further details about the traffic or road configurations.

III – 2-3 Accident Coding

Most of the information can be coded and entered into the database according to the instructions in the Manual. The coding is the essential link to be able to draw conclusions as to the main causes of accidents which is the aim of the study. Information that cannot be coded is conserved in original files along with photos, sketches and video movies if necessary and can be indicated in the window reserved for the accident summary or in the textual fields provided in the database.

III – 2-4 Methodology Assessment

This accident investigation methodology has several benefits. It is the best way to understand the accident because teams arrive at the same time as the police and the rescue services and collect as much information as possible on the spot. They have in-depth knowledge of each accident and its causation.

III - 3 Accident investigation procedure

III - 3-1 General Outline (figure 2)

III - 3 2 On the Spot of the Accident

Driver investigator role

When possible, the “driver investigator” interviews drivers on the scene of the accident, about the pre-crash, crash and post-crash situations. They discuss the conflict situation, the driver’s perception of it and his evasive actions. The driver thus benefits from visual references on the accident scene and his account of the accident scenario is richer. If the driver is injured and needs immediate medical treatment, the length of the first interview depends on his state. The investigator collects as much information as possible on the

scene of the accident from passengers and witnesses and then heads to the emergency ward of the hospital.

The first interview takes place just before or after initial medical treatment on the spot, unless the driver is unconscious or undergoing emergency surgery. In that case the interview takes place as soon as possible after medical treatment at the hospital.

The interview is recorded if possible in order to corroborate the other information and to complete the phase definitions throughout the reconstruction.

Road Investigator Role

The “road investigator” marks the final position of the vehicles, identifies and measures all the marks that vehicles leave before, during and after the crash (point of crash, braking, sliding, driving and scratching marks). He then takes photos of the accident scene from a road infrastructure point of view (final position, skid marks, road geometry, road surface, weather conditions...). Once all this volatile information has been photographed, he draws up a sketch of the accident scene which includes the approach path of each vehicle, the marks, their final positions, the road and roadside geometry and road signs...

Vehicle Investigator Role

The “vehicle investigator” photographs the vehicles in their final position, the deformations, the state and use of vehicle equipment, load, etc. Once this is done, he examines the use and the state of the various equipment (lighting, radio/telephone,



Fig. 3: Driver interview recorder



Fig. 4: Vehicle marks on the road and rest position of the vehicle



Fig. 7: Driving marks on the roadside



Fig. 5: Sliding marks



Fig. 8: Vehicle investigation



Fig. 6: Scratching marks, point of impact

seat position and belt use, gear level position, tyre pressure, etc.) in detail. He also talks to the emergency services about their extraction methods and any other changes that they might have made to the vehicle.

III - 3-3 Further Investigation

The “driver investigator” meets the driver once again, at hospital or at home, to discuss personal and medical details, general driving habits, training, previous accidents and sanctions, before coming back to the accident situation. The information collected from the other driver and the other accident investigators is used to corroborate or to contradict the driver’s initial declarations.

The “road investigator” collects complementary information about the road geometry, pavement friction and traffic conditions (density, speed, etc.). He uses this information to complete his accident sketch and then draws up a scale plan of the accident scene.

The “vehicle investigator” returns to see the vehicle and carries out a more in-depth study of the vehicle, engine, braking, steering systems, other equipment and its condition. He also measures vehicle deformation and looks for impact zones



Fig. 9: International vehicle deformation measurement



Fig. 10: Crush deformation



Fig. 11: Crush deformation

inside and outside the vehicle, which may correspond to injuries sustained by the participants or a pedestrian or the impact of another vehicle.

III - 3-4 Accident Analysis (Primary and Secondary Safety Point of View)

Experts encode the information about the crash: vertical and horizontal overlap of the crash,



Fig. 12: Crash vertical overlap

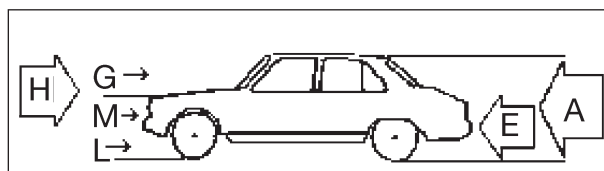

Fig. 13: Crash vertical overlap

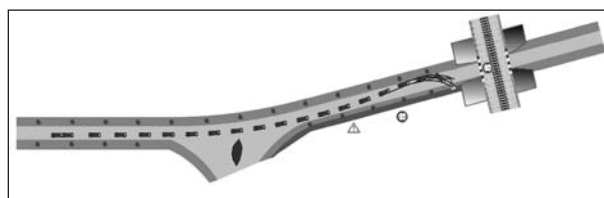

Fig. 14: PC-Crash 2D simulation

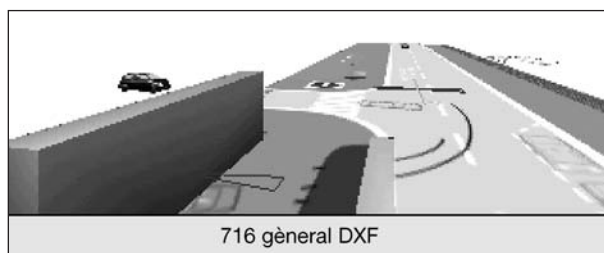

Fig. 15: PC-Crash 3D simulation

crushed surfaces, depth of the crash deformations...

They evaluate the energy dissipated through vehicle deformations (so-called Equivalent Energy Speed) with the support of a crash test library, previous reconstruction and experience.

The information collected by the three investigators is then used as the basis for a dynamic reconstruction using PC-Crash software¹. The conservation of energy equations is used to give initial dynamic parameters. The scale 3D map serves as the background for a reconstruction which starts at the rest position of the vehicles and goes back in time through the post crash, the crash and the pre-crash phases. Each phase is based on the information collected by the investigators.

¹ Dr. Steffan Datentechnik, Linz, Austria

The accident is analysed according to a sequential model based on:

- Accident type(s) (loss of control/intersection crash/rollover...)
- Failure type(s)
- Failure function(s)
- Failure mechanism(s)
- Sequence of events (driving/conflict/emergency/crash/postcrash)

The results of these cinematic and cognitive reconstructions are used to determinate the main causes and contributing factors and allow active safety improvements throughout regulation, active safety countermeasures (determination, evaluation), driver formation, and road improvements.

From a passive safety point of view, the participant's medical report, which is supplied by the local hospital, is used to correlate the injuries sustained with the accident injury mechanisms and the zones impacted inside or outside the vehicle. This correlation is the basis of passive safety improvements through passive safety equipments.

IV – Database: Data Coding and Data Manual

IV - 1 Database Content

A common database is created to record all accident cases. Data is collected and encoded according to the common questionnaire. The same data codification is used by all the investigation teams according to a common manual.

In order to be able to carry out accident research, additional information is required. We have added a multi-media database which provides:

- Digital photos of

- o vehicles: photos around vehicle, the inside of the vehicle, specific information or vehicle defects,
- o roads: the surface and its state, the friction problems (if pertinent), visibility problems, road markings, the point of impact, skid marks, sliding marks, scratching marks...
- o the conditions of the journey just before the crash: photos of the immediate surroundings of the approach route (visibility, geometry of the road)...

- Sketches (JPEG format) of the accident scene drawn with specialised software.

We require 2 types of sketch:

- o 1st sketch: an accurate drawing with the rest positions of the involved vehicles, the marks on the road surface (skid marks, scratching marks, sliding marks, point of impact...). Visibility problems, road friction coefficients, road and shoulder profiles (described in the database presentation) should figure on the sketch, as well as everything that can help to understand the accident. An indication of the scale is necessary. For instance see figure 17.



Fig. 16: The curve before the crash

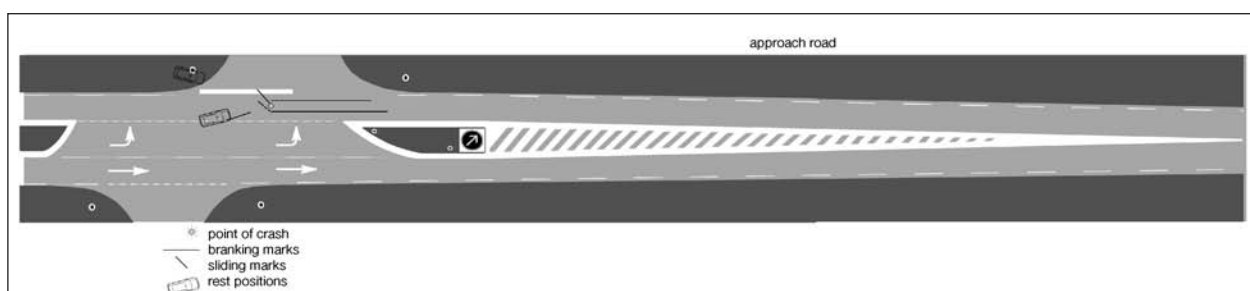

Fig. 17: Sketch of the accident

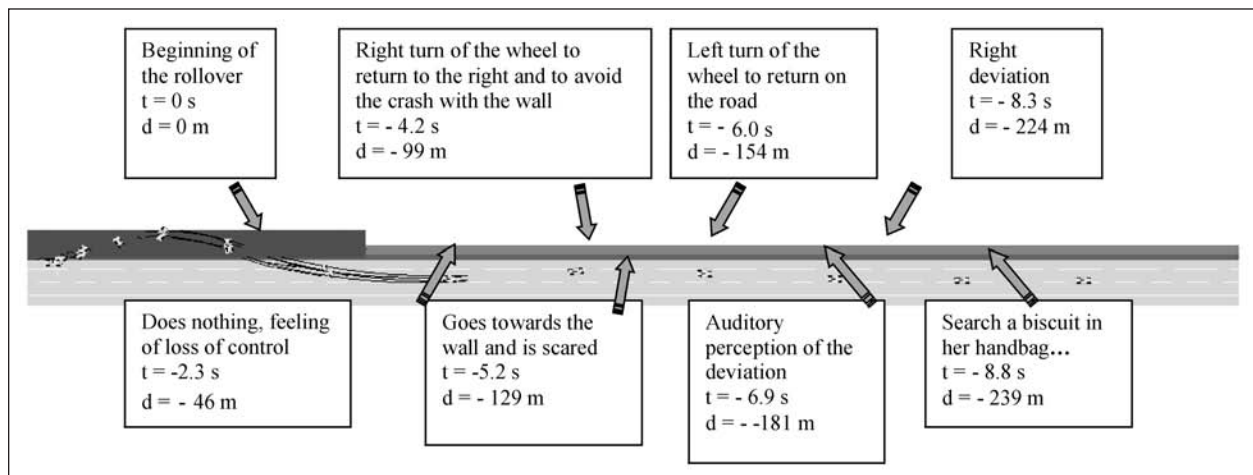

Figure 18

For instance:

- o 2nd sketch: in relation to the reconstruction and the pre-crash table (further detailed in the database presentation), a sketch with the relative position of the vehicles linked to their time to crash and their distance to crash see figure 18.
- o And a summary of the accident in which the investigators relate the accident and add qualitative complements to the coded information. Because the analysis is performed on the basis of the database, we need both comprehensive and summary information. We especially require accurate information without subjective judgements. This means facts and expert analysis.

IV - 2 ETAC Database Contents

The final multimedia database contains:

- Conclusions: main accident causes
- Data: entered using a common software package provided by CEESAR (questionnaire and manual provided),
- Sketches: plan with final position, tyre marks (or others) before and after the crash, the point of impact, the curb measurement, the road level, etc.
- Summary: general circumstances, comments, etc.
- Digital photos: of the vehicles, the accident site, the marks, the road

IV – 2-1 ETAC Questionnaire Contents

CEESAR provides a questionnaire which takes into account each aspect of the accident. This questionnaire allows the identification of the principal and subsidiary causes of the truck accident.

The questionnaire form is based on CEESAR's (Centre Européen d'Études de Sécurité et d'Analyse des Risques), INRETS's (Institut National de Recherche sur les Transports et leur Sécurité) [1], TNO's and NHTSA's (National Highway Traffic Safety Administration) experiences and on EACS (European Accident Causation Survey) [2], MAIDS (Motorcycle Accident In-Depth Study), RISER (Roadside Infrastructure for Safer European Roads) databases.

The questionnaire oriented to truck accident causation is divided into 6 different parts:

- General information
 - Identification
 - Vehicles, objects, pedestrian involved
 - Location
 - Weather conditions
 - Light conditions
 - Common infrastructure equipment
 - Accident type
 - Accident severity
 - Summary and comments
 - Photos
- Road and environment information for each vehicle
 - Identification
 - Road type

- Road restrictions
 - Road geometry
 - Horizontal and vertical signalisation
 - Junctions/round about
 - Curves/straight lines
 - Road edges
 - Road surface
 - Road equipment
 - Traffic
 - Breaks in the infrastructure
 - Geometrical visibility and limits
 - Detailed scale sketch
- Vehicle information for each vehicle including the trailer
 - The whole vehicle
 - Identification
 - Accident severity
 - General information
 - Visibility of the vehicle (colour and contrast)
 - Motor vehicle except 2 wheelers: Common information (car, bus and trucks)
 - Identification
 - General administrative and technical information (manufacturer, model, VIN (Vehicle Identification Number) year of 1st registration, type of profile, colour and contrast, general weight and power information...)
 - Design or geometric specifications (length, width, overhang, height from the ground of the vehicle, ...)
 - Tyres, wheels and suspension
 - Technical design (gear box, engine position, type of brake, tank position, lights...)
 - Equipment (visibility: mirrors, driving aids: ABS, ESP, cruise control..., and the use and state of the secondary safety equipment: seat belt (fixed in the vehicle and used), airbag, pretensioner, and underrun protection..., comfort: radio, television, fridge...)
 - Vehicle general technical state before the crash
 - Load during trip and load securement
 - Vehicle defects before the crash (general, steering, braking, suspensions, lights, mechanical failures...)
 - State at the time of the accident (use of the radio or CD player or phone..., use of lights or position of sun visor...)
 - Reading of the speed recorder or tachograph (speed before the braking, speed before the crash, respect of rest pauses, respect of speed limits, time after the last pause...)
 - Accident collision recorder
- The trailer
 - Identification
 - General technical information
 - Design specification
 - Vehicle parameters
 - Load during the trip (nature, position, fixed, danger, aspect, form...)
 - Tyres and wheels
 - Rear underrun protection
 - 2 wheelers
 - Identification
 - General information
 - Specific bicycle/motorcycle information
- Road user information
 - For the driver and each participant
 - Identification
 - Personal status
 - Vehicle occupant report/secondary safety
 - Child restraint data
 - Two wheeler occupant data
 - Injury report (MAIS Main Abbreviated Injury Scale, AIS 90)
 - For the driver only
 - Identification
 - Personal status
 - Long and short-term illness
 - State of the driver or rider
 - Driving license for this vehicle (available or not, training, date...)
 - Driving experience with this sort of vehicle
 - Vehicle and equipment knowledge
 - Intoxication level
 - Trip in progress (type, purpose, destination, the choice of the itinerary, the start of the trip, the frequency...)
 - Previous infractions
 - Previous accidents
 - Accident and emergency situations (perception, understanding, actions...)
 - Blind spot
 - For the pedestrian
 - Identification
 - Personal status
 - Health, long and short-term illness

- Intoxication level
 - Trip in progress
 - Accident and emergency situations
 - Injury report (MAIS Main Abbreviated Injury Scale, AIS 98)
- Reconstruction information for each vehicle
 - Aspects recorded on the site of accident (volatile information, equipment, tire pressures, skid marks, visibility...)
 - Impacts and the vehicle (crash deformations, overlap, EES (Equivalent Energy Speed), a crash library will be available if necessary, TDC (Truck Deformation Code) ...
 - Fire
 - Pre-crash phases (phases described before the collision or the beginning of rollover...)
 - Pre-collision table (each phase is described with the time to crash, the speed, the deceleration, the distance, the driver's action...)
 - Analysis
 - Accident causation (accident analysis – main accident causes)
 - Accident avoidance systems

IV – 2-2 ETAC Manual

CEESAR has written a data coding protocol, explaining each item to ensure coherent coding by the different data collection teams. As a complement to this guide, the project is also interspersed with seminars to exchange experiences, questions and to ensure the common encoding manner and understanding.

The manual is integrated in the software and is thus available as soon as the coding task needs it. A paper manual is also provided.

IV – 2-3 ETAC Software

CEESAR has provided an electronic data template programme to ensure that the accident data coding form is the same for each investigation team. The software allows data quality control in each table and between tables. The variables may be encoded either directly or with a drop down list. All “other” responses require explanation in a textual field in order to complete the data.

Each team must then use the integrated quality control process included in the software before delivery.

IV – 2-4 ETAC Quality Control

In order to monitor the quality of the database throughout the survey, CEESAR will undertake rigorous quality inspection presented below.

At the beginning of the project, a data collection schedule was agreed in order to ensure that objectives would be reached in due time.

In order to assist in the quality control process, each team must check its data before sending it to CEESAR. As explained above, the software helps to identify incoherent information, missing values and mistakes.

Conclusion

The accident investigation methodology has been tested and improved by CEESAR teams over 10 years of data collection. European experience has also been used to develop the common database. All this experience enables us to take into account European preoccupations and different goals.

One such European preoccupation is the understanding of truck accident causes. So, even though common databases exist for car (EACS) and 2 wheeler accidents (MAIDS), a common truck accident database is a new target. The success of such a common database depends upon the strict respect of the commonly accepted methodology.

The methodology takes into account all aspects of the accident, following a sequential study, including the reconstruction and the analysis of the data which are both essential and additional expertise in the identification of accident causes.

Developing a common truck accident database is an additional step towards a common database for all vehicle types. It is very important to improve the contents and the quality of the collected data. This quality target will allow European road safety improvements throughout the understanding of the different travelling and risk exposures of the different countries.

References

- [1] F. FERRANDEZ: L'étude détaillée d'accidents orientée vers la sécurité primaire: méthodologie de recueil et de pré-analyse, Presses de l'École Nationale des Ponts et Chaussées, 1995
- [2] B. CHENISBEST et al: - European Causation Survey (EACS) methodology, ESV 16th, Windsor, Ontario, Canada, 1998

F. Alonzo, M. Nguyen, J. P. Verriest
INRETS, Biomechanics and Human Modelling
Laboratory, Bron, France

A New Methods for the Evaluation of the Quality of Accident Reconstructions

Abstract

In order to improve the protection of children transported in cars, within the CHILD programme (GR3D-CT2002-00791) real world road accidents are thoroughly analysed and then reconstructed in laboratory.

Prior to comparing injury severities of real victims to physical parameter values measured on the dummies, the quality of the reconstructions is evaluated by experts who use their experience based on the investigation of numerous and various accidents.

This paper presents a new tool aiming at better evaluating and validating accident reconstructions. It is based on statistical evaluation of vehicle deformations which gives weighing factors for every part of the car body structure finally leading to a specific Reconstruction Quality Score (RQS indicator). Furthermore, the reliability of this score, depending on the number of measured points, can be established.

This tool includes a function aiming at adjusting the speed for a further reconstruction and at defining the launching speed and the pulse shape for complementary sled tests.

Finally, the functions of the RQS software and database are presented.

Introduction

Biomechanical knowledge for passive safety purpose is currently based on experimentations performed with PMHS's. The advantages, legal conditions and scientific limitations of this method are well known. The main experimental parameter reducing the application of test results for the protection of human life is the mean age of the subjects.

An alternative to experiments performed with anatomical body parts is represented by real-life accident investigations supplemented by their experimental reconstructions. The main advantage of this research way is that the panel of victims is representative of the whole population exposed to the risk of collision.

Moreover, for such specific occupants like children, for whom it is very difficult or even impossible to perform PMHS testing, it is the only way for acquiring reliable biomechanical data.

In both methodologies, the ultimate goals are identical. These are:

- a identification and description of injury mechanisms;
- b definition of relevant injury criteria;
- c determination of reliable injury risk curves and protection reference values for the crash anthropomorphic dummies used for regulation purpose or comparative crash tests performed for consumers information.

The advantages of the accident investigation/reconstruction method are however balanced by some difficulties which may lead to unreliable results. These difficulties are mainly due to the fact that accident analyses are carried out a posteriori. Hence, equivalent energy speed (EES), overlap, angulations and body vehicle heights are assessed by experts and partly based on empirical methods. Moreover, particularly in the case of injured children using CRS's, parameters such as adjustment of belt or harness and especially misuses are difficult to determine. Consequently, it seems necessary to develop methods aiming at eliminating those approximations leading to weak correlations. It is the case of accident speed, overlap and angulations which have an effect on the car(s) deformations and consequently on the loads sustained by the occupants. Over the years, a lot of effort has been devoted to increase the accuracy of the evaluation of these accident parameters from accident scene evidences (see for instance McHENRY et al., 2003, or MOSER et al., 2003). But in the evaluation of the quality of the reconstruction, the deformation sustained by the vehicle(s) in the reconstruction cannot play an important role, either because they are calculated by simulation or they are considered globally. It seems that no systematic approach based on the study of the deformation of well identified vehicle

structural points has been tried so far. In the present work, the vehicle deformations have to be measured on the crushed parts, compared and submitted to basic statistical functions such as average value, standard deviation and variance in order to establish a quality score of the reconstruction.

Objective and Principles of the RQS Method

This method is intended to help experts to assess the quality of the reconstruction of a real world accident in terms of correlation of dissipated energy between a vehicle involved in a real world accident and its homologue used for the reconstruction.

For this purpose, a “Reconstruction Quality Score” based on the deformations of the main relevant vehicle body parts – longitudinal members, damper housing, A-pillar, foot well, etc, (see figure and table in annex) – is calculated.

There is an infinite number of ways to calculate a reconstruction quality from the comparison of vehicle deformations. The present work, after an extensive comparison of various candidate indicators and score weighing methods, led to define a composite score based on:

- The absolute values of the deformation differences
- The relative values of the deformation differences:
- weighing factors depending on the deformation variability at each considered point and depending on its position with respect to the impact point

For each point, a score is computed from an absolute and a relative deformation indicator and then, all scores are weighted and mixed in order to give a global quality score.

Definition of Deformation

The deformations values are obtained by measurement of the location of relevant points on the car body, before and after the crash (see figure in annex 1). They are projected on relevant vehicle axes:

- the longitudinal components of the deformations, for the frontal collision
- the transversal components of the deformations, for the lateral collision

D_{acc} is the deformation on the real world accident vehicle whereas D_{rec} represents the deformation sustained by the vehicle used in the reconstruction.

Indicators Evaluated to Calculate the Local Reconstruction Quality Score

The simpler deformation indicator is the absolute one:

$$I_{abs} = | D_{acc} - D_{rec} |$$

Of course, an absolute difference between two deformations does not have the same meaning if the deformations are small or large. A 1cm difference between 5 and 6cm is not the same as a 1cm difference between 99 and 100 cm. To deal with this problem, a relative indicator can be considered:

$$I_{rel} = | D_{acc} - D_{rec} | / | D_{acc} |$$

But, at low deformation values, the relative indicator can lead to unrealistic values. For instance, in a real accident D_{acc} can be very small, even zero, while D_{rec} can take any value. In this case, the values of I_{rel} cannot be considered reliably.

In fact, both absolute and relative differences values have to be taken into account for the following reasons. In a real word collision at low speed, for instance, with an average real world deformation value of 10cm, if the deformation recorded for its reconstruction is 20cm, the absolute difference value I_{abs} is 10 while the relative difference value I_{rel} is 100%. In this case the score based on the I_{rel} would be nearly “0”. However, since car peripheral stiffness is low, experts consider in such cases that the crash test is acceptable. Consequently, for low energy crashes, I_{abs} will be considered for establishing the score.

On the opposite, for high severity situation, with deformation values ranging from 80cm up to 120cm, it is preferable to consider I_{rel} : a difference of 10cm in this range represents a I_{rel} of 8.3 to 12.5%. For such values experts decide that correlations can be validated.

A lot of other indicators have been tested and compared, but none of them could bring a decisive advantage; hence the two first indicators described above have been kept. The absolute indicator is used for deformation under a maximum value D_{max} ; the relative indicator is used only if the deformation difference is smaller than the absolute deformation measured in the accident:

$$|D_{acc} - D_{rec}| < |D_{acc}|$$

Then, a local score, ranging from 0 to 10, is calculated from the indicator using a function. The simplest function is the linear one giving a decreasing score along with an increasing deformation difference (figure 1). When the difference reaches D_{max} , the score drops to zero:

$$S_{abs} = 10 - (10/D_{max}) * I_{abs}$$

Other functions have been also considered (parabolic, hyperbolic, exponential) for calculating the local score. A good result comes from the exponential one especially with the relative deformation indicator (figure 2).

$$S_{rel} = \exp(-(I_{rel}/100)^{a/b})$$

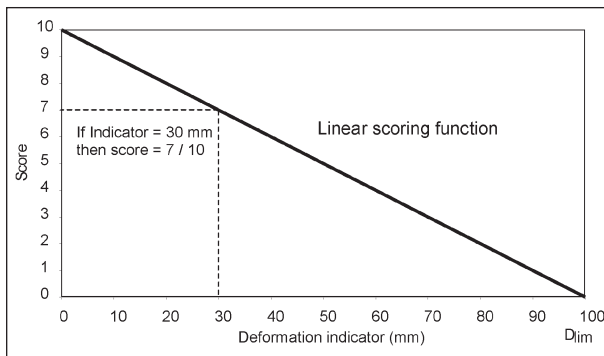

Fig. 1: Linear function giving the score as a function of absolute deformation

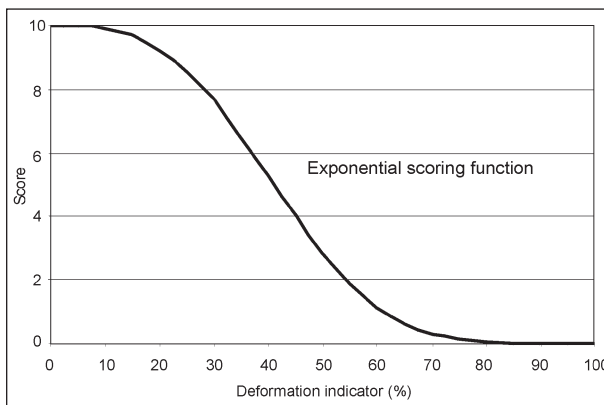

Fig. 2: Exponential function used to built the score from relative deformation

With appropriate values of a and b, the score drops rapidly to zero when the deformation indicator goes beyond a certain percentage, eliminating too high relative deformations.

Then, the reconstruction quality score RQS_i can be built for a given point P_i . It includes several terms weighted by 2 coefficients α and β :

$$RQS_i = \alpha S_{abs1} + (1 - \alpha) [\beta S_{abs2} + (1 - \beta) S_{rel}]$$

The coefficients α and β determine the ratio between absolute and relative differences used for the calculation of RQS. These coefficients depend on thresholds D_{lim} and E_{lim} and on the value of γ_1 and γ_2 . These two last parameters determine the slope of the curves defining the values of α and β respectively. These coefficients are determined according to the following expressions:

$$\alpha = 1 \quad \text{if } D_{moy} = (D_{acc} + D_{rec})/2 < D_{lim}$$

$$\alpha = \exp(-1 * ((D_{lim} - D_{moy})/D_{lim})^2 / \gamma_1) \quad \text{otherwise}$$

$$\beta = \exp(-1 * ((E_{lim} - |D_{acc} - D_{rec}|) / E_{lim})^2 / \gamma_2) \quad \text{if } |D_{acc} - D_{rec}| < E_{lim}$$

$$\beta = 1 \quad \text{otherwise}$$

The values of D_{lim} , E_{lim} , γ_1 and γ_2 can be tuned in order to get the best correlations between the RQS and the evaluation given by the experts as described later on. The variation of α along with increasing average deformation (D_{moy}) is depicted by curves of figure 3. Variations of β with increasing deformation differences are depicted by curves of figure 4.

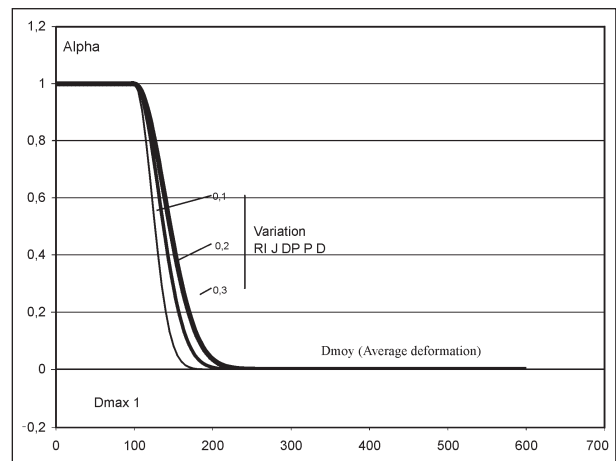

Fig. 3: Variation of coefficient α as a function of the average of the deformations measured on the real world vehicle and on the reconstruction vehicle. D_{lim} and γ_1 condition the shape of the curve

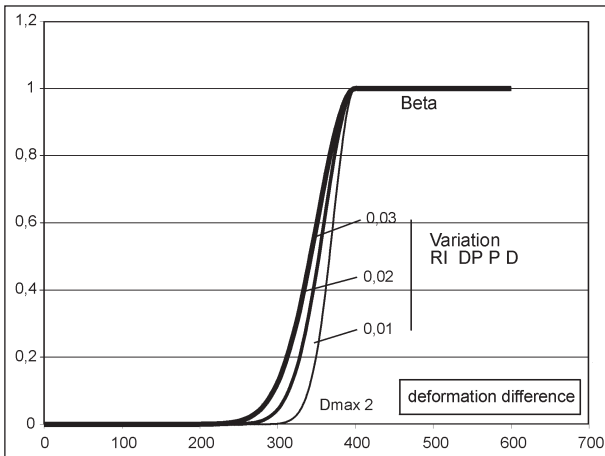

Fig. 4: Variation of coefficient β as a function of the relative difference of deformations measured on the real world vehicle and on the reconstruction vehicle. E_{lim} and γ_2 condition the shape of the curve

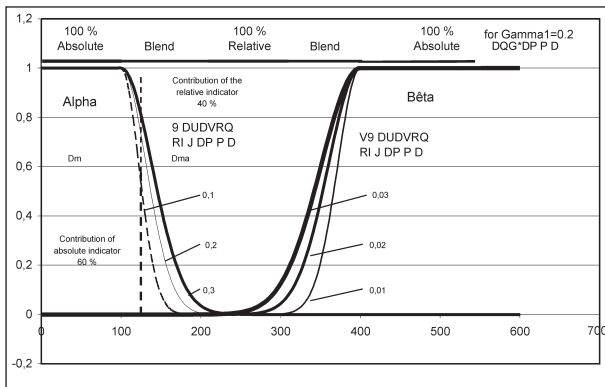

Fig. 5: Evolution of parameters α and β along with deformation and contribution of absolute and relative indicators in the score definition

Weighing Factors

Weighing coefficients (W) are assigned to the reference points measured on the vehicle structure. The values of these coefficients have been calculated from about 26 accident reconstructions selected in the CREST¹ database. Measured structure deformations have been normalised taking into account the global energy dissipated in the crash (weight and speed of the car(s)):

- For every point, standard deviations have been determined.
- Statistical calculation led to weighing factor values which are inversely proportional to the variance ($W_i = 1/\sigma_i^2$).

The variability of the deformations measured at various points of the vehicle structure is graphically shown in figure 6. For each point, this variation is expressed by the standard deviation converted into a percentage value. Its value partly depends on the distance separating the considered point and the initial impact point. The value of the standard deviations for different structure points have been calculated on 43 cases of reconstructed frontal-left collisions. They are given in table 1 sorted by increasing order of deviation magnitude.

¹ CREST = EC funded project devoted to the safety of children transported in automobiles (1996-2000)

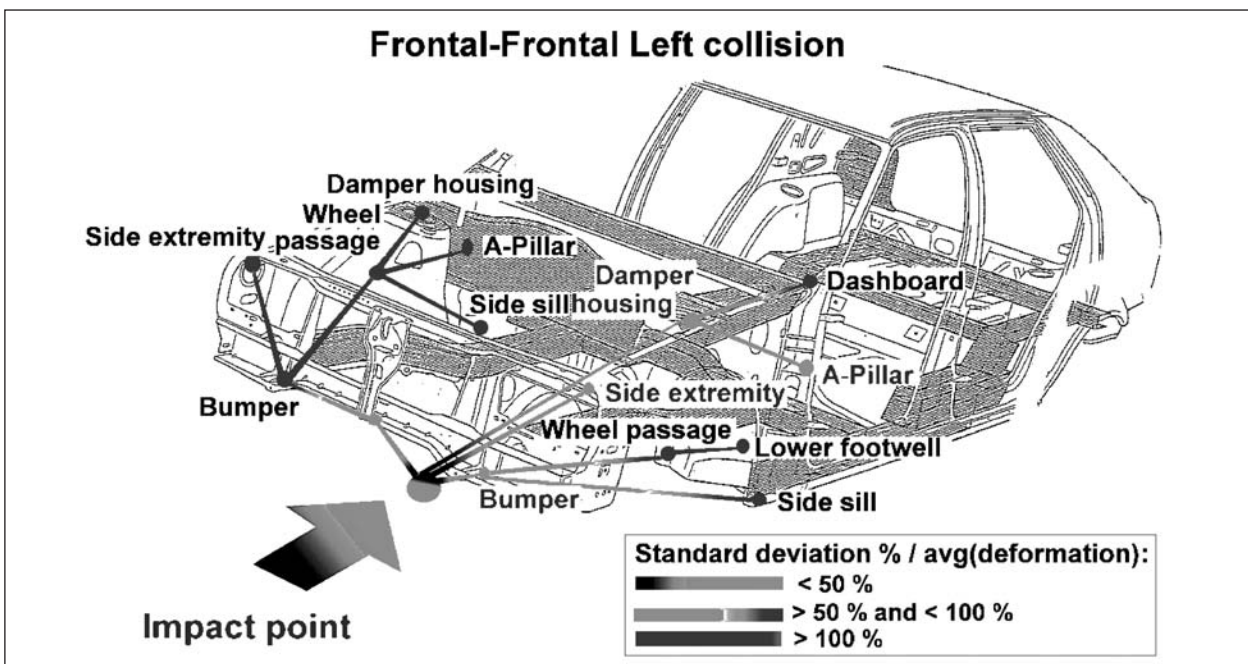

Fig. 6: Variability of deformations measured at various locations of the vehicle structure

Structure control points	Standard deviation %	Mean deformation (mm)	Number of cases
Max Intrusion	29	-863	24
Bumper Left	30	-735	14
Extremity Left	30	-889	9
Side Extremity Left	34	-837	10
Damper Housing Left	44	-410	20
Vehicle Axis	45	-655	20
A-Pillar (Front Pillar) Left	61	-206	20
Wheel Base Left	67	-348	23
Bumper Right	75	-288	13
Dashboard Left	76	-213	23
Upper Footwell Occ Axis Left	76	-190	18
Upper Footwell Left	86	-206	8
Side Sill Left	88	-208	19
Upper Footwell Occ Axis Right	99	-57	19
Lower Footwell Right	110	-44	10
Extremity Right	115	-193	8
Side Extremity Right	118	-241	8
Lower Footwell Left	120	-169	10
Upper Footwell Right	139	-22	8
Damper Housing Right	144	-81	20
A-Pillar (Front Pillar) Right	192	-22	20
Dashboard Right	215	-40	23
Side Sill Right	527	-4	19
Wheel Base Right	5164	-2	22

Tab. 1: Deformation variability for various structure points calculated on 26 reconstructions of frontal left collisions (CREST database)

Global Reconstruction Quality Score

The global reconstruction quality score is the weighted sum of local quality scores for all the points of the structure

$$RQS = \frac{\sum_{i=1}^n RQS_i \times \frac{1}{\sigma_i^2}}{\sum_{i=1}^n \frac{1}{\sigma_i^2}}$$

Where:

- n is the number of measured points
- RQS_i is the score for every point P_i
- σ_i^2 the variance for point P_i

Reliability of the Score

It is essential to take into account that all the measurements points could not be available for calculation. In such cases, the method can be used but obviously, the reliability of the score is reduced. The calculation of the reliability is based on the following formula:

$$\text{Reliability (\%)} = \left(\frac{\sum_{i=1}^n \frac{1}{\sigma_i^2} \times 100}{\sum_{i=1}^{n'} \frac{1}{\sigma_i^2}} \right) - Cste$$

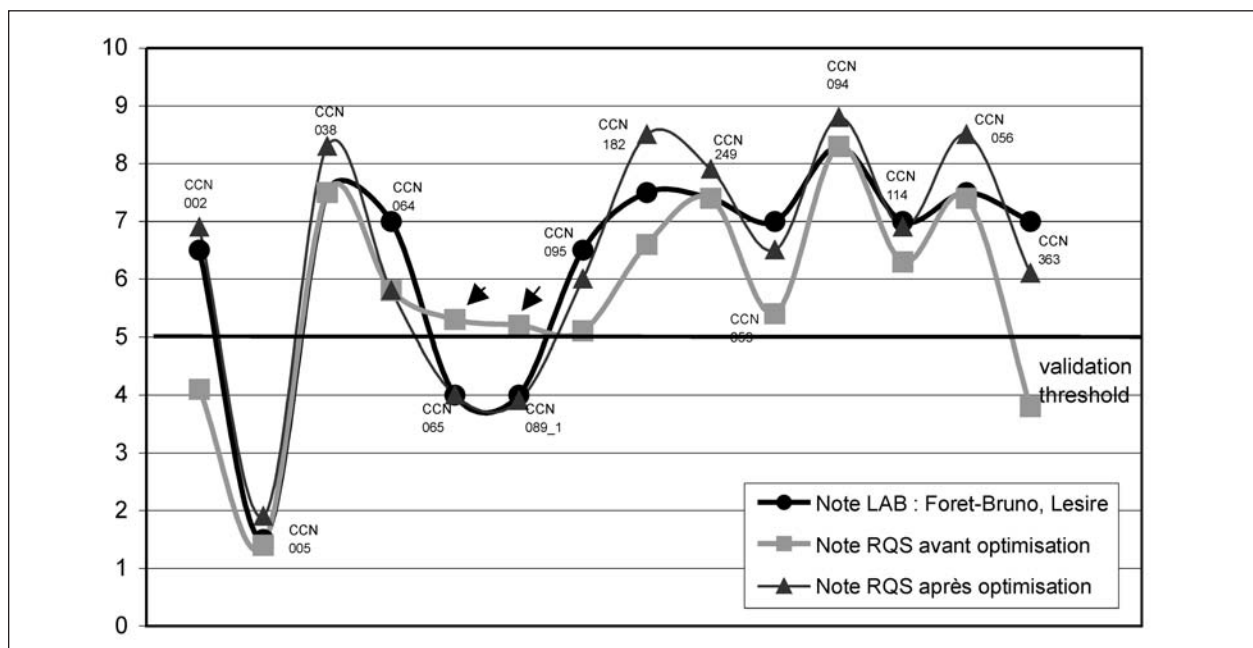

Fig. 7: Score values before and after adjustment of the α and β coefficient to match the experts' scores on several accident reconstructions

Where n is the number of points considered for the calculation of the score and n' is the total number of points of the structure. Thus, the reliability depends not only on the number of measured deformations but on the weight of the considered body component too.

Validation of the RQS Method

In a first phase, the weighing factors were discussed, adjusted and validated with the accidentologists of the LAB Renault Peugeot Citroën. Then, calculated scores and scores empirically assessed were compared in order to tune the values of parameters α and β . Finally, a genetic algorithm was used to find their optimum values. On figure 5 are shown the score values for different accident reconstructions. The three curves correspond respectively to the expert scores, the calculated scores before optimisation and the calculated scores after optimisation.

Complementary Application of the RQS Method

The results of the calculations and more particularly the average value of deformation furthermore enable:

- the adjustment of the speed for another reconstruction;
- the calculation of the precise velocity and pulse characteristics for sled tests if parametric tests are necessary to complement the full scale test (see figure 6).

The calculation is based on the principle that the average deformation is linked to the change of velocity. The adjusted velocity and deceleration pulse (for the sled) are determined owing the following hypotheses:

- The average weighed sum of the deformations is proportional to the displacement calculated by double integration of vehicle acceleration; hence the lack or excess of deformation may be used to adjust the vehicle velocity.
- The crushing force acting on the car body remains constant when the deceleration plateau is reached and the deformation difference is due to a different duration of the deceleration plateau.

These hypotheses enable the calculation of the correct test car velocity which will generate the same deformations as those observed on the real world accident car.

Conclusion

The RQS method is an attempt to help accidentologists to get a more objective evaluation of the quality of accident reconstructions performed in order to better identify injury mechanisms and establish injury risk curves. It seems that no previous such attempt has been conducted so far.

The method is parametric which enables to easily take experts' experience into account. Its reliability will improve significantly with the increase of the number of cases included in the data base.

A first validation of the method and of the software has been obtained owing to the accident reconstructions performed in the frame of the CREST programme. This will be continued with the reconstructions performed in the CHILD programme.

Presently, only reconstructions of frontal collisions can be analysed. Further development is needed to deal with other crash configurations such as lateral impact and rear impact.

Of course, the method can be improved, particularly in adjusting the weighing factors. This progress will be possible if a large number of laboratories use this tool and return the results to the developers.

Acknowledgement

The authors thank Ph. LESIRE and J. Y. FORET-BRUNO from PSA-RENAULT Accidentology laboratory for their valuable expert help in calibrating and evaluating the RQS method against real cases.

References

- McHENRY, B. G., & McHENRY R. R. (2003) SMAC2003: The automatic iteration of SMAC. Proc. of "Accident reconstruction 2003", SAE SP-1773, SAE editor, Warrendale PA., pp. 15-27
- MOSER, A., STEFFAN, H., SPEK, A. & MAKKINGA, W. (2003): Application of the Monte-Carlo methods for stability analysis within the accident reconstruction software PC-CRASH. Proc. Of "Accident reconstruction 2003", SAE SP-1773, SAE editor, Warrendale PA., pp. 39-51

ANNEX 1

Relevant Vehicle Body Part Points Used for Calculation

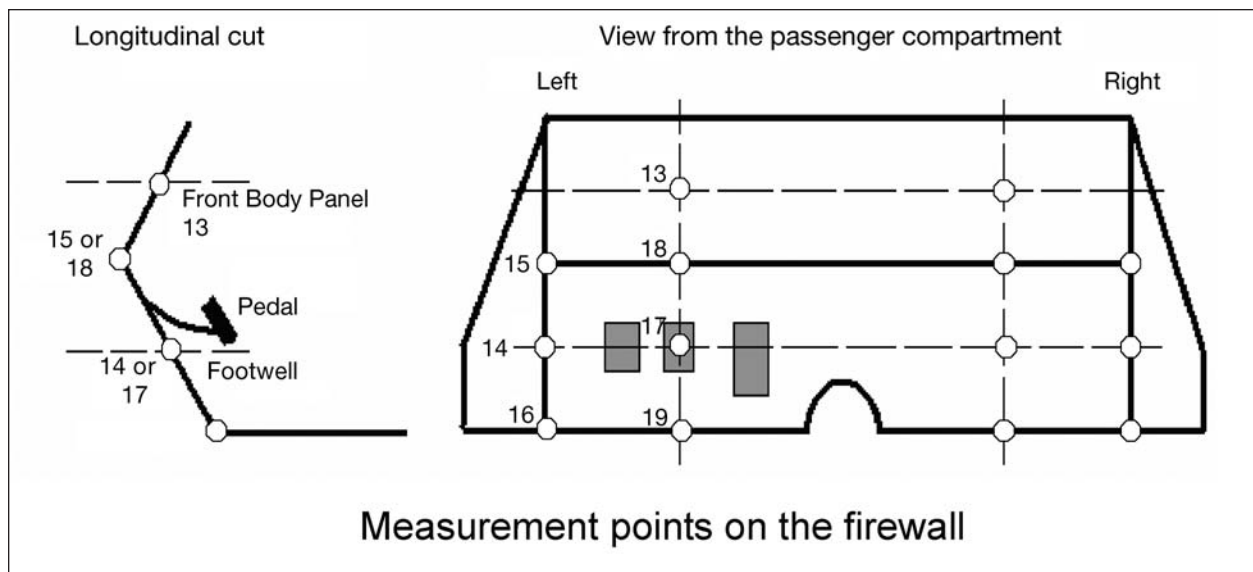
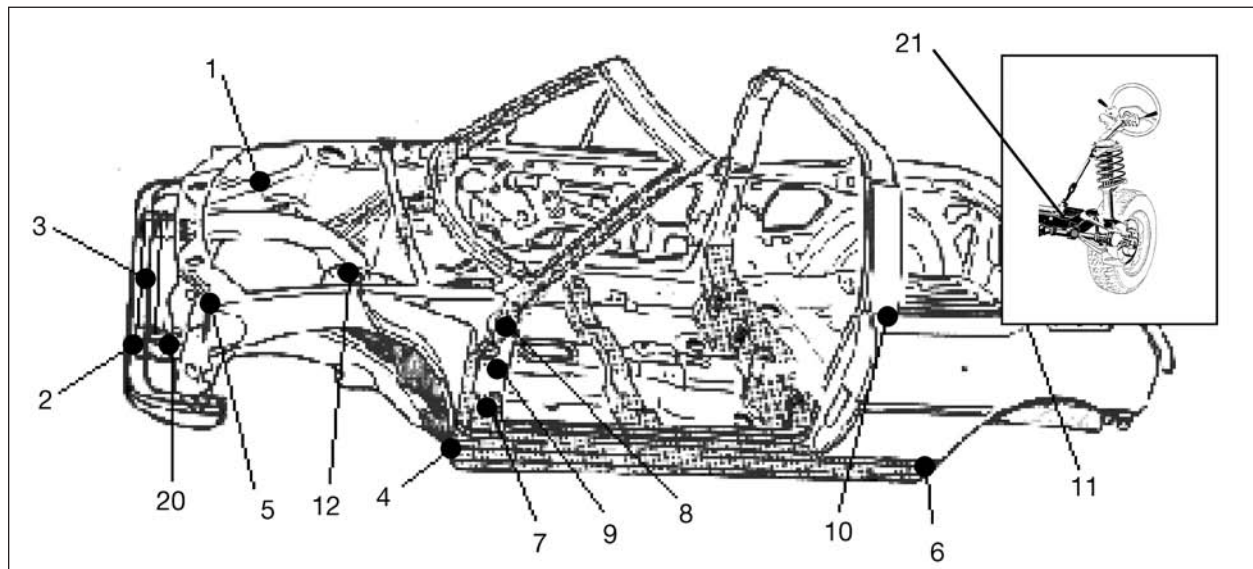

Points #	Designation	Points #	Designation
1	Wheel Passage (Upper part)	12	Damper Housing
2	Bumper	13	Front Body Panel
3	Bumper Centre (Vehicle Axis)	14	Middle Foot well
4	Side Sill	15	Upper Foot well
5	Side Extremity	16	Lower Foot well
6	Rear Side Sill	17	Middle Foot well occ. Axis
7	Bottom A-Pillar	18	Upper Foot well occ. Axis
8	Middle A-Pillar	19	Lower Foot well occ. Axis
9	Top A-Pillar	20	Longitudinal Beam
10	B-Pillar	21	Unit/Lower wheel arm attach point
11	C-Pillar	22,23	Dashboard, Dashboard Centre

Annex 2: The RQS Software

Entering the Deformation Values

Chapter 1 : Score of the reconstruction

3. Fill the second window to calcul the score and its reliability

A. The deformation points on the vehicle' structure

The screenshot shows two windows. The left window, titled "Location of deformation / intrusion points on vehicle structure", displays a 3D wireframe of a car with numbered points (1-21) and a 2D longitudinal section of the body panel with points 13-19. The right window, titled "Deformations of the vehicle' structure", shows a table with columns for COLLISION TYPE, POINTS #, DEFORMATIONS (Accident, Crash), and WEIGHTS. A red box highlights the "Points #" column, with an arrow pointing to the "Points #" column header and the text "Press the 'Points #' button". Another red box highlights the "Accident" and "Crash" columns, with an arrow pointing to the "Accident" column header and the text "Control Points (Left and Right)".

POINTS #	DEFORMATIONS		WEIGHTS
	Accident	Crash	
1. Wheel Passage (Upper part) LEFT	0.0	0.0	0.0
1. Wheel Passage (Upper part) RIGHT	0.0	0.0	0.0
2. Bumper LEFT	0.0	-830.0	10.9
2. Bumper RIGHT	0.0	-60.0	3.55
3. Bumper CENTER (Vehicle Axis)	-1255.0	-1820.0	7.27
4. Side SB LEFT	516.0	380.0	3.23
4. Side SB RIGHT	39.0	0.0	0.38
5. Side Extremity LEFT	-1430.0	-1810.0	7.81
5. Side Extremity RIGHT	-215.0	0.0	2.43
6. Rear Side SB LEFT	0.0	0.0	0.0
6. Rear Side SB RIGHT	0.0	0.0	0.0

Visualising the Entered Deformation Values and the Corresponding Weighing Factors

Chapter 1 : Score of the reconstruction

3. Fill the second window to calcul the score and its reliability

B. Deformation values

Deformation of the accidented car in the reconstruction

Press the Barchart button in the menu bar

The screenshot shows two windows. The left window, titled "Deformations of the vehicle' structure", shows a table with columns for COLLISION TYPE, POINTS #, DEFORMATIONS (Accident, Crash), and WEIGHTS. The right window, titled "Barchart: deformations on the vehicle's structure", shows a bar chart with the following data:

POINT	Accident (mm)	Reconstruction (mm)	Weight
1. Wheel Passage (Upper part) LEFT	0.0	0.0	0.0
1. Wheel Passage (Upper part) RIGHT	0.0	0.0	0.0
2. Bumper LEFT	-830.0	0.0	10.9
2. Bumper RIGHT	-60.0	0.0	3.55
3. Bumper CENTER (Vehicle Axis)	-1255.0	-1820.0	7.27
4. Side SB LEFT	516.0	380.0	3.23
4. Side SB RIGHT	39.0	0.0	0.38
5. Side Extremity LEFT	-1430.0	-1810.0	7.81
5. Side Extremity RIGHT	-215.0	0.0	2.43
6. Rear Side SB LEFT	0.0	0.0	0.0
6. Rear Side SB RIGHT	0.0	0.0	0.0

Deformation of the accidented car in the real accident

NB. : Unit of the deformation is mm
The sign of a deformation is usually negative

Red bar for the deformation of the accident
Blue bar for the deformation of the reconstruction
Darkness of the color of bars is proportionnal to the weighting factors

Calculation of Score and Reliability

Chapter 1 : Score of the reconstruction

3. Fill the second window to calculate the score and its reliability

D. Calculate the score of the reconstruction

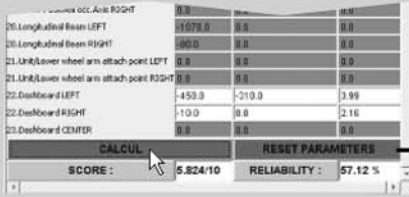

20. Longitudinal beam LEFT	1070.0	0.0	0.0
20. Longitudinal beam RIGHT	990.0	0.0	0.0
21. LH/Lower wheel arm attach point LEFT	0.0	0.0	0.0
21. LH/Lower wheel arm attach point RIGHT	0.0	0.0	0.0
22. Dashboard LEFT	-450.0	-210.0	1.99
22. Dashboard RIGHT	-10.0	0.0	2.16
23. Dashboard CENTER	0.0	0.0	0.0

SCORE : 5.824/10 RELIABILITY : 57.12 %

Press the CALCUL button to have the score and its reliability
The reliability depends on the number of using points and on the weight of these points

The RESET PARAMETERS button set the weighting factors to init values

RQS Database Functions

Chapter 2 : RQS Database

2. Consult the database

Select cases in database



1 Structure and informations
2 Consult the Database
3 Insert Case
4 Delete Case
5 Update the weighting factors

2. Consult the Database

- Type of collision :
1 Frontal-Frontal Left

- Case Number :

Vehicles Speed Laboratory

002 : Renault R21 - Volkswagen Scirocco ** Laboratory : LAB
005 : Renault R21 - Peugeot 309 GR ** Laboratory : Fiat Auto S.p.a.
007 : Ford Escort - Peugeot 205 ** Laboratory : BIRETS
028 : Opel Kadett - Volkswagen T3 ** Laboratory : BAST
030 : Citroen ZX - Peugeot 205 ** Laboratory : LAB
064 : Renault R19 - Volkswagen Jetta ** Laboratory : LAB
065 : Citroen BX - Citroen ZX ** Laboratory : Fiat Auto S.p.a.
089 : Renault Mégane Coupé - Volkswagen Golf 1 GTI ** Laboratory : Fiat Auto S.p.a.
089 : Renault Mégane - Volkswagen Golf 1 GTI ** Laboratory : LAB
095 : Renault R19 - Renault Super 5 GTD ** Laboratory : Fiat Auto S.p.a.
099 : Volkswagen Golf II - Peugeot 106 XS ** Laboratory : Fiat Auto S.p.a.
123 : BMW 318 - Fiat Ritmo ** Laboratory : Fiat Auto S.p.a.

Select All

Consult the selected case

Select cases by type of collision

Select parameters to print in the select window

Select window :
Ctrl key to select various cases

Select all cases in the select window

RQS Database: Access to the Stored Cases and Score Calculation

Chapter 2 : RQS Database

2. Consult the database

Case number view

Previous Next case

Select All Consult the selected case

Press Consult button to see the selected cases

Press "Create *.rqs File" button and open your RQS project to calculate the score of this case

Open 099.rqs file

Window REAL Accident

Window Reconstruction

The screenshot shows the 'RQS Database - Case Number' window with case 099 selected. A 'Consult the selected case' button is highlighted. A callout box instructs the user to 'Press "Create *.rqs File" button and open your RQS project to calculate the score of this case'. Below, the 'REAL ACCIDENT' and 'RECONSTRUCTION' data tables are visible. The 'REAL ACCIDENT' table includes fields like Make (Volvo), Model (S40), and Weight (1215.0 kg). The 'RECONSTRUCTION' table shows details for the 'Accident Vehicle' (Citroen XE) and 'Opposite Vehicle' (Renault K21). Below these are 'DEFORMATION LEFT/RIGHT' and 'DEFORMATION LEFT/RIGHT (mm)' tables with various impact points and their corresponding deformation values.

RQS Database: Insertion of a Case

Chapter 2 : RQS Database

3. Insert Case

A. Insert new case : manual

Verify the informations and press the Insert button to insert your new case in the RQS Database

Press the Return button to return to the form

Return

Complete the fields

Valid

and then press the valid button

The screenshot shows the 'RQS Database - Insert new case' window. A '3. Insert Case in the RQS Database' dialog is open. A callout box says 'Verify the informations and press the Insert button to insert your new case in the RQS Database'. Another callout says 'Press the Return button to return to the form' with an arrow pointing to the 'Return' button. A third callout says 'Complete the fields' with an arrow pointing to the input fields. A fourth callout says 'Valid' with an arrow pointing to the 'Valid' button, followed by 'and then press the valid button'. The background shows the 'RQS Database - Case Number' window with case 999 selected, displaying the same data tables as in the previous screenshot.

RQS Database: Up-Dating the Database at Inrets

Chapter 2 : RQS Database

3. Insert Case

D. Create a *.rdb file : export all new cases

Press the Export button



Save your *.rdb File : it contains all the new cases
Please, send this file to INRETS LBMC
in order to have a common database

A IE window will be automatically open



Insert your *.rdb file in your attached file

Send a mail to @inrets.fr

Calculation and Curve Edition Funktions

Chapter 3 : RQS Diagram

2. General presentation

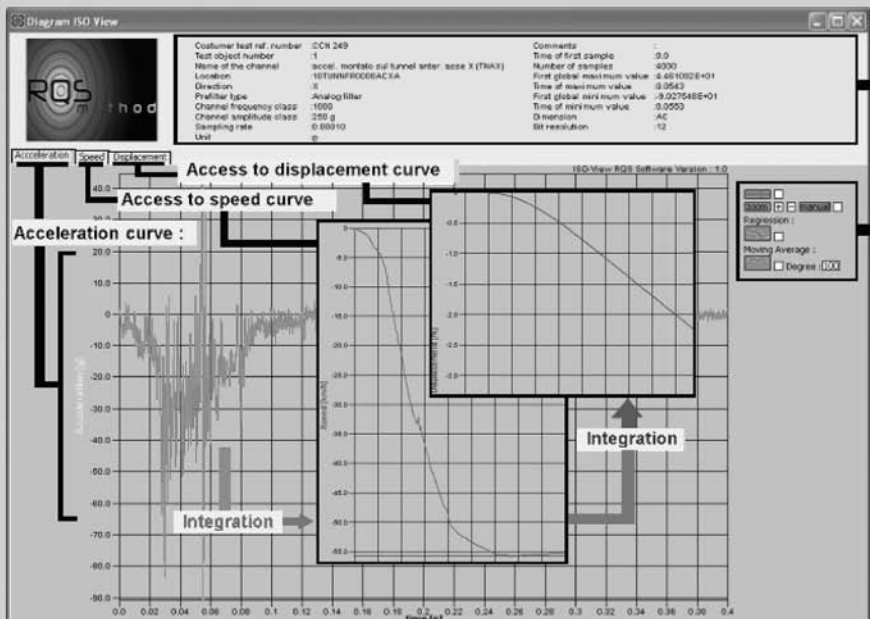

Customer test ref: number : CCR 249
Test object number : 1
Name of the channel : accel. montelo cul tunnel enter. esse X (THUX)
Location : 16TBNFR000GACSA
Direction : X
Profile type : Analog filter
Channel frequency class : 1000
Channel amplitude class : 250 g
Overriding rate : 0.00010
Unit : #

Comments :
Time of first sample : 0.0
Number of samples : 4000
First global maximum value : 4.451002E+01
Time of maximum value : 0.0543
First global minimum value : -9.027548E+01
Time of minimum value : 0.0593
D version : AC
Bit resolution : 12

Access to displacement curve
Access to speed curve
Acceleration curve :
Integration
Integration

Information about the test and the curve (contained in the ISO File)

Tool box :
measurement tool
Zoom
Regression
Moving average

Calculation of Moving Average

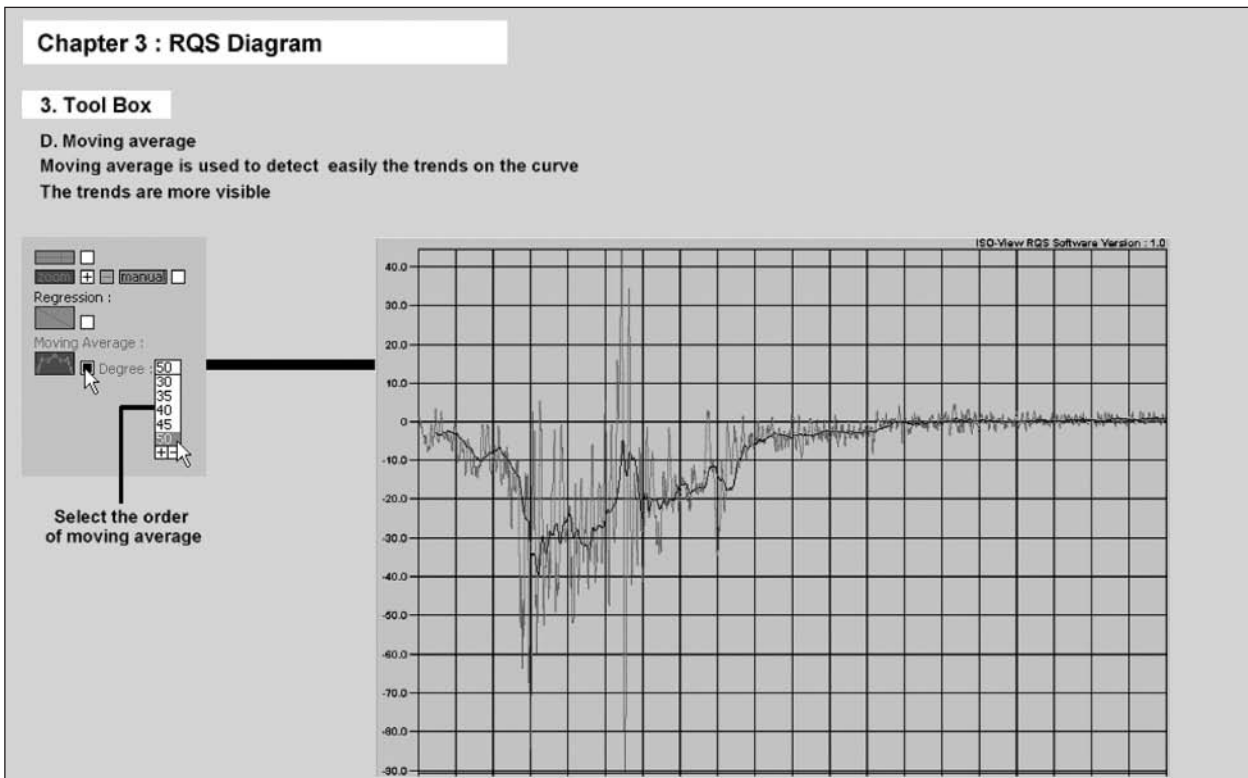

Calculation of a Sled Pulse based on the Deceleration of the Case Vehicle

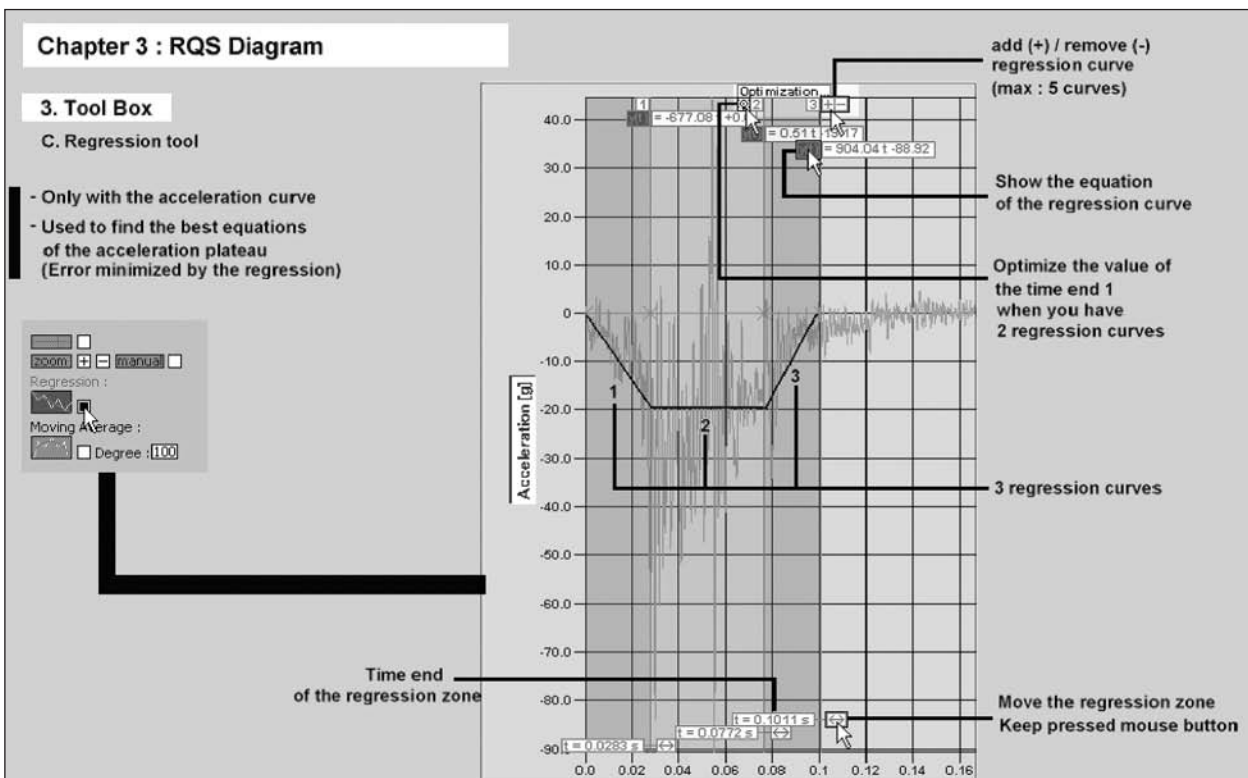

Adjustement of the Speed for a Second Reconstruction or for Determination of Initial Speed and Deceleration Law of the Sled Used for Complementary Parametric Tests

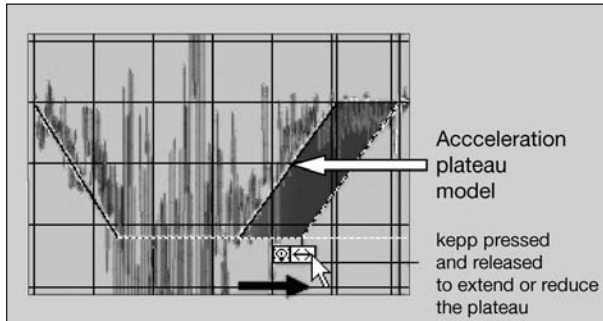

The effect of extension or reduction of the plateau length in terms of speed and displacement is calculated and visualised. The right adjustment value is reached when the effect on displacement corresponds to the difference of average deformations between the accidented and the tested vehicle.

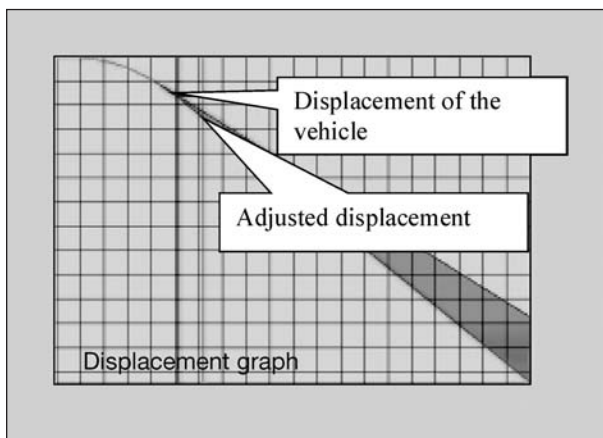
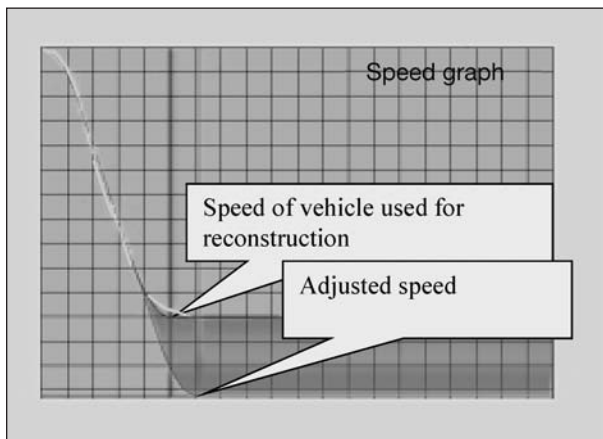

**Session: Regulation, Consumer Aspects and Methodology –
Part II**

C. Pastor

G. Gugler, H. Steffan, G. Lutter, S. Fleischer

J. M. Barrios, S. J. Busby, J. Huguet, V. Salvachúa, G. Tejera

U. Grömping, S. Menzler, U. Weimann

R. Choiejit, R. Teungfung

R. Nagel

C. Pastor
Federal Highway Research Institute,
Bergisch Gladbach, Germany

Target Population of Improved Compatibility for Germany

Abstract

In spite of today's highly sophisticated crash test procedures like the different NCAP programs running world-wide, bad real world crash performance of cars is still an issue. There are crash situations which are not sufficiently represented by actual test configurations. This is especially true for car to car, as well as for car to object impacts. The paper describes reasons for this bad performance. The reasons are in principal bad structural interaction between the car and its impact partners (geometric incompatibility), unadjusted front end stiffnesses (stiffness incompatibility) and collapse of passenger compartments.

To show the efficiency of improving cars' structural behaviour in accidents with different impact partners an accident data analysis has been taken out by members of the European Project VC-COMPAT. Accident data analysis has shown that in Germany between 15,000 and 20,000 of the now severely injured car occupants might get less injured and between 600 and 900 car occupant fatalities might be saved. Similar results arise for the UK.

Introduction

In 2001 there were, according to the European Commission, 39,684 traffic accident deaths in the 15 member states of the EU, out of a population of 377,942,000 (Commission of the European Communities 2003 [1]). These fatalities are defined to the UN/WHO criterion of a death occurring within 30 days of the crash. This still huge amount of deaths on European roads is the reason for an increasing number of traffic safety policies being initiated at European Union level. Therefore it should be noted that in a number of areas, such as vehicle-safety design, the European Commission has total competence, in other words, total responsibility to introduce directives which have the power of law behind them.

In October 1998, the first European Frontal and Side Impact Directives became effective. It is widely recognised that improved vehicle crash compatibility is the next greatest potential benefit for improving car occupant safety. Moreover the European Commission has set a target for traffic fatalities to be reduced by 50% by 2010 (compared to 2000) and improving passenger car compatibility is thought to be one major step towards that aim.

The general objective of the European research project 'Improvement of Vehicle Crash Compatibility through the Development of Crash Test Procedures' (VC-COMPAT) is to contribute in reducing the number of injured and killed car occupants involved in frontal passenger car collisions. Therefore a suite of crash test procedures is to be developed, which once implemented in legislative and/or consumer testing will lead to an improved vehicle crash compatibility.

In a first step a benefit estimation of compatibility has been made, by assessing the target population. This is the number of road casualties which are going to benefit from taking compatibility measures. Details of the methodology as well as first results for Germany and the UK are presented in the subsequent chapters.

Methodology

Accident data from the GIDAS (German In-Depth Accident Study) and from the CCIS (Cooperate Crash Injury Study) sample have been used. Detailed information regarding both databases can be found elsewhere [2]. The car occupant casualty data were broken into categories by impact partner and first point of impact. It was assumed that there would only be potential benefit for casualties, involved in frontal impact collisions, i.e. no potential benefit for casualties in side, rear and other impact collisions.

The reason for breaking down the data in this manner was that it was thought that the relative potential benefit of improved compatibility for each of these groups would be quite different, therefore they needed to be treated separately. For example, improved compatibility is expected to deliver its greatest benefit for the frontal impact with another car.

figure 1 therefore shows the portion of different impact partners in fatal frontal car collisions for Germany in the year 2000.

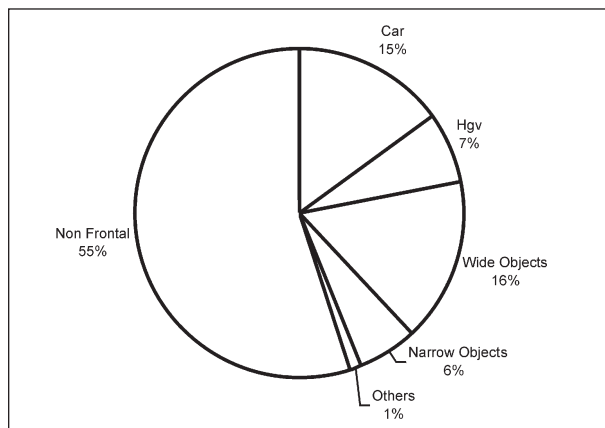

Fig. 1: Impact partners in fatal frontal car collisions for Germany in the year 2000

For each of the frontal impact partners a data subset was derived to estimate the proportion of fatal and seriously injured casualties that were likely to experience a potential benefit from improved car compatibility. This was achieved by considering parameters such as overlap, impact severity and the impact principle direction of force (pdof). For each of these parameters a lower (pessimistic) and an upper (optimistic) estimate was made for which a potential benefit would be expected as a result of implementing improved compatibility. The results were combined to give a somewhat optimistic and a somewhat pessimistic estimate of the accident subset in which the casualties could be expected to experience a potential benefit. The number of casualties in each of these accident subsets was determined. These were compared to the number of casualties in the originally derived equivalent data subset to determine a lower (pessimistic) and upper (optimistic) bound for the proportion of fatalities and seriously injured that would be expected to see a potential benefit from improved compatibility.

An upper and lower estimate of the number of fatalities and seriously injured casualties that would be expected to see a potential benefit for improved compatibility, annually in Germany and GB, was determined by scaling the results obtained from the analysis using the GIDAS data subset to the national accident data.

Definition of Data Subsets According to Impact Partner

Car to Car Collisions

The definition of a suitable data subset by some accident parameters (like overlap, impact severity,

Selection criterion	optimistic limit	pessimistic limit
impact location	frontal	frontal
overlap	>20%	>30%
pdof	10..2 o'clock	11..1 o'clock
EES/ETS	all accidents up to 56kph + 50% of them up to 80kph	all accidents up to 48kph + 50% of them up to 80kph
mass ratio	all mass ratios	>1 : 1,6
belt usage	only belted occupants	only belted occupants
occupants	only frontal occupants	only frontal occupants
multiple impacts	no subsequent significant side impact	no subsequent significant side impact or rollover; exclude cases where the side impact or the rollover is judged to be more injurious than the frontal impact

Tab. 1: Upper and lower limits for accident parameters used to identify proportion of fatalities and seriously injured expected to experience a potential benefit for car to car collisions

etc.) is fully illustrated for the car to car frontal accidents.

The accident parameters considered for the category, car frontal impact with another car or van, were: impact direction, overlap, multiple impacts, rollover and accident severity. The lower (somewhat pessimistic) and upper (somewhat optimistic) limits, showed in Table1 below, were chosen and used as selection criteria to determine the proportion of fatalities and seriously injured in the GIDAS/CCIS equivalent data sample sub-set that would be expected to experience a potential benefit. Some reasoning to why the particular limits used were chosen is given below.

It is expected that improved compatibility should offer some potential benefit for frontal collisions with nearly all impact directions, except possibly those with a substantial side component. Therefore, an upper limit to include impacts with 10, 11 12, 1 and 2 o'clock principle direction of force (pdf) and a lower limit of 11, 12 and 1 o'clock pdf were chosen. In considering the limits for overlap, it is not expected that improved compatibility will offer significant benefits for side-swipe or low overlap accidents where the main structure of the car, such as the lower rails, is not involved. This is because it would be difficult to obtain good structural interaction in these cases. However, there are also approaches to overcome that problem [3]. So to exclude these accidents the upper and lower limits were set at 20 and 30 percent, respectively. Due to the high importance of multiple collisions, in particular with regard to fatal and serious casualties [4], multiple collisions have been included in the analysis, but treated in a

Selection criterion	optimistic limit	pessimistic limit
impact location	frontal	frontal
overlap	>20%	>30%
pdof	10..2 o'clock	11..1 o'clock
EES/ETS	all accidents up to 56kph + 50% of them up to 80kph	all accidents up to 48kph + 50% of them up to 80kph
delta v	all values	>56kph
underrun	exclude 80% of underruns	exclude 100% of underruns
belt usage	only belted occupants	only belted occupants
occupants	only frontal occupants	only frontal occupants
multiple impacts	no subsequent significant side impact	no subsequent significant side impact or rollover; exclude cases where the side impact or the rollover is judged to be more injurious than the frontal impact

Tab. 2: Upper and lower limits for accident parameters used to identify proportion of fatalities and seriously injured expected to experience a potential benefit for car to hgv collisions

Selection criterion	optimistic limit	pessimistic limit
impact location	frontal	frontal
overlap	>20%	>30%
pdof	10..2 o'clock	11..1 o'clock
EES/ETS	all accidents up to 56kph + 50% of them up to 80kph	all accidents up to 48kph + 50% of them up to 80kph
belt usage	only belted occupants	only belted occupants
occupants	only frontal occupants	only frontal occupants
multiple impacts	no subsequent significant side impact	no subsequent significant side impact or rollover; exclude cases where the side impact or the rollover is judged to be more injurious than the frontal impact

Tab. 3: Upper and lower limits for accident parameters used to identify proportion of fatalities and seriously injured expected to experience a potential benefit for car to wide object collisions

special way. Multiple impact accidents are those, where a car has impacted e.g. a roadside obstacle following a frontal impact. In some cases this secondary impact may be a side impact and more injurious than the frontal impact. Improved compatibility will probably not benefit these types of cases. To take this into account an upper limit to exclude all cases in which a significant¹ side impact occurred and a lower limit to exclude cases in which a significant side impact occurred and cases in which the other impact was judged to be more injurious than the frontal impact² were used. The accident data subset will also include some cases where the car has rolled over following the frontal impact. In some cases it is possible that the rollover was more injurious than the frontal impact. To take this into account an upper limit to include all accident cases in which rollover occurred and a

lower limit to include only rollover cases where the rollover was judged to be less injurious were used. Finally, impact severity was considered. Some potential benefit will be expected at almost all impact severities, but obviously this will be very small or zero in accidents of very high severity. To attempt to take this into account an impact severity limit was used, up to which all occupants are expected to experience potential benefit, but above which only half the occupants are expected to experience potential benefit. The upper value chosen for this limit was 56km/h ETS as this is widely believed to be a good approximation of the severity of the 64km/h ODB test, the severity up to which a 'compatible' car is expected to offer 'good compatible' performance. However, recent work has estimated the average ETS for a number of EuroNCAP tested cars (a 64km/h ODB test) to be 48 km/h. Hence, this value was used as the lower limit.

This methodology was repeated for cars that suffered an impact with a Hgv, with a wide object and with a narrow object. Similar accident case selection parameters and limit values were used. The following paragraphs give an overview.

Car to hgv Collisions (tabel 2)

In car to truck accidents the car is supposed to interact with some underrun protection system. A special "underrun criterion" was introduced to account for this. An additional crash severity ("delta v") criterion restricts the deceleration of the occupant to reasonable values.

Car to Wide Object (Diameter ≥ 41 cm) Collisions (tabel 3)

The selection criteria for car to wide object impacts look quite similar to those for the car to car accidents. Obviously there is no mass ratio criterion taken into account (Tab. 3).

Car to Small Object (Diameter ≤ 41 cm) Collisions (tabel 4)

No overlap criterion has been applied in the event of car to narrow object impacts. Instead another

¹ "Significant side impact" is defined as having a CDC extent code of at least 2.

² "Less injurious" assessment is based on the vehicle examiners' judgement of the relative likelihood of a particular part of the accident causing the serious injuries.

selection criterion	optimistic limit	pessimistic limit
impact location	frontal	frontal
pattern criterion	exclude cases with damage width less than 750mm, unless mid-point offset is less than 700mm	exclude all cases with damage width less than 750mm
pdof	10..2 o'clock	11..1 o'clock
EES/ETS	all accidents up to 56kph + 50% of them up to 80kph	all accidents up to 48kph + 50% of them up to 80kph
belt usage	only belted occupants	only belted occupants
occupants	only frontal occupants	only frontal occupants
multiple impacts	no subsequent significant side impact	no subsequent significant side impact or rollover; exclude cases where the side impact or the rollover is judged to be more injurious than the frontal impact

Tab. 4: Upper and lower limits for accident parameters used to identify proportion of fatalities and seriously injured expected to experience a potential benefit for car to small object collisions

criterion has been constructed, capable to describe the interaction with the car frontal structure. This criterion is the “pattern criterion” and it uses the damage width along the frontal damage contour.

Results

These accident selection parameters with the upper and lower limits were applied to the appropriate GIDAS/CCIS data subsets to estimate an upper (optimistic) and lower (pessimistic) bound to the number and proportion of fatalities and seriously injured casualties that are likely to experience a potential benefit as a result of improved compatibility. The results for Germany are shown in table 5 and table 6 below. The proportion of fatalities estimated to experience a potential benefit adds up to 14% to 21% of all car occupant fatalities. This corresponds to a number of 600 to 900 fatally injured occupants who might be saved by taking compatibility measures. It is also interesting to see, that there is a rather high potential benefit within the car to wide object category.

The proportion of seriously injured estimated to experience a potential benefit adds up to 29% to 39% of all seriously injured car occupants. This corresponds to a number of 15,000 to 20,000 occupants who might get less severely injured or even not injured. The highest potential benefit in this group is in the car to car category.

impact partner	weighted target population (belted occupants) using	
	pessimistic limits	optimistic limits
ca.	4%	8%
hgv	2%	3%
wide object	8%	10%
narrow object	0%	0%
others	0%	0%
Sum	14%	21%

Tab. 5: Target population for Germany regarding fatal car occupants

impact partner	weighted target population (belted occupants) using	
	pessimistic limits	optimistic limits
ca	20%	22%
hgv	2%	4%
wide object	3%	7%
narrow object	4%	5%
others	0%	1%
Sum	29%	39%

Tab. 6: Target population for Germany regarding seriously injured car occupants

A similar analysis of CCIS data gives slightly higher numbers for the target population in the UK. 20% to 31% of the fatally injured car front occupants might be saved in the UK by taking compatibility measures. This corresponds to a number of 340 to 540 casualties. Regarding the seriously injured car occupants 41% to 52% might have their injury reduced or even receive no injury. This corresponds to a number of 8,000 to 10,500 car occupants.

The differences between the German and British analysis seem to be caused by a different proportion of frontal collisions. In the UK frontal collisions have been responsible for 60% of all car occupant fatalities in the year 2000, while in Germany this proportion is about 45%. In addition various definitions of accident severity [5], in particular with regard to the term “seriously injured”, might be a reason for inconsistencies.

Although the mentioned figures are quite promising, a next step has to show exactly which injuries can be prevented by improving cars’ compatibility. Due to better structural interaction accompanied by a sufficiently stiff compartment cell the hope is to prevent most kind of intrusion-caused injuries. However, further detailed research has to justify this assumption.

References

- [1] Commission of the European Communities. European Road Safety Action Programme. Brussels, COM (2003) 311 final. 2.6.2003-10-31
- [2] <http://www.gidas.org>, <http://www.ukccis.org.uk>
- [3] WINKLER, St.: Verbesserung des Kollisionsverhaltens von Fahrzeugen bei teilüberdeckten Frontalunfällen zur Reduktion der Insassenbelastungen; Dissertation TU Graz, Austria 2001
- [4] FAY, SFERCO, FRAMPTON: "Multiple Impact Crashes Consequences for occupant protection measures. Proc. Ircobi Conf., 2001
- [5] MacKAY, M.: "National Differences in European Mass Accident Data Bases". Proc. Ircobi Conf., Lisbon, Sept. 2003-10-31

J. Gugler, H. Steffan
 Graz University of Technology, Institute on
 Mechanics, Graz, Austria
 G. Lutter, S. Fleischer
 Delphi Deutschland GmbH, Electronics & Safety,
 Vehicle Safety Laboratory, Berlin, Germany

Rollover Scenarios in Europe

Abstract

Rollover accidents seem to be a rising problem in Europe and therefore the systematic of this accident scenario should be investigated. Based on statistical investigations on major European accident databases for different countries a series of 73 real world rollover accidents was analysed. These cases were reconstructed using PC-Crash and preliminary categorised using a modified US-based rollover classification. In a first step, the rollover events were reconstructed from the point of conflict to the vehicle's rest position. The vehicles kinematics as well as its linear and rotational velocities were derived. In a second step typical velocity characteristics as well as kinematics were identified and the events categorised according to these criteria. Based on these results four main categories were defined, covering all reconstructed accidents. This categorisation was based on mechanical parameters (rotatory and translatory kinematical data of the vehicle). Significant differences can be seen for different scenarios for the "first phase of rollover".

Notation

Δv change in velocity due to an impact

φ roll angle

$\dot{\varphi}$ roll rate

Introduction

Rollover accidents are one scenario happening to passenger vehicles. This scenario was not investigated on an European level. Investigations mainly in the US have been done on this accident scenario and a classification based on these investigations was derived. For the US classification eight different scenarios are known by ASIC [1], based on typical sequences in the

case of rollover. This scenarios are: Trip-over – when the lateral motion of the vehicle is suddenly slowed or stopped inducing a rollover. The opposing force may be produced by a curb, pot-holes, or pavement dug into vehicle wheels. Flip-over – when the vehicle is rotated along its longitudinal axis by a ramp-like object such as a turned down guardrail or the back slope of a ditch. The vehicle may be in yaw when it comes in contact with a ramp-like object. Bounce-over – when a vehicle rebounds off a fixed object and overturns as a consequence. The rollover must occur in close proximity to the object from which it is deflected. Turn-over – when centrifugal forces from a sharp turn or vehicle rotation are resisted by normal surface friction (most common for vehicle with higher centre of gravity (COG)). The surface includes pavement surface and gravel, grass, dirt, etc. There is no furrowing or gouging at the point of impact. Note that if rotation and/or surface friction causes a trip, then the rollover is classified as a turn-over. Fall-over – when the surface on which the vehicle is traversing slopes downward in the direction of movement of the vehicle COG such that the COG becomes outboard of its wheels (Note: The distinction between this code and flip-over includes a negative slope.). Climb-over – when the vehicle climbs up and over a fixed object (e.g. guardrail, barrier) that is high enough to lift the vehicle completely off the ground. The vehicle must roll in the opposite side from which it approached the object. Collision with another vehicle – when an impact with another vehicle causes the rollover. The rollover must be the immediate result of the impact between the vehicles. For example, this could occur at an intersection where a vehicle is struck in the side and the momentum of the struck vehicle results in a rollover. End-over-end – when a vehicle rolls primarily about its lateral axis.

Based on this scenarios it was investigated, if they are applicable for European rollovers too. For choosing real world accidents for in-depth studies, basic studies of the statistics were analysed and resulted with the following characteristics for rollover accidents.

Statistical Analysis

SFERCO et al. [2] found out in the German In-Depth Accident Study (GIDAS) and the Co-operative Crash Injury Study (CCIS) in the UK had shown, that rollover count for 5-15% of all

accidents. Single rollover events, without any multiple impact are events in Europe up to 5% of all accidents. This is third of all rollover accidents. For multiple rollover accidents the first event is the impact rather the rollover. So a rollover can be regarded as a consequence of an impact rather than an initiator. Most vehicle rollovers involve one complete roll or less and they occur about the longitudinal axis of the vehicle, approximately half in each direction. When an impact follows an initial roll, it is frequently against a fixed object (rather than a vehicle) and appears to randomly involve all parts of the vehicle. In cases where rollover follows an initial impact, the impacts are split between those against cars and those against fixed objects. A disproportionate number of the initial impacts is against the sides of the vehicle that rolls over (rather than the fronts).

Analysis from the British national accident data (STATS 19) from KIRK [3] showed that 6% of all car casualties were injured in cars with an element of rollover and 12% for killed and severe injured car occupants (KSI). Of all cars that have a fatal occupant or occupants, 15.1% have an element of rollover. For cars that have an element of rollover, accidents that occur whilst negotiating a bend are far more common than for non-rollover cars, although overall normal going ahead accidents are most common. For cars that have an element of rollover, 77% are single vehicle events. For single vehicle crashes from crashes with another vehicle the most commonly vehicle struck is another car. Of all cars, 3.9% that have an injured occupant have a rollover and do not impact another vehicle. For cars with killed and severe injured occupants, frontal impacts are clearly the most common. A higher proportion of vehicles that have an element of rollover leave the carriageway, for KSI cars 81.9%. This also correlates with an increased proportion of objects hitting off the carriageway for cars with an element of rollover, for KSI, 67.7%. An increase in KSI rate is evident when the car leaves the carriageway. For cars with an element of rollover, the most commonly struck object off the carriageway is a tree followed by entering ditches. The most common car rollover accident scenario is for the vehicle not to impact any other vehicle or vehicles and to hit a fixed object off the carriageway and no object in the carriageway, accounting for 45.5% of all vehicles that have any element of rollover and an injured occupant. Of all severity rollover cars, 18.9% have no other vehicle

impact or any codeable impact with an object on or off the carriageway.

SFERCO et al. [4] were looking on differences of rollover data for US and Europe and it was shown that rollovers, as a single event (rollovers without the occurrence of any impact) are rare events in Europe. FAY [5] found that rollovers occur more frequently as a part of more complex accident sequences involving multiple impacts. In most of these multiple impact cases, the first event in the sequence is an impact rather than a rollover. In the US, rollovers have been identified as a significant safety issue, because a rollover crash is far more likely to result in fatalities than a non-rollover. Although only 3 percent of all passenger vehicles involved in crashes in 2000 experienced rollover, 20 percent of passenger vehicles involved in fatal crashes rolled. In particular, Sport Utility Vehicles (SUV), Multi Purpose Vehicles (MPV) and other light trucks are over-represented in rollover accidents.

Real World Accidents for In-Depth Studies

For this investigation a database containing about 150 real world passenger vehicle rollover accidents was used. The strategy for choosing these cases for in-depth studies is based on the results of the statistical investigations as well as the quality of documentation of the cases. These cases were reconstructed numerically using the accident reconstruction software tool PC-Crash [6].

Method

Relevant Mechanical Parameters

The PC-Crash reconstruction files of the reconstructions provided mechanical data on tire side forces of all four wheels, velocities in x-, y- and z-direction, the roll angle, the roll rate and the angular acceleration as these seemed to be of importance for detecting a rollover. After studying the provided data it seemed promising to further assess the importance of the roll rate for categorisation as it is used in state of the art technologies. For the general analysis it was focused on the roll rate and the roll angle as the relevant parameters.

This focus seemed plausible as a high roll rate at a low roll angle might not lead to a rollover whereas even a low roll rate at a large roll angle with the centre of gravity nearly above the wheels will cause

a rollover. There should be a direct interrelation between the parameters roll rate and roll angle and a rollover case.

In-depth Analysis of Relevant Cases

General Analysis from Point of Conflict to End of Rollover

The first step of analysing the PC-Crash data was to plot the roll rate [deg/s] as a function of the roll angle [deg]. As the different rollover cases analysed vary widely in their roll angle, the roll rate – roll angle graphs show very different patterns in the latter stages of the roll. The vehicle behaviour during the rolling phase (i.e. after the initial event) seems to happen at random.

As many graphs showed similarities at lower roll angles, the roll rate – roll angle graphs were plotted from the roll angle at the initial event ($\varphi_{t=0} = 0^\circ$) to a roll angle of $\varphi = 90^\circ$. This range also includes the relevant phase for detecting a possible rollover and for triggering possible safety systems.

When compared, groups of these graphs ($\varphi = 0^\circ$ K 90°) showed distinctive similarities and could be sorted into categories. The most obvious group is formed by cases with an impact. The graphs show distinctive differences between cases without impact or with impact.

Category 1: Rollover caused by some kind of impact (other vehicle, tree, or other)

The initial roll rate jumps to form a high peak and rapidly decreases afterwards before increasing again at roll angles of approximately 45° . If the impact is preceded by yawing and/or a sideways skid the graph may show a “γ”-form or encircle the centre of the coordinate system before it shows the characteristic mentioned above.

Category 2: Rollover caused by ramp like object (e.g. flat car, guard rail, slope)

The roll rate quickly rises to a high level but does not decrease as significantly afterwards as in category 1. The yaw angle remains at low levels (less than 30°).

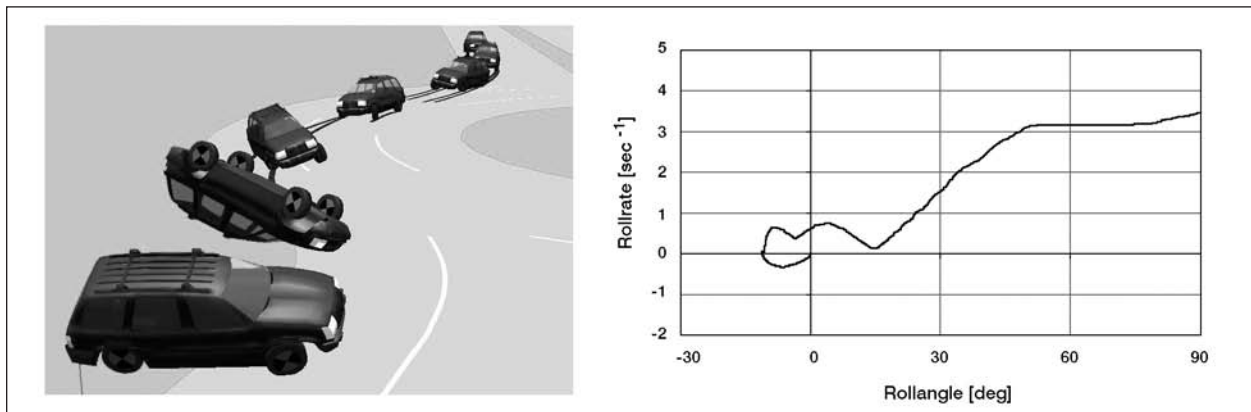

Fig. 1: Example for basic analyse of whole rollover event up to 90° roll angle

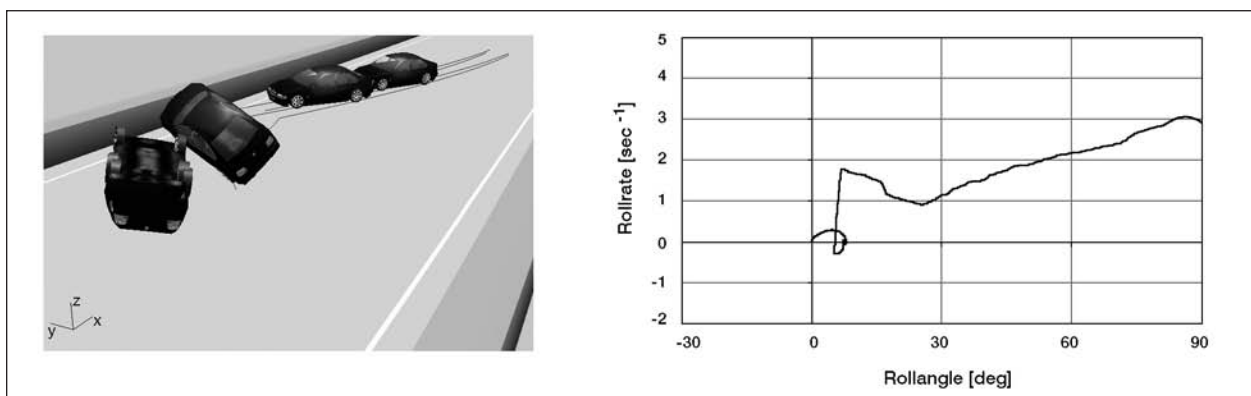

Fig. 2: Example for category 1

Category 3: Rollover caused by yawing and skidding sideways with vehicle being affected by a ditch or slope

The yaw angle at the start of the roll action differs widely (0° to over 200°) but on average seems to be lower than in category 4.

Category 4: Rollover caused by yawing and skidding sideways on an even surface
The roll rate builds up and the roll angle increases a little until it reaches a

constant value. The roll rate then decreases again as far as zero deg/s or below. When the vehicle starts to roll the roll rate rises to a high level. The graph shows a picture resembling the Greek letter " γ ". Due to strong yawing the graph may encircle the centre of the coordinate system. The increase in the roll rate is slower than in cases with impact. The yaw angle at the start of the roll action is mostly in the range between 70° and 90° .

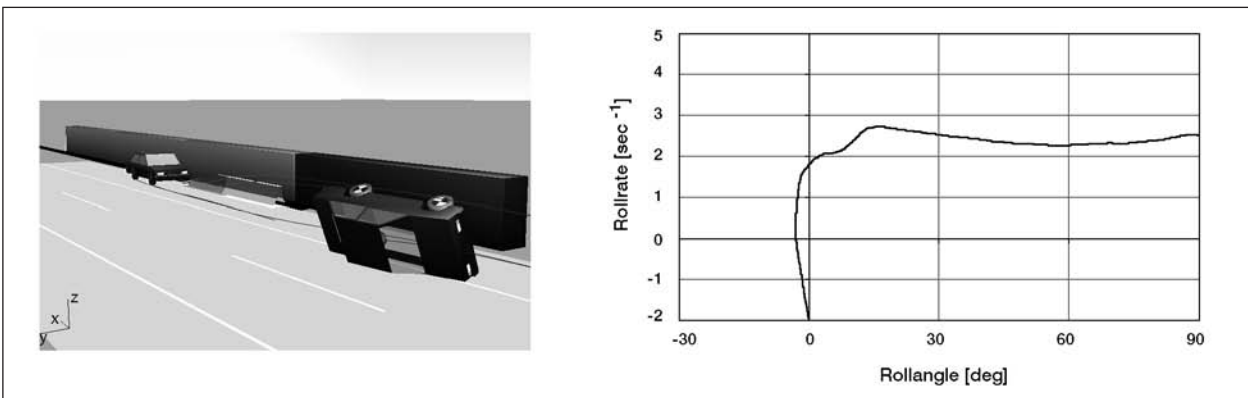

Fig. 3: Example for category 2

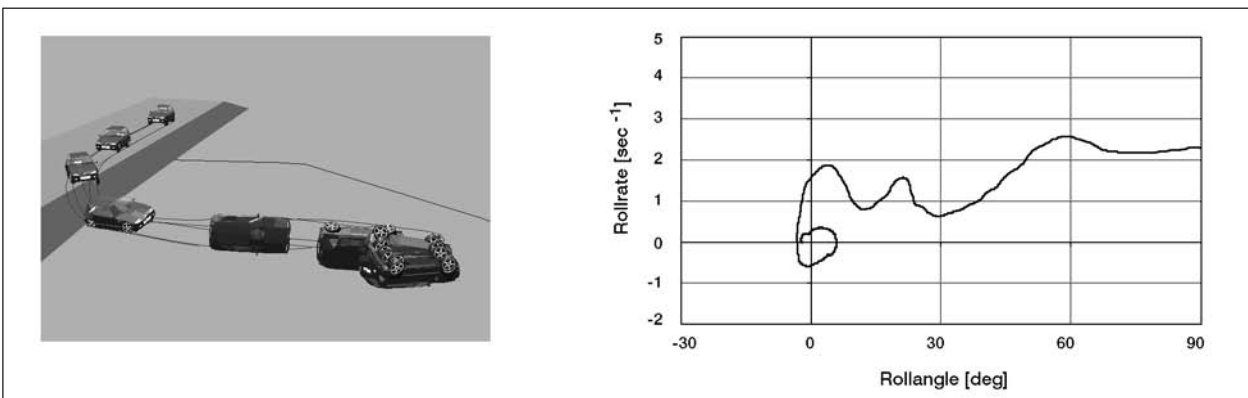

Fig. 4: Example for category 3

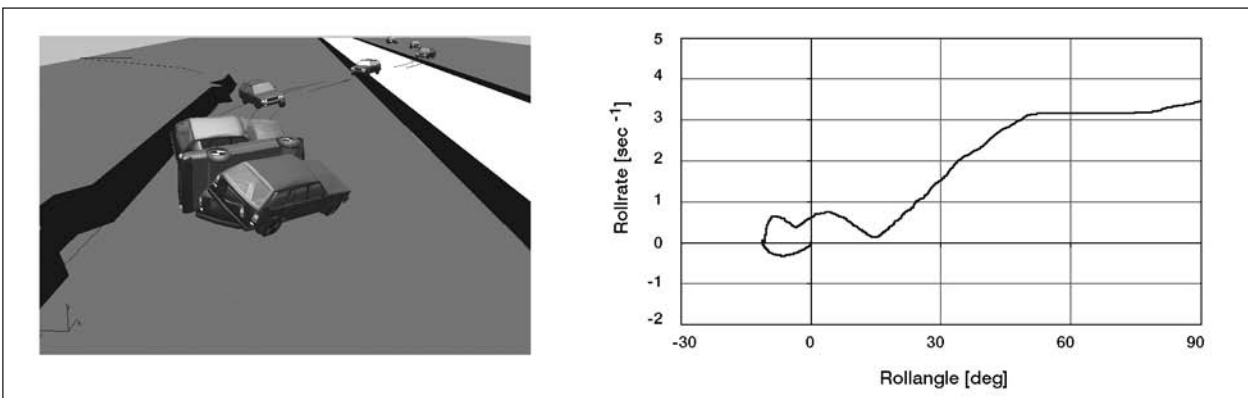

Fig. 5: Example for category 4

Category 5: Rollover caused by other causes

The graphs of pitch-overs show a very different characteristic in the roll rate
 → roll angle diagram which does not seem to be comparable to the previous cases

In-Depth Analysis for First Phase of Rollover

In a second phase the reconstructed cases were analysed from the start of the rollover (as described below) up to 90 degree roll angle. For this analysis the following time-depending mechanical parameters were available for the reconstructed cases:

Rotational motion: angle, angular velocity and angular acceleration for rolling, yawing and pitching (referenced to centre of gravity in a reference coordinate system)

Linear motion: linear movement, linear velocity and linear acceleration in x-, y-, z-direction (referenced to centre of gravity in a local coordinate system)

Additional: tire forces (side and normal)

For rollovers different parameters were analyzed on their characteristics over the roll angle. The following parameters show the most significant influence for categorisation for the first phase of rollover:

- o Roll rate vs. roll angle
- o Lateral velocity vs. roll angle (in a global coordinate system)
- o Longitudinal velocity vs. roll angle

Due to the long duration of a rollover the characteristic becomes more and more randomized if the whole rolling phase is used. So the rollover is divided into 4 phases (see figure 6):

1. Pre-roll phase
2. Point of no return
3. First phase of roll
4. Rolling phase

Pre-Roll Phase

The pre-roll phase is the phase when the vehicle is coming into a destabilized driving mode till the “point of no return” where the rollover cannot be avoided. In this phase active safety can be used to stabilize the vehicle and avoid exceeding the “point of no return”.

The more it seems to be unavoidable to stabilize the car passive safety devices can also be pre-activated in this phase. If possible estimation on the severity of the impending rollover should be done.

Point of no Return

This is not really a time point. It is more a short time interval when the rollover cannot be avoided and passive safety devices have to be activated to reduce the risk of injuries to occupants.

First Phase of Roll

The first phase of roll starts from the “point of no return” and covers approximately the first 90 degrees of roll angle. It ends with the first impact of the vehicle structure with the ground. The car can always be in contact with the ground or loose the contact (flying phase).

Rolling Phase

The rolling phase is the phase from the end of the first phase of roll until the vehicle's rest position. The most important parameter for this phase is the number of turns.

For the detailed analysis of the rollovers the first phase of roll was used and defined in a little

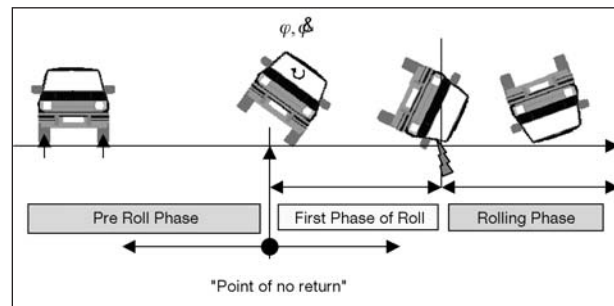

Fig. 6: Phases of a rollover

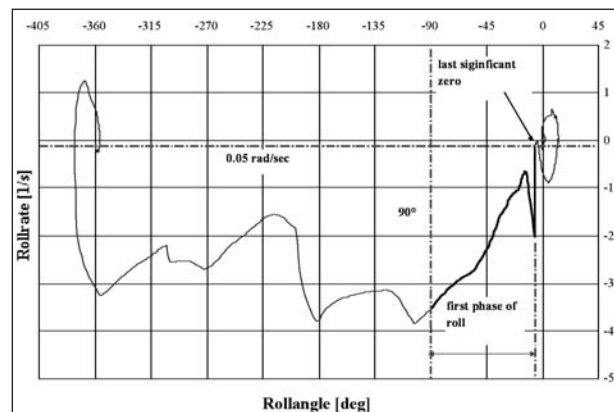

Fig. 7: Determination of first phase of rollover for a 360° left-side rollover

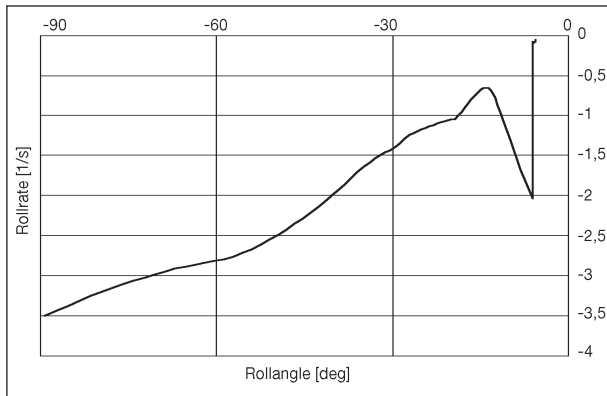

Fig. 8: First phase of rollover for a 360° left-side rollover

modified way. The start of this phase – the point of no return – was defined as last significant zero of the roll rate vs. the roll angle. Due to the numeric data a threshold for the zero of the roll rate of 0.05 rad/sec was used. For the end of the first phase of roll the 90 degree roll angle criteria was used due to the difficulties in finding the first impact in the rolling phase.

Results

Based on the procedure described all cases were analysed in detail for their significant roll angle – roll rate behaviour for the first phase of rollover. Also the longitudinal and lateral velocity characteristics were investigated and the following results were gained.

The main rollovers can be classified by the following categories:

- o Impact induced rollovers
 - o $\Delta v < 30\text{kph}$
 - o $\Delta v > 30\text{kph}$
- o Ramp-like object induced rollovers
- o Skidding and Yawing
 - o Trip induced rollover
 - o Turning and rollover
- o Others

Impact Induced Rollovers

Rollover accidents induced by any kind of impact (mostly with another vehicle but also with other object). This type of rollover scenario is divided into two sub-categories depending on the change of velocity (Δv) during the impact. For high Δv values

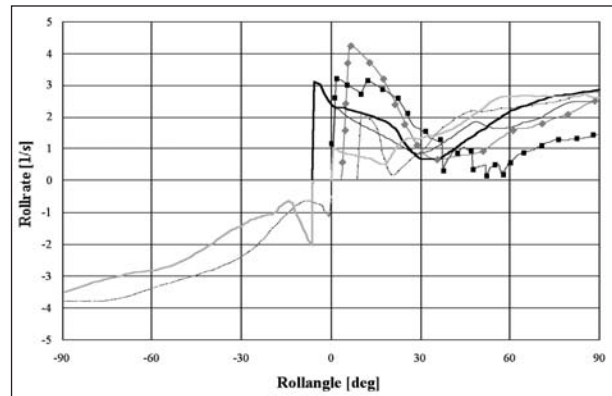

Fig. 9: Characteristics of rollover induced by an impact with $\Delta v < 30\text{kph}$ for different real world accidents

the impact inducing the rollover is considered as more harmful event than the following rollover.

$\Delta v < 30\text{kph}$

For this scenario the Δv for the rolling vehicle is less than 30kph. This is based on the analysis of the real world accidents. figure 9 shows the characteristics for this type of rollover. The initial roll rate jumps to form a high peak caused by the initial impact. For increasing roll-angles the roll-rate decreases fast and then increases moderate.

$\Delta v > 30\text{kph}$

Rollover accidents with an Δv higher than 30kph are considered to have a severe front or side impact. Therefore it is necessary to activate the passive safety system for this kind of impact. The following rollover is not as harmful as the initial impact.

Ramp-like Object Induced Rollovers

This type of rollover is induced by any kind of ramp-like object. This could be a guardrail, the end of a concrete barrier as well as an embankment, slope or the hood of an opposite car acts like a ramp. As can be seen in figure 10 the roll rate rises quickly to a high level and stays nearly constant for the increasing roll-angle. The analyse shows also that the longitudinal velocity is high and the lateral velocity is on a low level.

Skidding and Yawing - Trip Induced Rollover

This scenario happens when a car is tripping e.g. the tires are digging into gravel or soil. This is equal to a higher friction acting in the tire-ground contact and therefore a higher lateral force can be

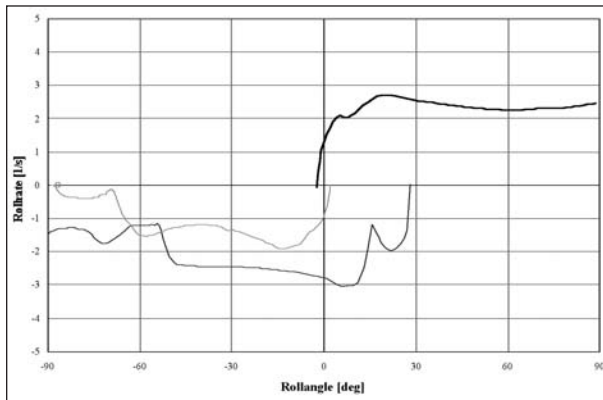

Fig. 10: Characteristics of rollover induced by ramp-like object

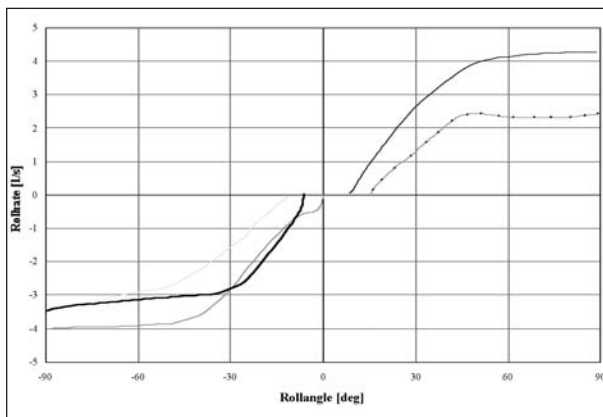

Fig. 11: Characteristics of a rollover induced by tripping

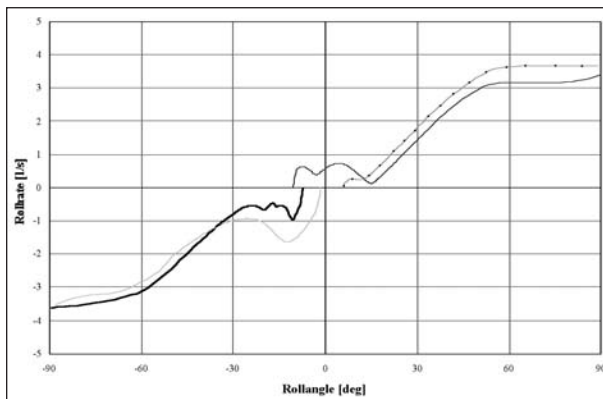

Fig. 12: Characteristics of a rollover induced by turning

obtained. figure 11 shows that the roll rate increase moderate to a constant value. The longitudinal velocity decreases to a constant value and the lateral velocity decreases rapid to a constant value.

Skidding and Yawing - Turning and Rollover

In this type of rollover the vehicle is normally driven on a ordinary surface. Due to the driven manoeuvres and the dynamic characteristics of the

vehicle the car gets into a unstable mode and a rollover results. The friction in the tire-ground contact is not increased as in case of tripping. Figure 12 shows that there is a significant initial oscillation in roll-rate caused by the unstable driving mode. The all over behaviour is the same like in case of a tripped rollover.

Others/Special Others

For the remaining rollovers its not easy to categorize them particularly as they are very rare events e.g. the end-over-end rollover, where the roll-axis is lateral. Some other special cases are the free fall of a vehicle e.g. down from a bridge or cases where the car is yawing and the back of the car is tripped when contacting the soil on the road side.

Discussion

The rollover cases chosen for reconstruction represent the statistical results from the survey laid out in the introduction as follows:

According to the STATS 19 77.3% of all rollovers are single vehicle events. From the 73 reconstructed cases 59 (81%) were single vehicle event cases which is the same proportion as found out by SFERCO et al. [2] and KIRK [3]. 43% of the reconstructed cases have an initial impact before the rollover which is a little less than FAY's [5] (58%) findings. In 12 reconstructed cases (16%) the vehicle impacts an object off the carriageway. According to KIRK this proportion is 46%.

In most rollover cases the vehicle turns around its longitudinal axis and makes 4/4 turns or less. The proportion of rolls to the right or to the left is half/half. Accordingly, of the reconstructed cases only 5 vehicles (7%) turned around their lateral axis. Of the others 49 vehicles turned 4/4 or less (67%). In 16 cases (22%) the vehicles turned more than one turn (5/4 to 30/4). For 7 cases it was not possible to account for the number of turns around the longitudinal axis as they were either pitch-overs or the reconstruction file did not give enough information. Of the vehicles turning around their longitudinal axis 32 turned to the right and 31 to the left.

According to GIDAS and CCIS analysis by SFERCO et al. [2] only around one third of all rollovers occur as single, isolated events in the UK

and Germany. The remainders occur during more complex multiple impact crash sequences. 43 of the reconstructed cases had no impact and can be regarded as single isolated events. This proportion (59%) is about twice as high as stated by Ford.

Conclusions

The rollover categorisation defined in this work can be used also by non-professional analysts for pre-categorisation of an accident. The rollover can be compared easily to the four main categories: impact induced, ramp-like object induced, skidding and yawing or others. When reconstructing a real world accident a final classification can be done when analysing the vehicle trajectory and its kinematical data. The selected real world accidents represent the statistical findings from other authors.

Acknowledgement

This study was performed within the project "Improvement of Rollover Safety for Passenger Vehicles" founded under the R&TD program "Growth" by the European Commission (www.mechanik.tu-graz.ac.at/rollover).

References

- 1 S. ASIC: Field Conditions Definitions - NASS-CDS Classification, Presentation, Delphi, European Community – R&TD-Project – 5th Framework-Programme "Growth" – Project "Rollover" G3RD-CT-2002-00802, 2002
- 2 R. SFERCO, P. FAY: Vehicle Rollover in Europe - A Real World Overview, Presentation, Ford Motor Company, European Community – R&TD-Project – 5th Framework-Programme "Growth" – Project "Rollover" G3RD-CT-2002-00802, 2003
- 3 A. KIRK: Great Britain Statistics, Report Work Package 1 – Task 1.1, Vehicle Safety Research Centre, European Community – R&TD-Project – 5th Framework-Programme "Growth" – Project "Rollover" G3RD-CT-2002-00802, 2003
- 4 R. SFERCO, P. FAY, S. ASIC: Comparison of US and European Rollover Data, Report Work Package 1 – Task 1.1, Ford Motor Company and Delphi, European Community – R&TD-Project – 5th Framework-Programme "Growth" – Project "Rollover" G3RD-CT-2002-00802, 2003
- 5 P. FAY, R. SFERCO, R. FRAMPTON: Vehicle Rollover - An Important Element in Multiple Impact Crashes, ESV 2003, Japan, 2003
- 6 PC-Crash User Manual: Dr. Steffan Datentechik Linz, Austria, 2003

J. M. Barrios, S. J. Busby, J. Huguet,
V. Salvachúa, G. Tejera
Applus+IDIADA, Tarragona, Spain

In-Depth Accident Investigation of Rollovers as a Basis for the Development of New Testing Procedures

Abstract

In-depth road traffic accident research in Spain is a fairly recent activity. In the past, only accident data that had been retrospectively processed by the national and regional traffic police forces was available. In 1999 Applus+IDIADA set up a permanent accident research unit to carry out in-depth analysis of road accidents in Spain. Since then accidents involving cars, motorcycles, coaches and vulnerable road users have been thoroughly studied. The Applus+IDIADA accident research team has carried out work for the various traffic polices in Spain and it is currently involved in several research projects in which accidentology is one of the main tasks. The working methodology of the team is presented in the first part of the paper.

In the framework of the European research project "Rollover" (GRD2-2001-50086), Applus+IDIADA has collected data, inspected scenarios and performed virtual reconstructions of twenty-six of the total seventy-six rollover accidents studied. The second half of the paper describes how these accident investigations were used to develop a test procedure for identifying possible improvements to the vehicle structure which augment occupant protection in a rollover scenario. In particular, a proposal for a new drop test for rollover assessment is presented. The cases were analysed for severity, in terms of injury to the occupants and damage to the vehicle, and taking into account whether a seatbelt was worn or not. The worst possible cases were identified as those that had severe occupant injuries and sizable damage to the occupant compartment when seatbelts had been worn. The most severe cases were then analysed further for impact position (roll and pitch angles) and the impact velocity. With these parameters taken into account, the most representative combinations could be found. This resulted in a series of configurations for possible drop tests. The

results of the tests indicate where passenger vehicle structures need to be improved in order to increase occupant safety in the event of a rollover crash.

Background

Vehicle safety development is completed through engineering and homologation. Safety developments are carried out through vehicle crashworthiness, restraint system integration and pedestrian protection assessment. Vehicles are tested for their crashworthiness in all directions of impacts. Restraint system testing and development are carried out according to the various standards using simulation techniques as a complementary tool to sled tests and full scale crashes. Pedestrian protection development and testing utilise free-flight and guided impact test devices to carry out physical simulations for the verification of virtual pedestrian crash simulations and calculations. At the final stage of vehicle safety development, the team dedicated to homologation ensures that engineering developments conform to the required standards (figure 1).

On the other hand, accident investigation forms the basis for the current test procedures for vehicle safety development. However, a number of factors such as improved crashworthiness of recent vehicles, widespread introduction of smart restraint systems and even significant changes in the vehicle fleet – for example, increasing presence of sport utility vehicles – makes it necessary to periodically review test procedures and to provide the appropriate feedback from real world conditions. This can only be done by means of accident research. This paper is concerned with accident analysis with the aim of acquiring

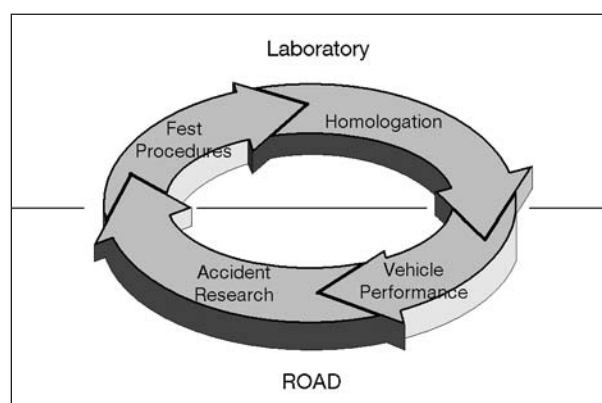

Fig. 1: The vehicle safety development process

enhanced vehicle safety development techniques for the particular typology of rollover accidents.

The Applus+IDIADA Accident Investigation Unit

Introduction

In 1999 a permanent accident research unit was set up to carry out in-depth analysis of road accidents in Spain. Since then accidents involving cars, motorcycles, coaches, lorries and vulnerable road users have been thoroughly studied. Applus+IDIADA collects data, inspects scenarios and performs virtual and physical reconstructions of accidents. The team consists of three full-time accident investigators working very closely with an experienced group of project engineers of different areas (homologation, active safety, passive safety, computer simulation). The working methodology of the Applus+IDIADA accident research team is conducted in a methodical and precise manner to ensure that all possible information has been obtained and used to carry out the most accurate of studies. The investigation stages consist of preparation, practical investigation, processing and analysing the results.

Up to now, the accident investigation unit has been working on specific research projects with the traffic authorities in Spain at local, regional and national level. In the period 2000-2001 Applus+IDIADA carried out at national level an in-depth study of 10 accidents in which buses and coaches were involved. This work was commissioned by the Spanish Home Office through the State Traffic Office. In the same way, since the setting up of the team Applus+IDIADA has conducted several accident reconstructions for both the Catalan Traffic Office (regional level) and City Council of Barcelona (local level).

Currently, Applus+IDIADA continues to work with the regional and local traffic authorities carrying out new accident reconstructions. In the same way, Applus+IDIADA acts as a consultant to the different traffic authorities in Spain either conducting specific studies or giving advice in the preparation of their road safety campaigns. On the other hand, Applus+IDIADA is currently taking part in two EC funded projects within the 5th Framework Programme ('Child' and 'Rollover'). Its contribution to these projects consists, among other tasks, of

accident data collection and physical and virtual accident reconstruction.

Set-up of Accident Investigation Projects

There are three main bodies involved in Applus+IDIADA accident studies; these are the accident investigation department, the traffic police and the local health care services and hospitals. With a mutual interest in reducing the number of road traffic accidents and injuries, resources are pooled to provide an accurate, detailed investigation; hence the completion of a precise reconstruction can be carried out.

At the beginning of a new project all of the associates that will be involved are informed. For this preparation a kick-off meeting is held with representatives of the involved divisions. Here the new project is outlined and discussed. The meeting is designed to inform the traffic police and healthcare services concerning the intentions of Applus+IDIADA in the project, to convey the general overview of the study and indicate to the other factions the information that will be required.

After the traffic police have investigated the scene of an accident and formalised their report, they select the case suitable for Applus+IDIADA studies based on the information and specifications of the project given in the meeting. The traffic police send a summary of the report, designed as a result of the meetings, to Applus+IDIADA technical centre. The accident investigation department analyses the accident with regards to the project criteria and makes the final decision on whether the case is appropriate. If the case is deemed to meet the criteria then a request for further information is made.

The information delivered comprises the police investigation into the accident and additional information specifically required by Applus+IDIADA. The police investigations can have varying levels of content depending on the circumstances of the accident but a typical file contains the following:

- Summary
- Description of the location
- The persons involved in the accident
- Interview extracts from driver/passengers/other
- Vehicle specifications

- Impact details – position
- Point of crash
- Trajectories before and after the point of impact
- Various Studies (these vary depending on the circumstances of the accident)
- Causes of the accident
- Various hypotheses for the accident
- Photographs of the scene of the accident and the vehicles involved
- A plan of the accident in the form of a step diagram

Practical Investigation Methodologies

The practical investigation is begun with a general vehicle investigation entailing the visual inspection of the vehicle – important characteristics are observed such as deformation, intrusion and restraint systems for their presence, use and their activation.

Observations precede general measurements of the vehicle. The general measurements provide an instant hard copy of information regarding the deformation. Examples of deformation and intrusion measurements recorded are: side sill reduction, wheel base reduction, A-pillar intrusion, foot well intrusion, maximum front and side deformation. These measurements are taken using an accurate laser distancemeter.

After the general over-viewing measurements have been recorded an accurate detailed study of the deformation is carried out using a theodolite to take numerous points at the impact position. Theodolites are instruments primarily used in trigonometric surveying: for the accurate measurement of horizontal and vertical angles. For accident reconstructions they are used to create a three-dimensional map of points in space for an accurate representation of objects and shapes.

The first measurements to be taken are the reference points. These are required to generate the system in which the points will be referred to. Once the reference has been defined the points are taken. A particular methodology is used for this in order to make processing the results easier. The points are taken in a particular sequence that follows the profile of the deformation being measured. The reasoning behind this is that when

the points are entered into the CAD software they are joined in the same consecutive sequence as they were taken. The sequence will therefore create a map in space that will outline the shape of the vehicle and visibly indicate the deformation. The deformed shape can therefore be entered into CAD software and compared with another vehicle of the same make and model to calculate the deformation. Finally, the forms defined by the project are filled to conclude the vehicle investigation.

The investigation of the scene is carried out in a manner comparable to the vehicle. Initially the crash scene is examined for indications as to where the point of impact and final rest position may have occurred. This entails finding distinct markings in the immediate surroundings of the accident, for example, marks left by the police on the road and vehicle fragments. Once the scenario has been established, the scene is quantified using the theodolite. The theodolite positioning is important here; it is located in such a way that it is possible to view the entire scene from a single point. When a satisfactory position has been obtained the points are taken. Measurements are then recorded at regular intervals along the road side starting with an initial reference point. This method creates points in space that represent the road plan when the points are joined, indicating relief and shape. The final part is to fill the forms defined by the project to conclude the scenario investigation.

As for the the occupants of the vehicles involved, if it is possible to contact them for further information they are interviewed in an objective manner following specifically designed questionnaires.

Processing of Data

The points that were recorded using the theodolite are processed into a format that is readable by CAD, using the tools contained in the software the vehicles and scenarios are rendered appropriately. The roadway file is imported into PC CRASH[®] for use in the virtual reconstruction. The deformed vehicle model is used for taking further accurate deformation measurements by a comparison with a non deformed model of the same type.

The complexity of PC CRASH[®] depends on the case. Reconstructions use the information and parameters gained from police reports, and from the inspections and analysis of measurements as a

basis. The investigation engineer uses experience and understanding of the case to identify the unknown parameters. In order to have an accurate reconstruction, any parameters that are selected are chosen for a reason.

Every step of the reconstruction can be analysed for numerous results and analysis. Examples are shown below; the two graphs indicate acceleration and velocity respectively after an oblique collision when two vehicles attempted to join the same path at the same time.

Reconstructions are used to establish a clear picture of the accident scenario and to make use of the data that the software formulates as a result of the inputs. The use of the data varies from project to project. For example on the one hand, in the European 'Rollover' project, Applus+IDIADA were to define a new test for structural analysis in case of rollover, this entailed developing the drop test. For this the roll and pitch impact positions were identified using the virtual simulations in PC CRASH®. On the other hand, for the European project 'Child', the kinematics of the vehicle and the occupants are important for any point in the accident sequence. One of the objectives of this project is to determine if the biomechanical behaviour of the child anthropomorphic dummies is representative of real children.

Different projects require the collection of different information, however, the general objective of such studies is to improve the protection for all road users, both occupants and pedestrians. In order to develop protection measures for occupants and pedestrians it is very important to obtain information on the injury mechanisms and hence the injuries. Applus+IDIADA gains this information from healthcare services and hospitals. The information provided is in terms of the scientific injury. Every feasible injury has been assigned a code on the Abbreviated Injury Scale (AIS). This facilitates understanding of the injury severity.

The accident investigation unit in association with the traffic police and the health care services and hospitals carries out investigations effectively and thoroughly in the development of safety for all road users in various projects on a local regional national and international scale.

Development of a New Drop Test Procedure within the 'Rollover' Project

Introduction

Applus+IDIADA has been engaged in the European 'Rollover' project (GRD2-2001-50086) since June 2002 and will continue to be involved until 2005. The overall aim of the project – a research activity within European Commission 5th Framework Programme – is to assist European sensor system developers and restraint and vehicle manufacturers to develop effective rollover protection systems in a cost effective manner. The project is a common effort of the following 16 partners: TUG, ESI Group, MIRA, TNO, TUV UVMV, MAGNA Steyr, LMU, Concept, GDV, Bolton Institute, Ford Renault, Delphi, TRW and Applus+IDIADA.

Applus+IDIADA has been involved in five of the six work packages in the project but largely, as work package leaders in one particular work package, associated with various aspects of rollover physical testing and development. The work package is divided into four subtasks: structural, interior, restraint and sensor developments. Applus+IDIADA are task leaders for structural testing and development within this work package, largely due to the specialised skills of the workforce in the field and the facilities available to carry out the tests.

Rollover accidents are complex situations to reproduce in a crash test laboratory. The nature of the accident itself, the unpredictable behaviour of the tyres and suspension systems – thus influencing the number of rolls – are difficult variables to control in a full-vehicle dynamic test. Currently, the only vehicle standard which includes a rollover condition – transversal rollover – is the American FMVSS 208 [1]. This test configuration however presents the problems mentioned above. An attempt to overcome these issues was made with the introduction of the inverted drop test procedure (SAE J996) [2]. This SAE recommended practice establishes a standardized test procedure to obtain as closely as possible deformation of a vehicle roof which occurs in a vehicle rollover. The procedure is intended to provide reliable and repeatable results and to permit valid comparisons between various vehicle models. Structural deformation from a drop test is more readily reproducible than the deformation from rollover tests due to extreme variations and the unpredictability of rollover tests.

Since one of the aims of the 'Rollover' project is to develop suitable test procedures for enhancing rollover protection, a proposal for a new drop test procedure is presented. This test procedure intends to update the test configuration of the SAE J996 protocol and is particularly addressed to the European vehicle fleet.

Data Collection and Processing

Applus+IDIADA began work in the project by acquiring the cases for the rollover project database. The work policy at Applus+IDIADA is to select new cases specifically for the project after it has been defined, rather than to have a database of cases from which appropriate cases are selected. This ensures that the specific data required for the current project is present and available and the cases are as up to date as possible and representative of the current vehicles on the road. Carrying out the research in this manner also ensures that the Applus+IDIADA's rollover research database will continue to expand. The process of accident investigation for the rollover project proceeded in the same methodical manner as usual.

The traffic police were informed regarding Applus+IDIADA's involvement in the new project and its aims through meetings. Applus+IDIADA specified the subjects of information that would be required for the project so that when the traffic police were next called to a rollover accident scenario, the specific information could be obtained. The accident summary and information was faxed to the Applus+IDIADA technical centre in Tarragona after the traffic police inspection. If the criteria defined by the rollover project were present the case was accepted. If accepted a further

request was made for the traffic police full report. With the information now available concerning the locations of the scene and the crash vehicle(s) Applus+IDIADA carried out a full investigation. During the inspections all the information specified by the project was gathered where possible. For example, all vehicle information: type, make, model, various deformations. All occupant information: number of, age, gender, seatbelt, injuries. All scenario information: what happened, how, where, what type, weather condition, time of day, etc.

When the 'Rollover' database was finalised there were seventy-six cases reconstructed of which Applus+IDIADA had completed twenty-six. The accident scenes and vehicles were inspected and quantified using the theodolite, the three dimensional maps indicated with points were transferred from data into an Auto CAD file where the maps were finalised to create a three-dimensional rendered visualisation of the scene and the vehicle(s). The Auto CAD file was imported into PC CRASH[®] for an accurate and detailed reconstruction. The screen shots below (figures 2a and 2b) provide an example of such a transformation.

The points taken for the crashed vehicle(s) were used to measure particular deformations and intrusions. The points are taken using the theodolite and transferred into the Auto CAD software. An example of the process is shown below (figure 3).

The required data files were transferred into the PC Crash[®] program and the reconstruction commenced. To begin with the basic parameters were input. For example: the car, make, model,



Figure 2

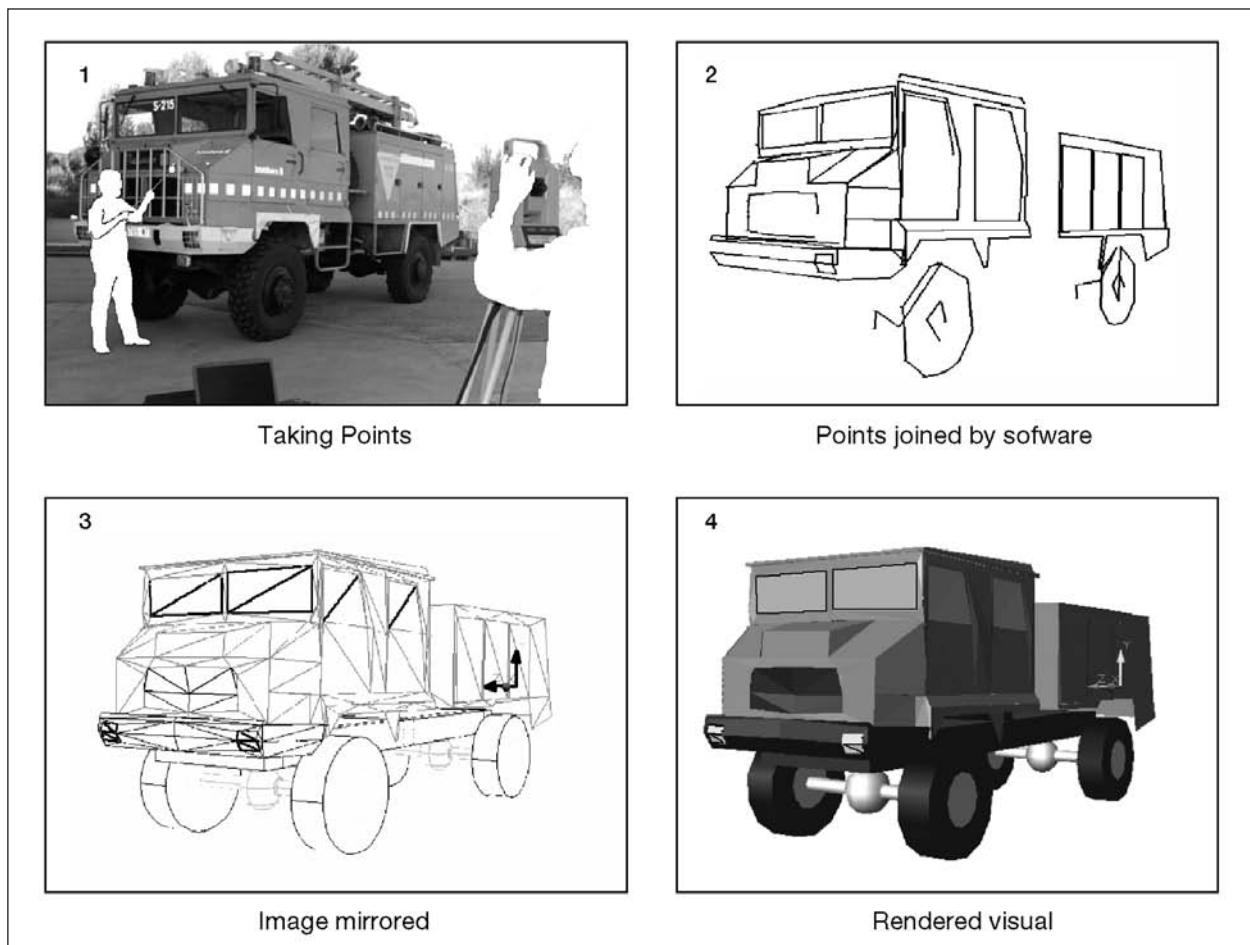

Fig. 3: Example of vehicle 3D-measurement process

settings and height of the centre of gravity and the number of passengers, the latter two being very important for rollover reconstruction. The sequences were defined after the basic parameters had been entered. These are the sequence of events that occurred during the accident based on the information obtained by the traffic police. For example, using the estimated velocities, the weather conditions and the sequenced diagram of events given in the report, the chain of actions was defined.

Once all the information available has been entered a preliminary simulation is initiated, this initial reconstruction may need to be modified to improve the accuracy. The engineer uses the numerous options and tools contained in the software and his experience in using this. For example, the vehicle may do too few or too many rollovers. The friction of the surface on which the vehicle is travelling greatly affects the rolling behaviour of the vehicle. Applus+IDIADA has researched the friction coefficients of several surfaces and therefore defined rules for applying some standard frictional

coefficients to a surface. Other variables can also be altered in order to render accurate results, these changes are required to have reasoning behind them to ensure the accurate representation of the real accident.

The simulations completed by the partners involved were submitted with all other data to the 'Rollover' project database.

Applus+IDIADA used the information and the reconstructions from the database for their next main role in the project – structural testing.

Research and Analysis

Structural testing began with researching current rollover test methodologies, analysing and evaluating them with respect to specific criteria, such as repeatability and representation of 'real world' accidents, defined by Applus+IDIADA. These criteria were based on the research and the views of the accident reconstruction engineers. The result of the research was the signifying of the

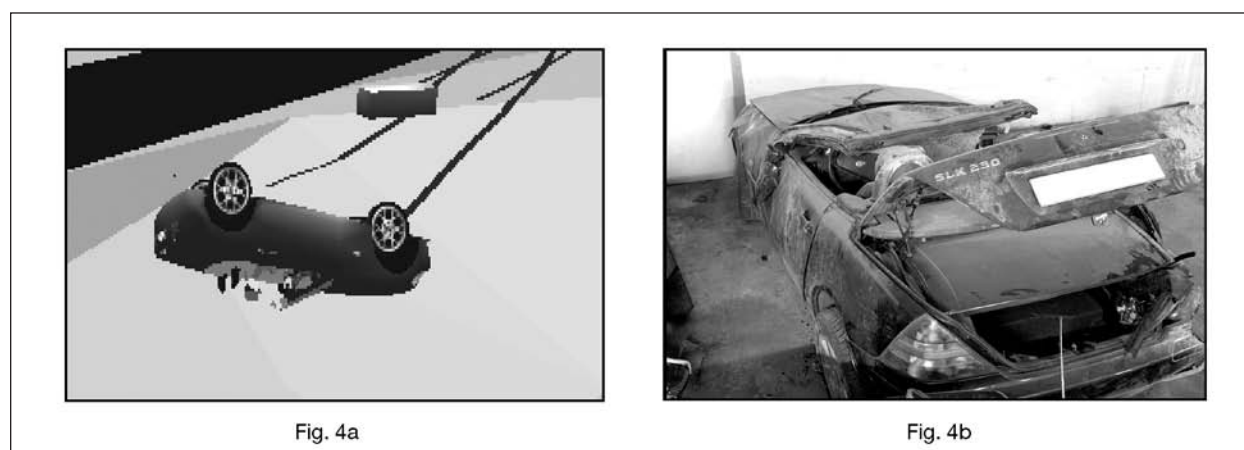

Figure 4

'Drop test' that met all the criteria set with the aim of investigating vehicle structures in the event of rollover.

The 'drop test' is a simple procedure and regarded as representative of 'real world' cases due to the flexibility of possible test configurations. The drop test was developed with the aim of increasing its representation of known 'real world' cases i.e. the cases in the 'Rollover' project database. This development involved deeper analysis of the cases using PC CRASH[®].

The 'Rollover' project database consisted of seventy-six PC CRASH[®] reconstructed cases when complete. However an initial development phase of the twenty-six Applus+IDIADA reconstructed cases was employed to make certain that the development of the seventy-six cases would reap useful results. The development was designed to systematically identify the most representative and severe Drop test roll and pitch angle configurations. The developments consisted of several stages:

The first consisted of summarising each of the accidents in the database, for example, what happened, how it happened and the consequences, by viewing the photos of the crashed vehicles and the AVI files created in PC CRASH[®].

The second stage involved in-depth use of PC CRASH[®] to indicate the actual impact positions in terms of roll and pitch angles (figures 4a and 4b). The reconstruction was run for each case and the results of the calculations generated by PC CRASH[®] were used to determine where the strongest impact position may have occurred. The

software tools gave the roll and pitch angles at these positions.

The third step of the development was to assess the cases with respect to certain characteristics. Essentially the worst cases needed to be identified. The aim of the characteristics was to filter out the 'less important' cases and concentrate on those that had the more serious consequences. The crash severity was indicated by stating if the crash resulted in:

- Serious occupant injury. Injury was defined as serious if the AIS was three or higher.
- Serious damage to occupant zone of the vehicle. Due to a lack of deformation data in the database this criterion was based on visual deformation from photographs. This was considered sufficient for the task in hand.

If these two criteria were characteristic of the case it was subjected to a further filter to determine the most serious cases. The final filter considered if the occupant in question was wearing a seatbelt or not at the time of the accident. If indeed the occupant was wearing a seatbelt then the case was classified as serious and was eligible for the final stage of the development. If not the case was excluded because it was not possible to determine whether the severity of the accident was a result of the rollover or the fact that the occupant was not wearing a seatbelt.

The strongest impact and the most severe accidents had now been defined. The development continued by assessing any correlation between impact position and injury severity. It was not possible to conclude this from the test development. The final cases that reached this

category were sparse and saw impact positions that were quite varied. This however did not deter analysing the accidents in this way, it simply confirmed that rollover accidents can be very different from one another and that the current protection for occupants in rollovers is on the whole not sufficient. Instead of using one configuration it was decided that two would be used in order to increase this representation.

Results

A total of 76 rollover cases were PC CRASH[®] reconstructed in the European project 'Rollover'. These cases were evaluated with regard to the impact angles and velocity in order to determine a test that represented the vast majority of the most serious rollover scenarios. The aim was to identify the most severe impact positions according to these 76 cases. The cases were analysed in four different ways:

- The first indicated the strongest impact position and showed the severity of the injury that resulted.
- The second used the same strongest impact position as before; however indicated the damage to the occupant compartment that resulted.
- The third used the same strongest impact position, this time indicating both injury and

damage to occupant compartment levels; they are not always mutually inclusive.

- A further stage was carried out to indicate if a seatbelt was being worn during the accident. If a severe injury and a high level of damage resulted from the accident and a seatbelt was worn by the occupant, then only the case qualified for a most serious case.

It turned out that in 16 of the 76 cases serious injuries – AIS3 or above – were present and the vehicles were seriously damaged, with large visible intrusions into the occupant compartment. These were identified as the most serious cases.

There were 4 cases that met the injury requirement to be included as serious, however the occupant compartment was not visibly intruded and there was no intrusion data on these cases. These cases were excluded from the study because the aim was to analyse the effect of the vehicle structure on the protection of the occupants.

The 13 most serious cases were then identified (table 1).

The table indicates that 5 of the 13 cases are from the category 'Impact induced rollover ($\Delta v > 30\text{kph}$)' this is therefore clearly the most serious mode of rollover crash. At the end of the table the average roll, pitch and resultant velocities are indicated. There are three averages given for pitch angle: the first is an average of all the most serious cases, the second is an average indicating the pitch in the

Case	Category	Roll [°]	Pitch [°]	Resultant Velocity [km/h]
1	Impact induced rollover $\Delta v < 30\text{kph}$	167	12	36
2	Impact induced rollover $\Delta v < 30\text{kph}$. Not usual cases	178	-26	40
3	Impact induced rollover $\Delta v < 30\text{kph}$. Not usual cases	138	21	1
4	Impact induced rollover ($\Delta v > 30\text{kph}$)	105 ¹	1	10
5	Impact induced rollover ($\Delta v > 30\text{kph}$)	125 ¹	3	32
6	Impact induced rollover ($\Delta v > 30\text{kph}$)	156 ¹	-1	6
7	Impact induced rollover ($\Delta v > 30\text{kph}$)	85	1	9
8	Impact induced rollover ($\Delta v > 30\text{kph}$)	146 ¹	6	12
9	Trip induced rollover	178 ¹	29	10
10	Turning and rollover. Not usual cases	172 ¹	-15	4
11	Special others: Free fall & Rear down tripped. Not usual cases	86	-2	25
12	Other	167	-14	23
13	Other	122	3	41
Average		140	10	19
			-10	

¹ For roll angles the direction has been omitted, the vehicle will be assumed symmetrical

Tab. 1: Selected cases for development of drop test procedure

positive direction according to the coordinate system and the third in the negative direction.

- The average roll, 140° only represents (±10°) 15% of the cases.
- The average pitch angles 10° and -10° represent (±10°) 85% of the cases.
- The resultant velocity average 19km/h represents (±5km/h) 8% of the cases.

The individual pitch angles seem to be very representative of these most serious cases. If two roll angles are selected in a similar way more representative results may be identified. By dividing the most serious cases into two roll orientations, 130° and 170°, the representation can be increased to 62%. In conclusion, two drop test configurations are proposed (figure 5).

These roll and pitch angles were then compared with all the cases with necessary information available. For the results, the cases where

important data was absent were excluded reducing the field form 76 to 54. The results showed the following:

- 100% of all cases had at least one of the suggested roll or pitch angles.
- 91% of the cases were represented by the pitch angles 10° and -10°. This figure was 81% for the most serious cases.
- 60% of the cases were represented by the roll angles 130° and 170°. This figure was 62% for the most serious cases.
- Approximately 50% of all the cases and the most serious cases were represented by either of the two suggested configurations.

Throughout the 76 cases the pitch angles did not vary a great deal, this was the main reason as to why the derived general result for pitch is so very typical of all the cases. The derived roll angles on the other hand were much less representative of

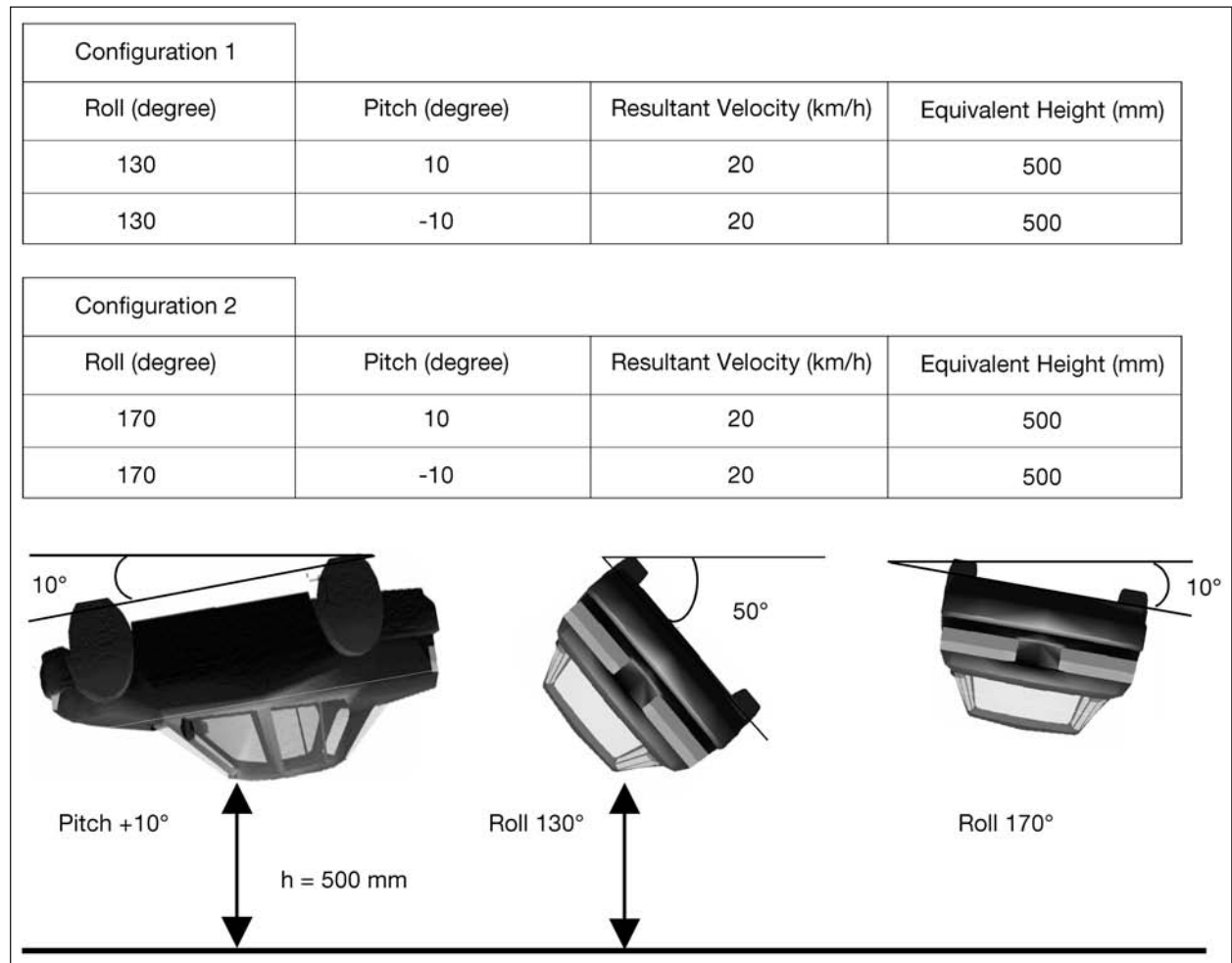

Fig. 5: Proposed drop test configuration

the cases, however they did cover 60% of the cases which indicates that their representation is significant.

If the derived roll and impact angles were both taken into account, then there was a total of four test configurations. These four tests represented approximately 50% of the cases. This is high enough to say that the representation is good.

The roll and pitch angles were determined by the most serious cases, there were no other combinations that could represent the most serious cases any better. It has been shown that these characteristics are represented in all the cases in a similar manner. A satisfactory level of representation has been achieved for a crash situation that can be individual.

The relative considerations that will make an effective test were found to be the following:

- **Repeatability:** the test is very controlled, roll and pitch angles can be coupled for any orientation, this means that very specific aspects of the vehicle structure can be loaded time after time in a test. This will make it possible to define a series of tests to gain an overall picture of vehicle structural integrity. This key factor is of utmost importance when testing vehicle structures for rollover protection. A repeatable test would enable the creation of an accurate model on which the development of safer vehicles in a rollover scenario can begin.
- **Representativity:** the test is controlled as mentioned previously, but the test still allows for a realistic representation of a rollover crash in that the vehicle can actually be dropped on its roof from whatever aspect or height deemed necessary. This will essentially represent a wide range of the worst cases, simulating impacts in real crashes.
- **Insensitivity to vehicle size:** vehicles of different sizes vary in dynamic behaviour when rolling. For example two vehicles of differing size would behave very differently in certain tests where there are rotational and/or translation movements. For example, FMVSS208 and corkscrew, this is due to the height of the centre of gravity of the vehicle. A higher centre of gravity will tend towards greater risk of roll. In the drop test there is essentially only one direction of movement and so the effect of centre of gravity is minimised. This is important

to create a standard which can be applied to all vehicles within reason. For example, all passenger vehicles, from small cars to Multi Passenger Vehicles and 4X4 vehicles.

Conclusion

Applus+IDIADA's task for the 'Rollover' project comprised the development of the drop test through virtual reconstruction of a group of representative rollover accidents. The development included the definition of new roll and pitch angles and also the height from which to drop the vehicle to represent the velocity of impact. Two drop test configurations are proposed with roll angle, pitch angle and height being 170° (10°), ±10° and 500mm for the first one and 130° (50°), ±10° and 500mm for the second one respectively.

The resulting combinations of these angles and height represent two thirds of the 'worst' cases in the 'Rollover' project database. They also represent two thirds of all of the seventy six cases involved in the project. The proposed test procedure combines good repeatability, reproducibility and insensitivity to vehicle size.

References

- [1] 571.208 Standard No. 208; Occupant Crash Protection
- [2] Inverted Vehicle Drop Test Procedure – SAE J996 JUN80. SAE Recommended Practice

U. Grömping, U. Weimann
Ford Werke AG, Köln, Germany

S. Menzler
Tierärztliche Hochschule Hannover, Institut für
Biometrie, Epidemiologie und
Informationsverarbeitung, Hannover, Germany

Split-Register Study: A New Method for Estimating the Impact of Rare Exposure on Population Accident Risk Based on Accident Register Data

Abstract

The data situation for quantifying the proportion of accidents avoided by the introduction of active safety systems is incomplete, since there is generally no data available on the accidents avoided by the technology in question. In this paper, a split-register approach is suggested and compared with the classical case-control approach known from epidemiologic applications. Provided a set of assumptions hold, which can reasonably be made in such data situations, the split register approach allows inferences on the population accident risk. For both approaches the benefits of basing the analysis on the results of a logistic regression to adjust for confounding factors are outlined. The biasing effects of violating key assumptions are discussed and the split-register approach is demonstrated using the example of the active safety system ESP with data from the German in-depth accident study GIDAS.

Notation

- A accident register vehicles
- D accident type that is suspected to be preventable by technology, e.g. loss of stability accidents
- \bar{D} other accidents (e.g. accidents where loss of stability played no role)
- E vehicles equipped with active safety technology of interest, e.g. ESP
- \bar{E} vehicles without active safety technology of interest, e.g. without ESP

x covariates

$P(D|E)$ probability of event D given event E

OR odds ratio

RR relative risk

Introduction

For investigations with the aim of quantifying the proportion of accidents avoided by active safety technologies like ESP, the researcher is confronted with an incomplete data situation. Since there is generally no data available on avoided accidents, conclusions usually have to be drawn from accident register, and possibly additionally population census data.

One way to deal with this data situation is to use the case-control approach, which is well known from epidemiology, where it was initially introduced for investigating rare diseases with long time of onset. In accident research concerned with quantifying the proportion of accidents preventable by introducing or promoting a certain active safety technology, there is a further difficulty. In addition to the accidents of interest possibly but not necessarily being rare, the exposure, which in this case would be a hopefully beneficial active safety technology, is often rare as well at the time of its investigation as a new technology. In this paper, an alternative approach called split-register is suggested for accident research based on accident registers (=accident databases), which is better suited for situations with rare exposures. Furthermore, it allows inferences on the population accident risk, which is not directly possible with the classical case-control approach.

In both approaches, logistic regression can be applied to adjust for confounding from third factors. The benefits and reasoning of this approach are briefly discussed in this paper.

The effect of violation of assumptions on the estimates is discussed and finally the split-register approach is demonstrated on the example of the active safety technology ESP with data from the German in-depth accident study GIDAS.

Analysis Approaches

Data Situation

Consider the population “all vehicles”, which are all vehicles registered in a certain region in a certain

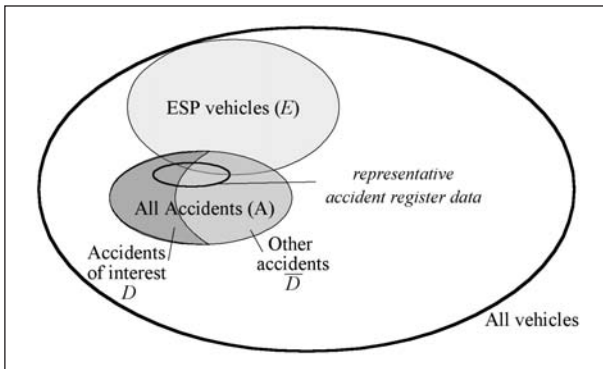

Fig. 1: Graphical illustration of example data situation

time frame. In this population of all vehicles, there is a subset of those vehicles E , which are equipped with the active safety technology of interest, e.g. ESP. The negation of an event is denoted by a bar, so all vehicles not equipped with the technology of interest are denoted by \bar{E} . Another subset in the population of all vehicles are those vehicles that have been involved in an accident and are registered in the accident register – this is not equivalent to the subset of all vehicles involved in an accident, because not all accidents are registered. The vehicles registered in the accident register can be partitioned into those vehicles D , which were involved in the accident type that is assumed to be preventable by the technology of interest, for example loss-of-stability accidents in case of ESP, and those which were involved in other accidents \bar{D} . In the following, the accidents which are assumed to be preventable by the technology of interest will be referred to as the accidents of interest (figure 1).

The Case Control Approach

In accident analysis, case control studies are studies in which vehicles which were involved in accidents of interest (cases) are compared with other vehicles (controls). The idea behind including controls in the analysis is that they can be used to estimate the exposure rate to be expected, if no association between equipment with the technology and the rate of accidents of interest were present.

The selection of cases and controls has to be independent of the exposure status, which in this case is whether the vehicle is equipped with the active safety technology of interest, see figure 2. For selecting the cases, the definition what constitutes an accident of interest has to be clearly understood. If not all the cases available are

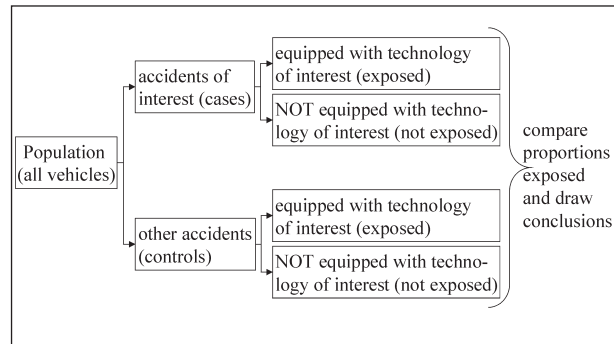

Fig. 2: Schematic of case control approach

selected for the study, then the study cases should be selected so that they are representative of all cases.

The controls should come from the same population at risk for the accidents of interest as the cases. They should be representative of the target population, or appropriate weighting factors for later analysis should be known. In order to avoid so-called confounding bias, sometimes the controls are chosen so that they match the cases with respect to other variables called covariates which might influence the rate of accidents of interest. This approach leads to less vehicles being included in the study and therefore less confidence in the results. If not all confounding variables are considered in matching, or if no matching has been carried out, a logistic regression can be applied prior to further analysis of results, to adjust for covariates.

The criteria for selecting cases in the context of this paper depend on the definition of what constitutes an accident of interest. In the ESP example the accidents of interest would be all loss of stability accidents and a clear definition of how accidents are classified into loss of stability accidents and other accidents is necessary. For the controls, there are several possibilities of setting selection rules. However, selection into the control group must not depend on presence or absence of the exposure.

There are case-control studies in accident research, in which the controls are recruited from non-accident vehicles, e.g. by randomly selecting license holders who live in the same geographical area as the cases [1]. Many case-control studies are register-based, however. They use certain accident types as cases, other accident types as controls [2, 3], in the example this could for example be all accidents D or a subset of D .

Because there is no absolute information on prevented accidents, only a relative estimate of the proportion of prevented accidents can be made. In the case control approach, the odds ratio can be used to do this.

With the odds of having an accident of interest given the exposure and covariates

$$odds_D | E = \frac{P(D | E, \mathbf{x})}{1 - P(D | E, \mathbf{x})} \quad (1)$$

and the odds of having an accident of interest given that the vehicle was not equipped with the technology of interest and covariates

$$odds_D | \bar{E} = \frac{P(D | \bar{E}, \mathbf{x})}{1 - P(D | \bar{E}, \mathbf{x})} \quad (2)$$

the odds ratio is given by

$$OR_D = \frac{odds_D | E}{odds_D | \bar{E}} = \frac{P(D | E, \mathbf{x}) / (1 - P(D | E, \mathbf{x}))}{P(D | \bar{E}, \mathbf{x}) / (1 - P(D | \bar{E}, \mathbf{x}))} \quad (3)$$

The odds ratio is the factor, by which the odds of having an accident of interest with an “unexposed vehicle” is multiplied to find the odds for an “exposed” vehicle. In this context, exposure means being equipped with the active safety technology of interest.

If the exposure has no influence on the odds of having an accident of interest, the odds ratio is equal to one. If the proportion of accidents of interest is smaller for vehicles equipped with the technology of interest than for other vehicles, which indicates the desired preventative effect of the technology, then the odds ratio is smaller than one. If this proportion is larger for the “exposed” than the “unexposed” vehicles, then a harmful effect of the technology is indicated and the odds ratio is larger than one.

The main advantage of the case control approach in the case of accident register data is that the analysis can be performed without the need to collect further data. Disadvantages of the case-control approach include the high bias risks, in particular selection bias for controls and confounding bias, and that only the odds ratio, but not the absolute reduction in risk can be estimated.

The Split-Register Approach

As mentioned above, one possibility to select cases and controls for the case control approach is

to use all vehicles from D as cases, and all vehicles from \bar{D} as controls. In the split-register approach, the same groups are determined.

In this case, the “cases” and the “controls” put together make up the whole population of accident register vehicles. This is very useful, if this accident register can be assumed to be representative for all accidents in a population of vehicles.

With the further assumption, that given the covariate information \mathbf{x} , the probability of causing accidents of the type \bar{D} (the control group or “other accidents”) does not depend on the fact whether the vehicle is equipped with the active safety technology of interest,

$$P(\bar{D} | E, \mathbf{x}) = P(\bar{D} | \bar{E}, \mathbf{x}) = P(\bar{D} | \mathbf{x}), \quad (4)$$

the odds ratio from the accident database coincides with the relative risk in the population.

The relative risk of accidents of interest for vehicles with vs. vehicles without the active safety technology of interest in the population is given by

$$RR_D = \frac{P(D | E, \mathbf{x})}{P(D | \bar{E}, \mathbf{x})} \quad (5)$$

It measures the risk of having an accident of interest in a vehicle equipped with the active safety technology of interest, compared to one not equipped with it, given covariates \mathbf{x} .

Often (4) is a reasonable assumption to make. In the ESP example, the accidents of interest are loss of stability accidents. The group of other accidents includes for example parking accidents or accidents that do not involve any yaw motion of the vehicle at all. For those “other accidents” it is reasonable to assume that equipping vehicles with ESP has no influence on the probability of their occurrence.

In the split-register approach, the analysis explicitly acknowledges that all information is conditional on the fact that an accident has happened. Thus, the probabilities $P(D | E, \mathbf{x})$ and $P(D | \bar{E}, \mathbf{x})$ cannot be directly estimated. Instead, the accident register yields estimates for the probabilities $P(D | E, \mathbf{x}, A)$ and $P(D | \bar{E}, \mathbf{x}, A)$, and in analogy to (3) an odds ratio $OR_D | A$ can be defined as

$$OR_D | A = \frac{P(D | E, \mathbf{x}, A) / (1 - P(D | E, \mathbf{x}, A))}{P(D | \bar{E}, \mathbf{x}, A) / (1 - P(D | \bar{E}, \mathbf{x}, A))} \quad (6)$$

Even though this model is conditional on the fact that an accident has happened, it can be shown that the unconditional relative risk (5) of having an accident of interest is equal to the conditional odds ratio (6), see appendix A.

This is a very useful result, because the quantity one minus the relative risk can be interpreted as the proportion of accidents of interest among those vehicles not equipped with the active safety technology that can be prevented by equipping them with it.

The quantity of interest in most investigations is the avoidable proportion of all accidents rather than the avoidable proportion of the accidents of interest D only. It is given by

$$1 - RR_{A,x} = P(D | \bar{E}, x, A)(1 - RR_D), \quad (7)$$

where the equality is shown in appendix A. In a split-register study, this quantity can be estimated for given combinations of covariates, provided assumption (4) holds. Logistic regression is a necessary first step to obtain this estimate.

An advantage of the split-register approach, as well as of the case control approach, is that application is simple and fast, if data are already available. Additionally, the relative risk and population risk can be estimated.

A disadvantage of the split-register approach, as well as of the case control approach is the high bias risk, in particular confounding bias which causes violation of the key assumption (4). Consequences of such a violation of assumptions is discussed further below.

Logistic Regression

Many researchers restrict attention to specific subsets of vehicles, in order to make exposed and unexposed vehicles (e.g. ESP and non-ESP) as comparable as possible. Consequently, only small numbers of vehicles are usable in the analysis.

Alternatively, all vehicles can be used. The important confounding information then has to be incorporated via a logistic regression. For example, in addition to ESP as the exposure of main interest, the power of the vehicle, vehicle equipment like ABS, power steering, the tire profile, weather and light conditions during the accident, the driver's age, gender, blood alcohol level can be adjusted for by carrying out a logistic regression.

Logistic regression is a standard technique implemented in statistics software packages like SAS, Minitab, SPSS or S-plus. It is a method for modeling probabilities of an event depending on other variables. For example, logistic regression can be applied for modeling the probability that an accident from A belongs to the accidents of interest D; as mentioned above, it would be desirable to incorporate information on exposure and further covariates, which can be done in logistic regression, similar to a linear regression approach. Since probabilities have to lie between 0 and 1, it is helpful to apply a transformation that allows using a linear function for modeling without running the risk of getting implausible values for the probabilities. The most commonly chosen transformation is the so-called logit-transformation that is the natural log of $p/(1-p)$ with p denoting the probability. The probabilities $P(D|\bar{E}, x, A)$ and $P(D|E, x, A)$ would for example be modeled by modeling their logits with a coefficient for the presence or absence of exposure and a linear function in x with coefficients to be estimated in order to achieve a good fit between data and model. It is a nice feature of logistic regression that the coefficients have an interpretation as logarithms of odds ratios. For further reference, see for example [6, 7].

Bias Investigation

In the section on the split register approach, it was shown, that the population accident risk reduction following from introduction of an active safety technology to all vehicles can be estimated. This only holds under the key assumption (4), that the probability of having an accident of type \bar{D} , a "control type" accident, is not influenced by presence of the technology under investigation. In this section, consequences of violations of this key assumption are discussed.

The most natural violation of this assumption is that some accidents which belong to D were wrongly allocated to \bar{D} . In this case, the presence or absence of the active safety technology of interest has an influence on the probability of \bar{D} , which is a violation of assumption (4). For a preventive exposure (e.g. ESP), i.e. if E has a beneficial influence on the accidents wrongly allocated to \bar{D} , then this leads to a dilution of the estimated impact of the exposure, i.e. the beneficial effect of the technology under

investigation is underestimated. Thus, although it is very desirable to avoid diluting study results, a wrong allocation of some accident types does not invalidate a proven benefit of a new technology.

If assumption (4) is violated the other way round, i.e. if exposure increases the probability of \bar{D} , then the benefit of the technology under investigation is overestimated. This violation may for example arise, if more risk prone customers buy vehicles with the technology in question so that their risk proneness increases their risk of having an accident that cannot be prevented by the technology. This bias can be mitigated by including variables in the logistic regression model that may account for risk proneness of the drivers, for example power of the vehicle or gender of driver.

Example: Quantifying the Effectiveness of ESP to Prevent Loss of Stability Accidents Based on GIDAS Data

The example is based on GIDAS data from 1994 to the middle of 2003, which is assumed to be representative for the accident situation in the area of Germany, where the data is collected for that period of time. For further information on data collection methods in the GIDAS study, see <http://www.gidas.org/>. In order to ensure independence between the different vehicles in the analysis, only one vehicle per accident was included in the analysis. The population of accidents in the register is partitioned into loss of stability accidents D and other accidents \bar{D} . The exposure in this case is whether the vehicle was equipped with ESP (E) or not (\bar{E}). The definition, whether an accident was a loss of stability accident, was based on information independent of whether the vehicle was equipped with ESP. The classification of the accidents depended on the accident type, driving speed, road condition, and

whether the driver stated he made an evasive manoeuvre. By this procedure, 48.47% of all accidents were classified as loss of stability accidents.

The total proportion of vehicles equipped with ESP were 2.72%, the first accidents involving vehicles equipped with ESP occurred in the year 2000.

A large number of variables that could possibly affect the probability of causing a loss of stability accident was considered in the logistic regression.

Logistic regression can only be carried out with vehicles for which there is a value for every variable that is to be included in the model. Only 1631 of the 6211 vehicles had complete information for all variables considered in logistic regression, and to only use those 1631 vehicles would have meant a considerable loss of information. Therefore a missing value imputation algorithm has been used to fill missing variables, see [4,5].

Twelve variables were found to have significant influence on the probability of causing a loss of stability accident and were included in the logistic regression model, so that they could be adjusted for when calculating the odds ratio.

The adjusted odds ratio is estimated to be

$$\text{est}(\text{OR}_D|A) = \text{est}(\text{RR}_D) = 0.5587,$$

i.e. $\text{est}(1 - \text{RR}_D) = 44.13\%$ is the proportion of loss of stability accidents among non-ESP vehicles that can be avoided by equipping all these vehicles with ESP. This result holds regardless of the covariate scenario.

Since the proportion of loss of stability accidents in all accidents crucially depends on the covariates, the covariates need to be taken into account for estimating the proportion of all accidents (A) that can be prevented. An overview of some scenarios is given in table 1.

	scenario 1	scenario 2	scenario 3	scenario 4	scenario 5
age of driver	18	38	38	38	60
passengers	yes	no	no	yes	no
tread depth	2	5	5	5	8
rain	yes	no	yes	no	no
day/night time	night	day	day	day	day
estimated accident avoidance potential of ESP installation	35.6%	21.3%	26.3%	19.0%	12.5%

Tab. 1: Estimated accident avoidance potential of ESP installation for several combinations of covariates

For a young driver with passengers in the car and worn tires with tread depth of only 2mm, on a rainy night, a vehicle equipped with ESP has an estimated accident avoidance potential of 35.6%. To the other extreme, for a vehicle equipped with tires with tread depth of 8mm, driven by a driver aged 60 without any passengers on a dry day, the estimated accident avoidance potential is only 12.5%. For an average age driver of 38 years, with passenger and tires with average tread depth of 5mm, on a dry day, the estimated accident avoidance potential of ESP is 19%.

Conclusions

Split-register-studies offer an interesting possibility of being able to estimate population relative risks in accident research. They are similar to case-control studies in many respects, especially the risk of confounding bias. They differ from case-control studies in that they are better for rare exposures like very new technologies and have a more sound line of mathematical arguments that allows direct conclusions on the population. They are a recommended strategy because of their simplicity and should be used in combination with logistic regression, in order to avoid confounding bias as much as possible.

References

- 1 C. TURNER, R. McCLURE: Quantifying the Role of Risk-Taking Behaviour in Causation of Serious Road Crash-Related Injury. *Accident Analysis and Prevention* 36 (3), 383–389, 2004
- 2 T. RUEDA-DOMINGO, P. LARDELLI-CLARET, J. D. LUNA-DEL-CASTILLO, J. J. JIMÉNEZ-MOLEÓN, M. GARCÍA-MARTÍN, A. BUENO-CAVANILLAS: The Influence of Passengers on the Risk of the Driver Causing a Car Collision in Spain– Analysis of Collisions from 1990 to 1999. *Accident Analysis and Prevention* 36 (3), 481–489, 2004
- 3 K. K. W. YAU: Risk Factors Affecting the Severity of Single Vehicle Traffic Accidents in Hong Kong. *Accident Analysis and Prevention* 36 (3), 333–340, 2004
- 4 S. OTTO: Quantifizierung des Einflusses aktiver Sicherheitssysteme auf die Unfallwahrscheinlichkeit und Identifikation von sicherheitsrelevanten Attributen basierend auf Realunfall-
- daten. Diplomarbeit, Fachbereich Statistik, Universität Dortmund, Germany, 2004
- 5 SAS Institute Inc. SAS/STAT[®] Software: Changes and Enhancements, Release 8.2. SAS Institute Inc., Cary, NC, 2001
- 6 A. J. DOBSON: Introduction to Generalized Linear Models, Second Edition, Chapman & Hall, 2001
- 7 D. W. HOSMER, S. LEMESHOW: Applied Logistic Regression, John Wiley & Sons Inc., 1989

Appendix A: Equality of Odds Ratio and Relative Risk in Split-Register Approach

Equation (4) means that the probability of causing accidents of the type \bar{D} , the control group or “other accidents”, does not depend on the fact whether the vehicle is equipped with the active safety technology of interest, given the covariate information x .

If this key assumption (4) holds, then the odds ratio of accidents of interest for vehicles with vs. vehicles without ESP, given the vehicle has had an accident is equal to relative risk of accidents of interest for vehicles with vs. vehicles without ESP in the population.

Since $D=D \cap A$, which can be appreciated by regarding figure 1,

$$\begin{aligned} P(D | E, \mathbf{x}) &= \frac{P(D, E, \mathbf{x})}{P(E, \mathbf{x})} \\ &= \frac{P(D, E, \mathbf{x}, A)P(A, E, \mathbf{x})}{P(E, \mathbf{x})P(A, E, \mathbf{x})} \\ &= P(D | E, \mathbf{x}, A)P(A | E, \mathbf{x}) \end{aligned} \quad (8)$$

and analogously $P(\bar{D} | E, \mathbf{x}) = P(\bar{D} | E, \mathbf{x}, A)P(A | E, \mathbf{x})$, $P(D | \bar{E}, \mathbf{x}) = P(D | \bar{E}, \mathbf{x}, A)P(A | \bar{E}, \mathbf{x})$, and $P(\bar{D} | \bar{E}, \mathbf{x}) = P(\bar{D} | \bar{E}, \mathbf{x}, A)P(A | \bar{E}, \mathbf{x})$. With these results, it is straightforward to rewrite $OR_{D|A}$ in the desired way:

$$\begin{aligned}
OR_D | A &= \frac{P(D | E, \mathbf{x}, A)(1 - P(D | \bar{E}, \mathbf{x}, A))}{P(D | \bar{E}, \mathbf{x}, A)(1 - P(D | E, \mathbf{x}, A))} \\
&= \frac{P(D | E, \mathbf{x}, A)P(\bar{D} | \bar{E}, \mathbf{x}, A)}{P(D | \bar{E}, \mathbf{x}, A)P(\bar{D} | E, \mathbf{x}, A)} \\
&= \frac{P(D | E, \mathbf{x}, A)P(\bar{D} | \bar{E}, \mathbf{x}, A)P(A | E, \mathbf{x})P(A | \bar{E}, \mathbf{x})}{P(D | \bar{E}, \mathbf{x}, A)P(\bar{D} | E, \mathbf{x}, A)P(A | E, \mathbf{x})P(A | \bar{E}, \mathbf{x})} \\
&= \frac{P(D | E, \mathbf{x})P(\bar{D} | \bar{E}, \mathbf{x})}{P(D | \bar{E}, \mathbf{x})P(\bar{D} | E, \mathbf{x})} \\
&= \frac{P(D | E, \mathbf{x})P(\bar{D} | \mathbf{x})}{P(D | \bar{E}, \mathbf{x})P(\bar{D} | \mathbf{x})} \\
&= \frac{P(D | E, \mathbf{x})}{P(D | \bar{E}, \mathbf{x})} \\
&= RR_D. \tag{9}
\end{aligned}$$

As a further step, the proportion of all accidents that can be prevented by introducing the active safety technology of interest can be obtained:

$$\begin{aligned}
1 - RR_{A,x} &= \frac{P(A | \bar{E}, \mathbf{x}) - P(A | E, \mathbf{x})}{P(A | \bar{E}, \mathbf{x})} \\
&= \frac{P(D | \bar{E}, \mathbf{x}) + P(\bar{D} | \bar{E}, \mathbf{x}) - P(D | E, \mathbf{x}) - P(\bar{D} | E, \mathbf{x})}{P(D | \bar{E}, \mathbf{x})/P(D | \bar{E}, \mathbf{x}, A)} \\
&= \frac{P(D | \bar{E}, \mathbf{x}) + P(\bar{D} | \mathbf{x}) - P(D | E, \mathbf{x}) - P(\bar{D} | \mathbf{x})}{P(D | \bar{E}, \mathbf{x})/P(D | \bar{E}, \mathbf{x}, A)} \\
&= \frac{P(D | \bar{E}, \mathbf{x}) - P(D | E, \mathbf{x})}{P(D | \bar{E}, \mathbf{x})/P(D | \bar{E}, \mathbf{x}, A)} \\
&= P(D | \bar{E}, \mathbf{x}, A)(1 - RR_D) \tag{10}
\end{aligned}$$

The subscript x in (10) shows that the relative risk of all accidents depends on the settings of the covariates. Logistic regression offers an estimate for $P(D | \bar{E}, \mathbf{x}, A)$, and therefore an estimate for $RR_{A,x}$ can also be obtained.

R. Choiejit
Department of Economics, Faculty of Social
Science, Srinakharinwirot University, Bangkok,
Thailand

R. Teungfung
Rajamongkala Institute of Technology, Nonthaburi
Campus, Nonthaburi, Thailand

The Patterns of Traffic Accidents in Thailand

Abstract

Traffic accidents were ranked the third among the major causes of death in Thailand. About 13,438 deaths and the death rate from traffic accident was 21.5 per 100,000 of population in 2002. The deaths and death rate varied upon the economic situation. After the economic crisis, traffic accidents were increased as well as the period of the bubble economy. In the Central region of Thailand numbers of road traffic crashes were lower than Bangkok Metropolis, but the highest in the number of deaths, death rate and serious injuries in 2002. Men aged 15–29 years old had higher numbers of deaths than men in other age groups and higher than women. Deaths and injuries from road traffic crashes were the highest in April and January, because there was a long weekend in those months. About 80 percent of road traffic crashes were caused by private car and motorcycle. In 2000 about 51 percent of traffic accidents took place on the straight way, followed by the junction and curves. In 2002, about 97 percent of road traffic crashes were caused by human factors including improper passing, speeding and disregarding to traffic signal, however, the identification of causes of traffic accident needed to improve. Drunk driving, disregarding on safety equipment usage, inefficiency of law enforcement and discontinuing of road safety programs were the deepest causes of traffic accidents. Research based information, a broad coalition of stakeholder and urban planning policy were needed to incorporate for a comprehensive road safety policy formulation and actions.

Introduction

Traffic accidents became a major problem in Thailand, not only a public health problem, but also

a Thai society problem. Deaths and injuries from road traffic accident increased rapidly following the rapid motorization during the period of bubble economy in the late 1980s. During that time, more than 200,000 and 250,000 newly registered personal cars and motorcycles, respectively, increased annually [1]. The negative effect of motorization in Thailand was an rapid increasing of the road traffic crashes. However, the number of traffic crashes in Thailand decreased during the period of the economic crisis in the late 2000s. Then, after the period of economic crisis, number of road traffic crashes increased in the period of economic recovery. This means that Thai society has to confront with a traffic accident problem. This study aims to explore the patterns and trends of traffic accidents in different geographic areas of Thailand, particularly after the period of economic crisis, and the characteristics of people injured or killed in road traffic crashes. Moreover, this study intends to investigate the risk factors of road traffic crashes.

Materials and Methods

This study reviewed the patterns and trends of traffic accidents and associated injuries and deaths based on the data compiled by various Thai government agencies. The two main sources of material data for this study were derived from:

1. Public Health Statistics compiled by the Bureau of Health Policy and Strategy, Ministry of Public Health, which provide the data of major causes of deaths, number of deaths and death rates in road traffic accidents, the characters of the deaths.
2. Criminal Statistics compiled by the Royal Thai Police Office, Ministry of the Prime Minister Affairs, which provide the number of deaths, injuries. Mode of transport in road traffic crashes, causes and places of traffic accidents and also financial losses due to traffic accidents were reported by this source of data.

Results

Traffic accidents were ranked the third among the leading causes of deaths in Thailand. About 13,438 deaths from traffic accidents as compared to 45,834 and 32,896 deaths caused by all forms of cancers and the disease of the heart and

cerebrovascular, respectively in 2002. The death rate from traffic accident was 21.5 per 100,000 of population as compared to 73.3 and 52.6 per 100,000 of population of the cancers and the disease of the heart and cerebrovascular, respectively in 2002 (table 1). A recent study on road traffic injuries in Thailand showed that the number and rate of traffic injury in Thailand swung from a low record during the economic recovery in the early of 1980s to a high record during the period of bubble economy, and then to a decline during the period of economic crisis. However, after the period of economic crisis, the number and rate of traffic accident in Thailand increased [2].

Table 2 shows in 1998 the lowest record in the period of economic crisis, about 7,986 deaths from traffic accidents. The number of deaths from traffic accident increased to 13,348 in 2002. The death rate increased from 13.1 to 21.5 per 100,000 of population between 1998 and 2002, respectively. This means that numbers of deaths and the death rates from traffic accidents in Thailand varied upon the economic situation. After the period of economic crisis, the trends of traffic accident in Thailand increased nearly as strong as in the period of the bubble economy [2], similarly to other Asian countries, for example, in Vietnam, China, and South Korea, where rapid motorization was fueled by economic growth over the last decade, resulting in a steadily increasing trend in the number of traffic crashes [3-5].

Data compiled by the Ministry of Public Health reported that the Central region of Thailand had the highest number of deaths and death rate both in 1998 and 2002. The number of deaths from road traffic crashes increased from 2,676 in 1998 to 5,054 in 2002. The death rate in the Central region also increased from 18.9 to 34.3 per 100,000 of population between 1998 and 2002, while Bangkok Metropolis, the capital city of Thailand, had the lowest, both in the number of deaths and death rates between 1998 and 2002 (table 3).

After the period of economic crisis in 1998 until the period of the economic recovery in 2002, the numbers of deaths and death rate of traffic accidents increased in all regions of Thailand, especially the Central region, the only region which had nearly a double increase in the number of deaths and death rate. This means that traffic accidents became a severe problem in Thailand, particularly in the Central region.

Leading Causes of Death	Deaths	
	Number	Rates
Total	380,364	608.1
Malignant neoplasm, all forms	45,834	73.3
Accident and Poisonings	34,566	55.3
Traffic Accidents	13,438	21.5
Disease of the heart and cerebrovascular	32,896	52.6
Pneumonia and other diseases of lung	13,185	21.1
Nephritis, nephrotic syndrome and nephrosis	10,587	16.9
Disease of liver and pancreas	8,025	12.8
Tuberculosis, all forms	6,751	10.8
Suicide	4,905	7.8
Hypertension and cerebrovascular disease	3,213	5.1
Dengue haemorrhagic fever	264	0.4
Others	220,138	351.9

Source: Public Health Statistics, Ministry of Public Health, Thailand, 2004

Tab. 1: Number of deaths and death rates per 100,000 population classified by leading causes of death in 2002

Years	Number	Rates	Economic Situations
1988	5,428	10.0	Economic Recovery
1989	6,617	11.9	Economic Recovery
1990	8,335	14.8	Economic Recovery
1991	10,155	17.9	Economic Recovery
1992	11,044	19.2	Economic Recovery
1993	12,321	21.2	Bubble Economy
1994	13,367	22.8	Bubble Economy
1995	14,479	24.4	Bubble Economy
1996	16,268	27.2	Bubble Economy
1997	12,832	21.2	Economic Crisis
1998	7,839	12.8	Economic Crisis
1999	11,315	18.4	Economic Recovery
2000	12,936	20.9	Economic Recovery
2001	12,722	20.5	Economic Recovery
2002	13,354	21.3	Economic Recovery

Source: Public Health Statistics, Ministry of Public Health, Thailand, 2004

Tab. 2: Number of deaths and death rates per 100,000 population from traffic accidents

Regions	1998		2002	
	Number	Rates	Number	Rates
Bangkok Metropolis	158	2.8	300	5.2
Central	2,676	18.9	5,054	34.3
North	1,705	14.1	2,523	20.8
North East	2,049	9.7	3,695	17.1
South	1,251	15.6	1,782	21.3

Source: Public Health Statistics, Ministry of Public Health, Thailand, 2004

Tab. 3: Number of deaths and death rates per 100,000 population from traffic accidents classified by regions in 1998 and 2002

Data compiled by the Royal Thai Police office was a major official data reporting the number of deaths and the levels of injury on traffic accidents in Thailand. It was showed that about 31 percent of

total traffic accidents in Thailand occurred in Bangkok Metropolis in 2002, but most of them were mild injuries. Contrary to this, the Central region had the highest number of deaths and serious injuries in 2002. About 29 and 32 percent of deaths and serious injuries took place in the Central region in 2002. The North Eastern was the secondary region with high numbers of deaths and serious injury in 2002 (table 4).

High levels of vehicle per capita in Bangkok Metropolis probably was the major cause of the higher number of mild injuries in Bangkok Metropolis, but lower number of deaths. Contrary to this the Central region, where a high speed movement of traffic prevails, was the secondary ranked in vehicle per capita both in private car and motorcycle. There as a high number of serious injuries and deaths in this region (table 5). Road traffic crashes occurred more frequently in the urban areas than in the rural areas, however, urban crashes were mild injuries, but rural crashes tended to be more severe. Moreover, the more economically developed the areas are, the higher rates of deaths and injury from road traffic crashes [2-4], [6-8] occur.

Men aged 15–29 years old had higher numbers of deaths than men in other age groups and women,

ReRegions	Death	Serious Injury	Mild Injury	Total
Bangkok Metropolis	13.2	13.7	40.4	30.6
North	18.9	21.7	16.7	18.1
North East	26.9	20.1	12.3	16.2
South	12.2	12.7	12.2	12.3
Central	28.8	31.8	18.5	22.8
Total	100.0	100.0	100.0	100.0
Number	13,116	16,806	52,507	82,429

Source: Criminal Statistics, The Royal Thai Police Office, Thailand, 2003

Tab. 4: Percentage distribution of traffic accidents classified by regions in 2002

Regions	Types of Vehicle	
	Motorcycle	Private car ^c
Bangkok Metropolis	0.41	0.49
North	0.30	0.08
North East	0.19	0.04
South	0.33	0.07
Central	0.35	0.14
Whole Kingdom	0.26	0.11

Source: a Land Transport Department, Ministry of Transport, Thailand, 2004
b Department of Local Administration, Ministry of Interior, Thailand, 2004
c Private cars are personal sedans and pick-up

Tab. 5: Vehicle per capita (vehicle per population b) classified by regions in 2002

both in 1998 and 2002 (table 6). Besides, numbers of deaths, data compiled by the Royal Thai Police Office, showed that men had higher numbers of serious and mild injuries than women in 2002 (table 7). Recent studies confirmed that young adult men had a high risk to be involved in traffic accidents. Young working age males are the traditional breadwinners of nuclear families. The loss or disability of the family member who provides the primary economic support leads to negative impacts on their family [2-4], [6-7], [9-12]. Interestingly, numbers of deaths were high in April and January, both in 1998 and 2002 the because there were large amounts of long weekend days in those months (table 8). For example, the Thai traditional new year is in April, an ordinary new year in January and the Chinese new year as well. The more weekend days, the higher is number of traffic accidents in Thailand [8].

In terms of transport mode, the private car was the most frequent transport mode involved in traffic accidents followed by motorcycle. The private car and motorcycle were about nearly 80 percent of traffic accidents in transport mode, both in 1998 and 2002. However, the percentage of traffic accidents caused by motorcycle increased from 30 to 36 percent between 1998 and 2002, while the percentage of private cars involved in traffic accidents decreased from 48 percent to 43 percent

Age Groups	1998			2002		
	Total	Men	Women	Total	Men	Women
0 - 14	563	356	207	829	529	300
15 - 29	3,280	2,829	451	5,534	4,712	822
30 - 44	2,194	1,821	373	3,712	3,053	659
45 - 59	1,107	875	232	2,076	1,598	478
60 +	691	489	202	1,199	878	321

Source: Public Health Statistics, Ministry of Public Health, Thailand, 2004

Tab. 6: Number of deaths from traffic accidents classified by age groups and gender in 1998 and 2002

Deaths and Injuries	Gender	Number
Deaths	Men	10,405
	Women	2,711
Serious Injury	Men	12,316
	Women	4,490
Mild Injury	Men	36,747
	Women	15,760
Total	Men	59,468
	Women	22,961

Source: Criminal Statistics, The Royal Thai Police Office, Thailand, 2003

Tab. 7: Number of deaths and injuries from traffic accident in 2002 classified by gender

between 1998 and 2002 (table 9). In Vietnam, China, Kenya and Colombia, where the population density is high, most urbanized and economically active, motorcycle and private car were the major causes of road traffic crashes [2-4], [7], [10]. When income increased, motorcycle, pick-up and sedan were the most popular private vehicles for Thai people to purchase, because it is not only a

Month	Number of Deaths		Death Rates	
	1998	2002	1998	2002
January	866	1,209	16.7	22.8
February	656	1,203	13.9	25.0
March	705	1,142	13.6	21.5
April	815	1,284	16.3	25.0
May	648	1,038	12.5	19.6
June	533	1,052	10.6	20.5
July	528	1,013	10.2	19.1
August	590	1,080	11.4	20.4
September	519	994	10.4	19.4
October	655	1,153	12.6	21.7
November	645	1,137	12.9	22.2
December	679	1,049	13.1	19.8
Total	7,839	13,354	12.8	21.3

Source: Public Health Statistics, Ministry of Public Health, Thailand, 2004

Tab. 8: Number of deaths and death rates from traffic accidents classified by month in 1998 and 2002

Mode of Transport	1998	2002
Pedestrian	3.0	3.0
Non-motorized	1.5	2.1
Motorcycle	30.2	35.7
Private Car	47.7	43.4
Van and Bus	5.4	4.7
Truck	5.9	5.1
Other	6.4	5.9
Total	100.0	100.0
Number of Cases	123,750	150,600

Source: Criminal Statistics, The Royal Thai Police Office, Thailand, 2003

Tab. 9: Percentage distribution of traffic accidents in Thailand classified by transport mode in 1998 and 2002

Types of Factor	Bangkok	North	North East	Central	South	Whole Kingdom
Human Factor	97.9	95.4	96.6	97.5	97.4	97.4
Speeding	24.5	33.9	43.9	39.7	36.0	30.6
Improper passing	40.0	24.3	30.0	34.4	35.8	36.2
Disregarding of traffic signals	18.4	23.6	11.6	14.8	18.5	17.7
Drunk driving	4.0	6.4	6.2	2.7	2.4	4.1
Other Human Factors	11.0	7.4	4.9	5.8	4.8	8.7
Non Human Factor	2.1	4.6	3.4	2.5	2.6	2.6
Vehicle factor	1.9	3.6	2.7	2.2	1.5	2.2
Other Non human factors	0.2	0.9	0.7	0.3	1.1	0.4
Total Percent	100.0	100.0	100.0	100.0	100.0	100.0
Identified Causes	38,460	7,203	6,685	10,354	5,498	68,200
Non identified Causes	4,563	4,793	829	3,862	1,831	15,878
Total Traffic Accidents	43,023	11,996	7,514	14,216	7,329	84,078

Source: Criminal Statistics, The Royal Thai Police Office, Thailand 2003

Tab. 11: Percentage distribution of identified causes of traffic accidents in Thailand classified by regions in 2002

vehicle, but it reflects the social classes in Thai society [1].

Table 10 shows that in 2000 the about 51 percent of traffic accidents took place on the straight way and about 22 percent of traffic accidents took place on junction. Nearly 9 percent of traffic accidents took place on the bridges and curves. This means that improving transport facilities such as traffic signal, quality of road and bridge are the importance measures to reduce incidents of road traffic crashes in Thailand. However, most roads in developing countries are poor and have been built for the different types of road users. Multi-purposes roads tend to have high traffic accident rates. Better road designs, which seek to segregate the slow moving, non-motorized transport from the fast moving motorized transport, will improve road safety in developing countries [13].

Table 11 shows that in 2002 about 97 percent of road traffic crashes in Thailand were caused by many aspects of human factors. Speeding or driving over speed limitation (90 kilometer per

Types of Places of Traffic Accidents	2000
Straight Way	50.8
Curves	8.3
Narrow lane	3.1
Bridge	9.0
Junction	21.6
U-turn	0.6
Entrance-Exit	4.1
Other	2.6
Total	100.0
Number of Crashes	73,737

Source: Criminal Statistics, The Royal Thai Police Office, Thailand, 2003

Tab. 10: Percentage distribution on places of traffic accidents in Thailand in 2000

hour), improper passing and disregarding of traffic signal were the major causes of road traffic crashes in Thailand, while about only 3 percent caused by non-human factors such as vehicle factor. In addition, Thailand injury surveillance report (2000) indicated that human factors were the deepest rooted causes of road traffic crashes, which were drunk driving and disregarding of safety equipment such as helmet, seat-belt and a low quality of safety equipment used. Recent studies indicated that drunk driving, driver fatigue and the use of cell phone also were the most important human factors causing a driver to commit an error while driving [5], [14]. The higher rates of road traffic crashes caused by human factors reflect an inefficiency of traffic regulation enforcement and the attitude on road safety for Thai travelers.

Only official data of the Royal Thai Police Office reported that after the period of economic crisis in 1997, the direct financial losses increased from 34.5 million US dollars in 1998 to 37.4 million US dollars in 2002. The direct financial losses were reported the highest in Bangkok Metropolis, however, the percentage dropped from 43.8 percent to 40.4 percent in 1998 and 2002, respectively. Not only Bangkok Metropolis was decreased proportionally to the direct financial losses, but also this, the North East and South as well. Contrary to the direct financial losses in the Central region increased rapidly from 16.8 percent to 23.1 percent between 1998 and 2002, respectively, while the North slightly increased in the direct financial losses from 11.3 to 12.8 percent between 1998 and 2002, respectively (table12). However, this figure was underestimated, because comprehensive figures are not available in Thailand nowadays.

In 1995, it was estimated that the indirect costs of road traffic crashes in Thailand were about 600

Regions	1998	2002
Bangkok Metropolis	43.8	40.4
North	11.3	12.8
North East	15.1	12.7
South	13.0	11.1
Central	16.8	23.1
Total	100.0	100.0
Whole Kingdom	34,491,846	37,373,420

Source: Criminal Statistic, The Royal Thai Police Office, 2003
 a Currency rate: 40 Baht per US Dollar, approximately

Tab. 12: Percentage distribution of direct financial losses from traffic accidents in Thailand in 1998 and 2002 classified by regions (US Dollar)^a

million US dollars, including the probability of injury, disabled person and family care and the loss of income. When adding up the direct costs of road traffic crashes, which were the costs of health care and damage of property, they amounted on about 1,600 million US dollars in 1995. This figure equivalent to about 23 percent of total health expenditure or about nearly 1 percent of Thailand's GDP in 1995 [15]. In Vietnam, it is estimated that the costs of road accidents was at least 2 percent of GDP in 2002 [3]. In 1995 the estimated annual economic cost of road traffic injuries in Kenya, which included health care costs, administrative expense, vehicle and property damage, were about 343 million US dollars or about 5.5 percent of the GNP [10].

Discussion

This study reviewed the patterns of traffic accidents in Thailand from secondary data compiled by various government agencies. It indicated that traffic accidents were increased rapidly in all regions of Thailand after the period of economic crisis in 1997. Nowadays, the number of road traffic crashes increased nearly as strong as in the period of bubble economy in the early of 1990s. Traffic accidents in Thailand varied upon the economic situation, higher per capita income, higher number of road traffic crashes. Increased income leads to an increasing in vehicle ownership, both private car and motorcycle. Rapid increase of road traffic crashes took place not only in Bangkok Metropolis, but also in other regions of Thailand, particularly the Central region, the secondary ranked on vehicle per capita. Deaths, death rates and serious injuries increased more rapidly in the Central region rather than in the rest of Thailand.

Drunk driving, violation of traffic regulation and disregarding of safety equipment usage such as helmets and seat-belt were the major causes of road traffic crashes in Thailand [2,8,16-18]. However, the identification of causes of road traffic accidents needed to be improved urgently. The weakness of legal enforcement by government officers, particularly the police officers, was a major obstacle to overcome the road traffic injury problems in Thailand, for example, an unclear policy guidance, lack of budgetary and training, broader personal interpretation and non-systematic on monitoring and evaluation, etc [2], [8], [16-18].

Appropriate organization and management of resources, which are human, financial, information and technological resources, will lead to desirable outcomes on road safety policy. In addition the development of accuracy information and maintenance systems is the most important for policy formulation, monitoring and evaluation. The current government created many campaigns to reduce traffic accidents such as the Anti Drunk Driving , Helmet and Seat-belt Using Promotion and Public Awareness of traffic accident, etc. However, the discontinuance of those campaigns and the weakness of institutional structure and the inappropriate policy process, lead to the undesirable outcomes to reduce road traffic crashes in the short run [2], [8], [16-18].

Encouraging civil society and the public participation should take into account the road safety policy, defining the problems, identifying solutions and advocating of policy decisions and implementation. The process of multiparty movements needs to be based on research based approaches to provide reliable information, methodologies and evidences. A broad coalition of stakeholders is needed to catalyze a comprehensive road safety policy formulation and actions. In addition, urban design and road segregation, which were popular to promote road traffic programs in Western societies, but less in developing countries, especially in Thailand, have to be put forward [1], [13]. Therefore, urban planning policy plays one of the substantive roles to succeed in road safety policy.

Conclusion

Traffic accidents became a major cause of death in Thailand. The trends of road traffic crashes increased rapidly following the Thai's economic performances during the period of economic recovery. Though the current government created a lot of road safety programs to reduce number of deaths and injuries from traffic accidents, however, inefficiency of law enforcement, discontinuance of prevention programs, the weakness of institutional structure and insufficient resources allocation were the major obstacles to desirable outcomes of road safety policy. Research based information, a broad coalition of stakeholders and urban planning policy needed a to incorporate for a desirable road safety policy formulation and actions.

References

- 1 CHOIEJIT, R.: The Relationships Between Population Density and Commuting Patterns in Bangkok. Ph. D. Dissertation: Mahidol University, Nakhon Pathom, 2002
- 2 SURIYAWONGPAISAL, P., KANCHANASUT, S.: Road Traffic Injuries in Thailand: Trends, Selected Underlying. Determinants and Status of Intervention. *Injury Control and Safety Promotion*, Vol. 10, No 1-2, pp. 95 – 104, 2003
- 3 LINH, C. LE, et al.: Vietnam Profile on Traffic-Related Injury: Facts and Figures from Recent. Studies and Their Implications for Road Traffic Injury Policy. Paper Presented at Road Traffic Injuries and Health. Equity Conference, Cambridge, Massachusetts, 2002.
- 4 SHEN-YONG, W. et al.: Trends in Road Traffic Crashes and Associated Injury and Fatality in the People's Republic of China, 1951-1999. *Injury Control and Safety Promotion*, Vol. 10, No 1-2, pp. 83 – 87, 2003
- 5 Bong-MIN, Y., JINHYUN, K.: Road Traffic Accidents and Policy Interventions in Korea. *Injury Control and Safety Promotion*, Vol. 10, No 1-2, pp. 89 – 94, 2003
- 6 F. K. AFUKAAR, et al.: Pattern of Road Traffic Injuries in Ghana: Implications for Control. *Injury Control and Safety Promotion*, Vol. 10, No 1-2, pp. 69 – 70, 2003
- 7 DEYSI, Y. R. et al.: Road Traffic Injuries in Colombia. *Injury Control and Safety Promotion*, Vol. 10, No 1-2, pp. 29 – 35, 2003
- 8 Division of Epidemiology: Ministry of Public Health, *Injury Surveillance Report Thailand, 1995 – 1999*, Nonthaburi, 2000
- 9 S. N., FORJUOH: Traffic-Related Injury Prevention Interventions for Low-Income Countries. *Injury Control and Safety Promotion*, Vol. 10, No 1-2, pp. 109 – 118, 2003
- 10 ODERO, W. et al.: Road Traffic Injuries in Kenya: Magnitude, Causes and Status of Intervention. *Injury Control and Safety Promotion*, Vol. 10, No 1-2, pp. 53 – 61, 2003
- 11 VINAND, M. et al.: Equity Dimensions of Road Traffic Injury in Low and Middle Income Countries. *Injury Control and Safety Promotion*, Vol. 10, No 1-2, pp. 13 – 20, 2003

- 12 HIJAR, M.: Pedestrian Traffic Injuries in Mexico: A Country Update. *Injury Control and Safety Promotion*, Vol. 10, No 1-2, pp. 37 – 43, 2003
- 13 AFUKAAR, F. K.: Speed Control in Developing Countries: Issues, Challenges and Opportunities in Reducing Road Traffic Injuries. *Injury Control and Safety Promotion*, Vol. 10, No 1-2, pp. 77 – 81, 2003
- 14 SMITH, D. J.: Human Factors and Traffic Crashes. Center for Transport Research and Education, Iowa State University, 2000
- 15 TOSUTHO, R.: Economic Loss and Road Accident Related Factors. Ph. D. dissertation, Chulalongkorn University, Bangkok, 1998
- 16 SURIYAWONGPAISAL, P. et al.: Application of 0.05 Percent Legal Blood Alcohol Limits of Traffic Injury Control in Bangkok. *Journal of Medical Association Thailand*. Vol. 85, pp. 496 – 501, 2002
- 17 CHONGSUVIVATWONG, V. et al.: High Prevalence of Drunk Driving in Thailand. *Drug and Alcohol Review*, Vol. 18, pp. 293 – 298, 1999
- 18 SURIYAWONGPAISAL, P. et al.: Compliance with Law on Car Seat-Belt Use in Four Cities of Thailand. *Journal of Medical Association Thailand*. Vol. 83, pp. 333 – 341, 2000

R. Nagel
Secretary of German Ministry of Transport,
Building and Housing, Berlin, Germany

Keynote Lecture: Importance of In-Depth Investigation for Road Safety

Ladies and Gentlemen,

I am very glad to be here in Hannover today for the first ESAR Conference. I would like to avail myself of this opportunity to set forth to you the essential aspects of the road safety policy of the Federal Government.

In order to take due account of the subjects addressed here, I will first of all present the development of road safety in the Federal Republic of Germany in the European context, explain the efforts undertaken for further improvement, taking a special case – namely the accident data surveys on the ground – as an example and show you the benefits resulting from this or the success achieved.

In a Europe which is growing together the mobility factor is of central importance. A maximum level of mobility can, however, only be achieved in close interaction with a maximum level of road safety. This correlation was also taken up by the European Commission and in its White Paper on European Transport Policy, the proposal is made to cut the number of road deaths in the EU by 50% over a period of 10 years until 2010. That means for Europe a reduction of the figure of fatalities in road traffic from 40,000 to 20,000 persons.

In the 3rd Road Safety Action Programme which was presented in July 2003, the measures taken in this connection were more clearly defined. Their aim is to

- induce road users to improve their behaviour in road traffic, especially by better observance of the applicable rules and regulations, by the improved initial and advanced training of private drivers and professional drivers and by continued efforts to counteract dangerous driving behaviour;
- enhance vehicle safety, in particular by technical standardization and the support of technological progress;

- improve the road infrastructure, especially by identifying best practice solutions and their dissemination at local level as well as black spot management.

In order to reach a broad consensus, the Commission proposes to those vested with directive and decision-making powers and to those having the possibility of enforcing such measures at economic and social level or the power of representation to accede to a European Road Safety Charter. Apart from the observance of general principles, each signatory undertakes to set targets of his own and to implement the relevant measures. The commitments thus incurred will be published and their fulfilment will be observed.

The 3rd Road Safety Action Programme includes many parallels in comparison with the German programme for the improvement of road safety. Our national programme, too, is characterized by the following key elements:

- protection of the vulnerable road users (especially children and senior citizens),
- improvement of road user behaviour,
- improvement of motor vehicle engineering, making use of telematics and/or eSafety
- improvement of the transport infrastructure.

With the aid of a package of measures including 100 items, the German road safety programme will tackle five priority tasks:

- Point 1: Improvement of the road culture

The general road culture in Germany has significantly deteriorated during the last few years. An increased aggressiveness, time pressure and an ever-increasing traffic volume are reflected by speeding, tailgating and inconsiderate driving, leading to a higher accident risk. A change of this culture towards more considerateness and calmness of the road users is to enhance road safety. Safe mobility requires the cooperation of all those involved in road traffic on the basis of mutual understanding.

- Point 2: The protection of vulnerable road users

Nearly half of all fatalities in 2003 are so-called "vulnerable road users". The purpose of the Road Safety Programme "vulnerable road users" comprises, inter alia,

children and senior citizens which make up a share of 23% (1,537 persons) of the total number of fatalities. Pedestrians, cyclists and motorized two-wheel riders form another group which is subject to a relatively high risk in road traffic. In these cases the personal consequences of a traffic accident are much more severe. There were more than 2,500 persons from this group killed in 2003, this is a share of 39%. The aim of the German Road Safety Programme is to improve road safety for the vulnerable road users not only by correcting their own behaviour, but also by influencing the “stronger “ road users.

- Point 3: Reducing the accident risk of young drivers

The high percentage of novice drivers in the age group from 18 to 20 years involved in accidents is mainly attributed to a lack of driving experience and a higher willingness to take risks. First priority is given in the programme to reducing this risk-taking behaviour of the young drivers and to giving them incentives for voluntary learning.

- Point 4: Reducing the danger potential of heavy commercial vehicles

Heavy commercial vehicles, especially heavy lorries, are often felt by the other road users to be threatening and dangerous. Due to their dimension and weight, accidents involving heavy commercial vehicles are often disastrous. It is important to further reduce the danger potential emanating from heavy lorries especially. The same applies to buses and light vans.

- Point 5: Increasing the safety on rural roads

Accidents on rural roads in most cases have particularly serious consequences: Nearly 2 out of 3 persons killed in road traffic are victims of accidents on rural roads. The main aim in improving road safety here is to avoid accidents outside built-up areas due to speeding, leaving the carriageway, and errors when overtaking. This is mainly a challenge for the federal states.

Looking back, the implementation of the measures presented here can quite rightly be considered to have been successful. Despite a continuously increasing kilometre performance and a growing motor vehicle fleet, the number of persons killed on

the road fell in 2003 with 6,613 fatalities to the lowest level since the introduction of the road traffic statistics in 1953. In the first half of 2004 it was found that the number of fatalities was further reduced by 14% compared to the preceding year.

Despite this favourable trend, however, we must not be complacent with what we have achieved.

This is true on the one hand because the numbers hide personal tragedies and immeasurable suffering, and on the other because accident figures are also connected with economic costs amounting to 34,5 billion Euro due to personal and material damage. This alone is sufficient motivation for us to continue to do everything we can in order to further improve road safety.

To better reach this ambitious and demanding target, interdisciplinary research into the causes and consequences of accidents by medical experts, vehicle engineers and transport technologists is indispensable.

This is nothing new. Since the beginning of the 70s, the Federal Ministry of Transport, Building and Housing has been funding, in the framework of the accident research work of the Federal Highway Research Institute, a project concerned with local accident surveys. Today, the data base which was established in the course of this work over more than 30 years can rightly be regarded as one of the qualitatively best and most comprehensive data bases on road accidents in the world.

Ever more detailed and profound questions posed by up-to-date accident research work, however, require an ever growing amount of relevant accident data.

In 1999, this necessity led in Germany to the establishment of the GIDAS project (German In-Depth Accident Study) which is supported by our Ministry.

This project which is carried out jointly by the Federal Highway Research Institute (BAST) and the Research Association Automobile Engineering (FAT) examines more than 2,000 road accidents at the locations Hannover and Dresden every year. The accident surveys are very detailed. When the concept of this joint project was developed it was therefore possible to have recourse to the extensive and long-term experience of the local accident surveys.

In addition to the already established survey team of the faculty of medicine, a second team was organized by the Research Association Automobile Engineering at the Technical University of Dresden. This intensification of national accident research considerably improves the statistical validity of the data collected. The reasons for this are, apart from the larger number of single accidents examined, the different regional structures of the survey areas.

Accident surveys are the foundation of sound basic research and they are a first essential contribution to a further reduction of the number of accident victims.

The data collected are stored in a central data base and evaluated in different ways.

For the legislator, the data offer a possibility of closely observing accident situations and of early recognizing negative developments. The extensive documentation of accidents with detailed information on vehicle deformation, causes of injuries to passengers and other road users – like pedestrians and cyclists – make it possible to develop the foundations of legislation. They can be used, for example, for the description of suitable test procedures for type approvals.

In the past, studies of accident researchers have had an influence on the development of EC Directives and, looking back, they can be regarded as extremely successful. As examples I would like to mention here studies on the effectiveness of the seat-belt, on the necessity of wearing helmets when cycling, or on the preventive use of protective helmets for motorcycle riders.

For the automobile industry and the Federal Highway Research Institute, the GIDAS data base opens up possibilities of making comparisons between real accidents and crash tests. Structures that may lead to injury can be identified. Furthermore, the data are used for the establishment of test programmes, for the support and validation of computer simulations and for the recognition and assessment of potential areas of future safety developments.

For road traffic engineering it is possible to assess the potential severity of accidents in case of collisions between vehicles and objects in the street environment. You will not be surprised to hear that in the scale of accident consequences trees rank “very high”, crash barriers “medium high”, and no obstacles on the roadside “very low”.

On the basis of two examples from recent years, I would now like to demonstrate to you the need for, and the benefit of, detailed accident data with regard to an efficient road safety policy.

The first example I would like to mention is the EC Directive on the protection of occupants of motor vehicles in the event of a frontal impact which you know well. It was only possible to develop the definition of the relevant test procedure – which includes, inter alia, test speed, crash angle and overlapping ratio between the vehicle and the barrier – by means of local accident surveys. The results of these surveys on accidents in Germany were used during the international negotiations and taken into account for the elaboration of the Directive. In this way, it was ensured that an important type of accident, namely frontal impact, was taken into account in the EC Directive.

The second example concerns the protection of occupants of motor vehicles in the event of a side impact which is also required under an EC Directive. As in the case of the frontal impact, the relevant accident situation was defined on the basis of the accident data collected. In this way, it was possible to lay down the impact conditions for the crash test. In addition, a suitable crash test dummy had to be developed for this EC Directive, capable of measuring the strain on the most affected parts of the occupants' bodies. This required information on the most frequent bodily injuries and the way these injuries are sustained and this could only be gained from the analysis of real accident data. This research led to the development of the EuroSID, the European Side Impact Dummy which is now required by law.

At the European level, efforts are being made in order to standardize the existing national accident data surveys or those funded by automobile manufacturers in Europe and to make data comparable. A European accident database allowing representative statements – e.g. on the importance of particular accident situations or on the frequency of injuries and the mechanisms involved when injuries are sustained – is certainly desirable since measures to increase road safety in Europe could be introduced on a more targeted basis. However, dealing with this issue has proved to be very difficult as regarding the question which data have to be collected in detail and who bears the costs.

Furthermore, it is no longer sufficient to collect accident data exclusively in the field of passive vehicle safety. Due to the increasing number of electronic safety systems in vehicle construction and the possibilities for interaction between traditional passive and active safety opened up in this way, information is also needed with regard to the components of active safety. This applies in particular to the way these components work in accident situations.

The points mentioned and the commitment of the Federal Government show that road safety policy has the highest political priority. For the Federal Government any road death is one road death too much.

Ladies and Gentlemen, thank you for your attention. I wish you a successful conference.

Session: Vulnerable Road Users

T. Serre, C. Perrin, M. Bohn, M. Llari, C. Cavallero

J. K. Yang, D. Otte, J. F. Yao

B. Lorenz, R. Sferco

K. Okamura, S. Ito

J. P. Dias

D. Margaritis, Y. W. R. de Vries, H. G. Mooi

T. Serre, M. Bohn, M. Llari, C. Cavallero
INRETS, Laboratory of Applied Biomechanics,
Université de la Méditerranée, Marseille, France

F. C. Perrin
INRETS, Department of Accident Mechanism
Analysis, Salon de Provence, France

Detailed Investigations and Reconstructions of Real Accidents Involving Vulnerable Road Users

Abstract

The aim of this research is to improve knowledge about vulnerable road users accidents and more specifically pedestrians or cyclists. This work has been based on a complete analysis of real accidents.

From accidents chosen from an in-depth multidisciplinary investigation (psychology, technical, medical), we have tried to identify the configuration of the impact: car speed, pedestrian or cyclist orientations... Then, we have made a numerical modelling of the same configuration with a multibody software. In particular, we have reproduced the anthropometry of the victim and the front shape of the car.

A first simulation has been performed on this starting configuration. Next, effects of some parameters such as car velocity or victim position at impact have been numerically studied in order to find the best correlations with all indications produced by the in-depth analysis.

Finally, the retained configuration was close to the presumed real accident conditions because it reproduces in particular the same impact points on the car, the same injuries, and is according to the driver statement.

This double approach associating an in-depth accident analysis and a numerical simulation has been applied on pedestrian-to-car and bicyclist-to-car accidents. It has allowed us to better understand the real kinematics of such impacts. Even if this method is based on a case to case study, it underlines which parameters are relevant on a vulnerable road user accident investigation and reconstruction.

Introduction

The theme of this research concerns the study of vulnerable road users and more precisely the study of collisions of car-to-pedestrian and car-to-cyclist. The results of these two categories of vulnerable road users, in terms of road safety, show that the stake is substantial. In fact, even if the global evolution of road safety in France was quite positive in 2003, about 19000 pedestrians or cyclists were however injured, representing 16.4% of all road accident casualties. With a number of 782 people killed, these vulnerable road users represent also about 13.6% of all the deaths in fatal accidents [1]. This category of transport users has been qualified as vulnerable because of their lack of protections. Furthermore, in the past few years, their safety has not been always taken into account compared to the means invested in the field of car safety.

So the aim of this research is to improve knowledge about vulnerable road users accidents more specifically pedestrians or cyclists run over by cars. The objective was to perform complete and detailed analysis of real accidents. Several studies have been carried out in this field with different approaches. Some authors established relationships between impact velocity and injuries in order to provide information concerning the accident reconstruction [2, 3]. Other works modelled the movement of pedestrians from simplified mechanical equations [4]. A more complex approach considers the human body as a single segment rigid body [5].

The methodology set up here is a joint effort performed at INRETS (French National Institute for Transport and Safety Research) between two complementary approaches: an active safety approach based on an in-depth multidisciplinary investigation (psychology, technical, medical) of real accidents and a passive safety approach based on a numerical simulation of the crash.

Concerning the active safety approach, the Department of Accident Mechanism Analysis of INRETS has been carrying out in-depth investigations on road accidents since the beginning of the 80s. The particularity of these in-depth studies is that the investigations of the multidisciplinary team, composed of a psychologist and a technician, are actually made on the scene of the accident, at the same time as the intervention of the rescue services. The present study is mainly orientated on primary safety. It is focused on the study and the

identification of the accident production mechanisms but covers also the field of secondary safety and allows collaborations and exchanges notably with the INRETS Laboratory of Applied Biomechanics. In-depth study of accident cases belongs to the research field we could call “clinical accidentology”, and it is complementary with statistical and epidemiological studies [6-8]. In-depth accident studies allow moreover the understanding of the dysfunction of the driver-vehicle-infrastructure system [9]. Accident cases corresponding to the type of collision studied were selected among the most well documented, to be used as examples for the conception and adjustment of simulation models of crashes.

With regard to the passive safety approach, the Laboratory of Applied Biomechanics has studied the pedestrian impact for many years in collaboration with mainly Chalmers University and Faurecia [10-12]. The principal objectives of previous studies were to gain a better understanding of the influence of bumper design on pedestrian lower leg injuries and pedestrian behaviour [10, 12, 13]. However, such studies concern only the pedestrian impact in a well known configuration close to the standard recommendations: frontal impact for the car, lateral for the pedestrian, speed less than 40km/h ... But are such configurations representative of reality? Do we observe the same pedestrian behaviour (in terms of kinematics for example) in real accidents? The same injuries? This is also one of the purposes of this study. Another objective is to extend our knowledge to the field of the behaviour of cyclists impacted by a car. In the future, this study could be used to compare kinematics between pedestrians and bicyclists like [14]. Is it close to the pedestrian? Do we observe the same injuries? Will pedestrian safety countermeasures suggested or imposed on car manufacturers be useful to bicyclists?

This work is partly supported by the French transport minister (DSCR) and is partly included in the framework of the APPA project (Amélioration de la Protection du Piéton lors de collision par des Automobiles).

Method

In-Depth Accident Investigation

The principal aim of this investigation is to study and identify the accident production mechanisms. So we try to understand the dysfunctions of the

driver-vehicle-infrastructure system and we accord a particular attention to interactions between all its three components. However, since 1992 our in-depth accident investigation has also covered the field of secondary safety. Our data base contains around 500 accidents cases aged less than 10 years, and we have now collected about 50 cases a year.

The survey area circles the town of Salon-de-Provence (37000 inhabitants) and covers about 600km². It is characterized by a large diversity of road infrastructures: motorways, major and minor roads and also a few winding roads. To complete this principal survey sector with a more urban area, we have also investigated, since the year 2000, the accidents in the town of Aix-en-Provence (137000 inhabitants).

Investigators are on duty one week in three, 24h/24h. They are alerted by means of a short message system (SMS) sent by the central computer of the rescue service when there is a road accident in our investigation area.

The intervention on the accident scene is made as quickly as possible (about 15 minutes after the accident happened) in order to collect fugitive data. For the technician, they are, for example, final positions of vehicles, position of the point of collision, skid marks, occupancy and load of vehicles... For the psychologist, it is very important to rapidly interview the persons involved and the possible witnesses to collect the story, the scene, they have been lived through or rather the perception they have of it. If possible, it is preferable to collect these labile data before these persons undergo a thorough questioning by the police. It is necessary to remember that the aim of our study is completely different from that of the police. They are looking for the person responsible for the accident; we are looking for an understanding on how and why the accident happened. So statements are sometimes different. The technician films the scene of the accident, takes pictures and makes measurements to later draw up a precise plan, the psychologist records the interviews (see figure 1).

Both investigators pool the data collected in this first phase in order to guide the second one. A few days after, the technician checks the vehicle: state of safety parts, brakes, tires, suspensions... He also measures the deformations, and checks the interior of the vehicle to understand if possible how lesions appeared on occupants (see figure 1).



Fig. 1: In-depth investigation on the scene of the accident

Medical data concerning the victims is collected by the emergency service of the Salon-de-Provence hospital. The psychologist makes a second interview to improve knowledge of the persons involved, their health conditions, their experiences of driving, their experience of the car and the road they drove on...

After that, an important amount of work is necessary to format all these data and to capture them in computer.

An engineer computes the reconstruction of the accident generally using a kinematics method [15]. Starting from the final position of the vehicle, the principle consists of going back on the time and on the trajectory of each vehicle by applying a chain of simple kinematics sequences. The parameters are determined by taking into account all signs or indications collected on the scene of the accident like skid marks on the road for example. When the reconstruction proposed is in agreement with all indications available, we adopt it for this case as being the most probable one.

Finally, a global synthesis of the accident is drawn up by both investigators relating the whole story of the accident.

Numerical Simulation

In order to gain a better understanding of the real kinematics and the injury mechanisms of the vulnerable road user during the impact, we have decided to simulate numerically the real accidents with a multibody software. The Madymo V6.0 has been used to develop the numerical models and to perform the simulations.

Model Description

The whole multibody model is divided into two parts: the car and the vulnerable road users (the pedestrian or the bicyclist).

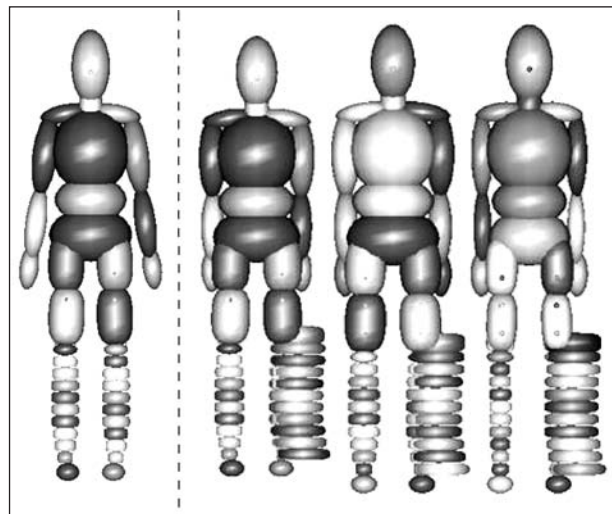

Fig. 2: Multibody model of the pedestrian and morphology adaptation

The human body model has been previously developed by the University of Chalmers [11] and then improved by Faurecia [12]. It represents a human body close to the 50th percentile male: 1.75m, 78kg. It includes 35 bodies with 35 joints and it is represented by 85 ellipsoids (see figure 2). Joint and body segment characteristics are based on available biomechanical data [16, 17]. The specific characteristics of this model concern its lower leg because it is predictive of some injuries. In particular it includes a human-like knee joint (femoral and tibial condyles, anterior and posterior cruciate ligaments, medial and lateral collateral ligaments) and a breakable leg which can simulate multiple lower leg fractures. Moreover, this model has been improved in order to simulate upper leg fracture so this body segment has been divided into several bodies.

Because the morphology of the subject is a relevant parameter in terms of kinematics or injuries during a pedestrian impact, we have adapted the human body model geometry to the real dimensions of the person involved in the

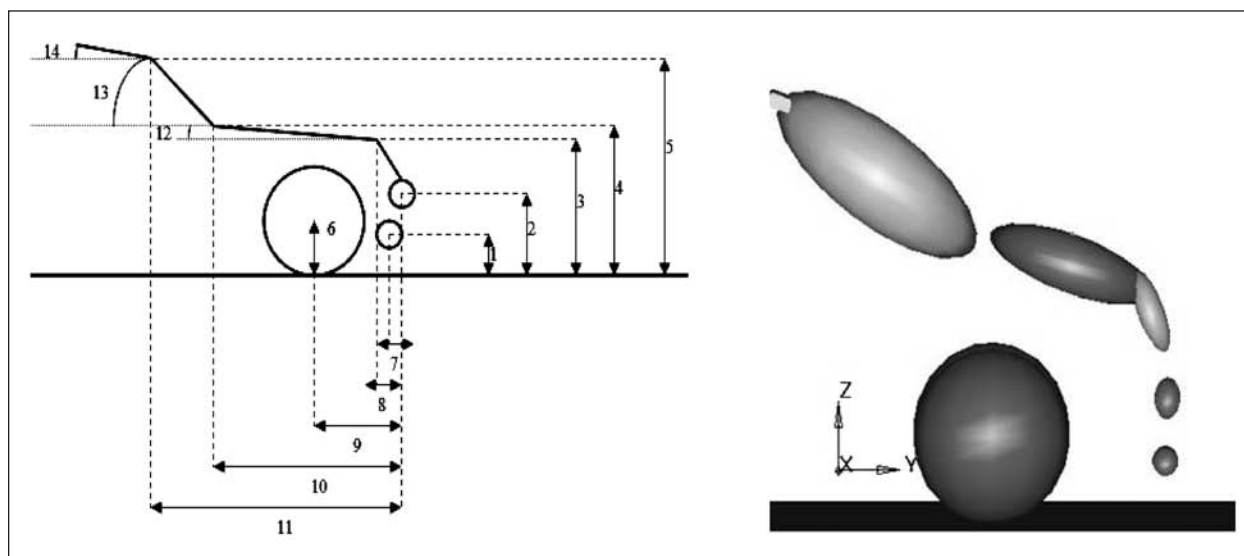

Fig. 3: Multibody model of the car and geometry measurements

accident. To do this work, we have used information (such as height, and weight) provided by the medical records available in the in-depth investigation. The model adaptation is divided into three steps: a scaling of the height, a dimension adjustment from more than 50 anthropometric measurements (if available), a new repartition of the weight in function of the new morphology (see figure 2).

Concerning bicyclist modelling, a classical French bicycle (VTT) has been added and then the pedestrian is placed on the bicycle in a standard position.

As for the vehicle model, it has been represented using more than 10 bodies. Its geometry is based on 19 measurements performed directly on the car involved in the accident when it is possible (see figure 3). If necessary some complementary measurements are performed on a similar vehicle using a 3D arm Faro.

Model Validation

This model has already been validated qualitatively but also quantitatively in pedestrian configuration by comparison with PMHS (Post Mortem Human Subject) experimental tests performed at INRETS-LBA [10]. This validation has been based on different car geometries (family or small urban cars) at different impact speeds (32km/h and 40km/h) [12]. So it could be considered that this model is representative of the kinematics for an impact speed less than 40km/h.

Concerning the configuration of a bicycle impact, no validation has been made. In this way, new full-scale impact tests (crash-tests) with PMHS have been performed. The protocol of such tests was to achieve collisions between a car and a bicyclist in a configuration close to a pedestrian one. Impact was frontal for the car and lateral for the bicyclist (nearest perpendicular to the front of the car). The overall kinematics of the human body model appears to be in agreement with observations from high speed films (see figure 4). The time histories of the linear accelerations show good correlations with test measurements.

Real Accident Simulation

The next step is to use this multibody model in order to simulate real accidents. From accidents chosen in the in-depth investigation database, we have tried to identify the configuration of the impact in terms of: car speed, impact orientation, pedestrian or cyclist positions... This work has been performed in particular during the kinematics reconstruction based on in-depth investigation.

Then, we have made the corresponding multibody model of this configuration with Madymo V6.0. In particular, we have reproduced the anthropometry of the victim and the front shape of the car as it was described before.

A first simulation has been performed on this starting configuration provided as being the most probable one by the reconstruction. Next, effects of some parameters such as car velocity or victim position at impact have been numerically studied in

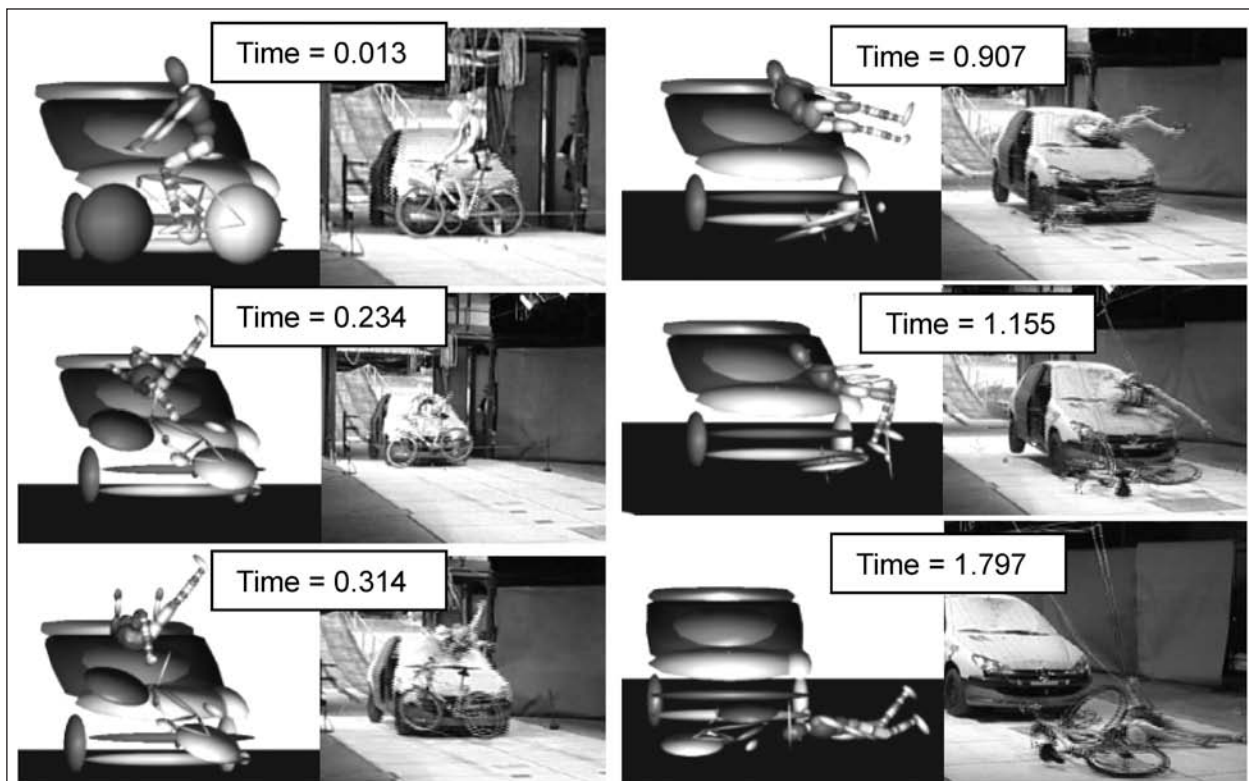

Fig. 4: Qualitative validation of the multibody model in car to bicyclist configuration

order to find the best correlations with all indications produced by the in-depth analysis.

Finally, the retained configuration is close to the presumed real accident conditions because it reproduces in particular the same impact points on the car, the same injuries, and is according to the driver statement.

Results

In order to illustrate this general methodology associating a detailed investigation and a multibody simulation of real accidents involving vulnerable road users, two cases are presented below. The first one concerns a pedestrian impact close to the “classical” configuration studied in experimental tests. The second one is a bicyclist accident in a different configuration.

For both of them, we first describe the configuration of the accident and then the multibody simulation.

Real Pedestrian Accident

In-Depth Investigation

On a January day, at 9 a.m., it is light and the weather is clear, Mrs X is driving a Citroën Xantia

on a Salon-de-Provence boulevard. She is coming back home to a small village in the south of Salon. She was driving at about 45km/h, she said, when she perceived, at the last minute, an old man, in the middle of her lane on a pedestrian crossing. She braked in emergency but the impact was unavoidable. Her car crashed into the right side of the pedestrian who died on the spot (see figure 5). Mrs X was not injured but she was badly shaken by the accident.

Several impact areas were observed on the Xantia: one on the low bonnet (1), one on the high bonnet (2) and one on the windscreen (3) (see figure 5).

Thirteen meters of skid marks were measured and we evaluated the deceleration during the braking phase to -8m/s^2 . Finally, the cinematic reconstruction of this accident using the methodology described in [15] shows an approaching speed for the car of approximately 60km/h and an impact speed of about 55km/h. Moreover, these speeds are in correlation with the usual speed measured on this road.

The pedestrian was 85 years old; he was 1.65m tall and weighed 75kg. His injuries estimated on the scene of the accident by a doctor were: open fracture of the right shoulder, right ribs fractures, fractures of the two femurs, face wounds.

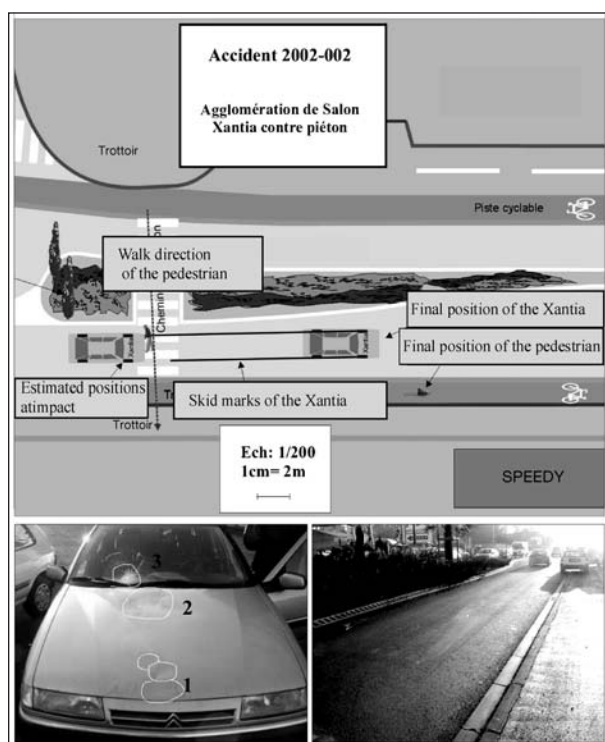

Fig. 5: Accident map, impact points on the Xantia and skid marks

Comparisons between injuries and impact areas on the car could provide a first estimation of the pedestrian cinematic. In this first estimation we could associate femurs fractures to the low bonnet impact, ribs and shoulder fractures to the high bonnet and face injuries to the windscreen impact.

Numerical Simulation

First of all, the multibody model was modified in order to correspond to this accident. The human body model was adapted to the anthropometry of the old man (1.65m, 75kg) and the front shape of the Citroën Xantia was represented from measurements carried out on a car of the same type.

Then a first simulation was performed on the configuration provided by the in-depth investigation. The Car speed was fixed to 55km/h, the pedestrian was placed in a walking position from the left to the right side of the car in order to be impacted on the right side of his body. A first hypothesis was made on the position of the legs. We decided to start this study with the left leg in the front and the right one in the rear.

This simulation provided good results with real indications in terms of impact areas and injuries except for the femur fractures. Tibia fractures were

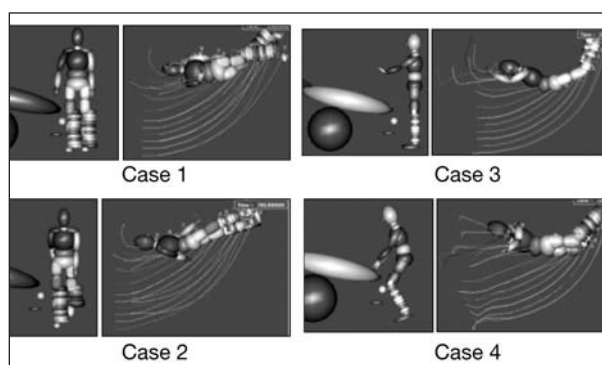

Fig. 6: Variation of the pedestrian kinematic with its position at impact

observed on the third superior part but not on the femur. In fact, 4 impacts during the simulated kinematic were observed: the lower leg on the bumper, the upper leg on the low bonnet, the shoulder on the high bonnet, the head on the windscreen.

Because femoral fractures were not retrieved, a parametric study based on this configuration was performed. Parameters concerned:

- the velocity of the car
- the position of the pedestrian at impact
- the pitch angle of the car during the braking phase

Several situations have been simulated. figure 6 shows four different kinematics corresponding to a variation of the pedestrian position at impact. In case one, the pedestrian is walking, in case 2 he is running, in case 3 he is standing in the front of the car and in case 4 he is crouching in the front of the car.

Obviously, the initial position of the pedestrian at impact has a huge influence on his cinematic. So, all simulations which were not in accordance with real indications were rejected. For example, the driver declared that he saw the face of the pedestrian coming towards the car so it was important to be in correlation with this declaration. Consequently, simulations were not retained if they did not give a face impact on the windscreen.

Some specific configurations such as case 3 or 4 have been tested in order to retrieve femur fractures. But even if the pitch angle of the car has been increased, no simulation has given this kind of result.

Finally, hypotheses were made on these fractures and they could be due to the fall on the pavement.

Real Bicyclist Accident

In-Depth Investigation

On an august day, at 3:10 p.m., the weather was clear, Mr X was driving his Peugeot 205 on a minor road linking his home to the nearest village when suddenly a young bicyclist emerged from a villa access on his left. Mr X braked in emergency in vain and could not avoid the bicyclist who was riding straight into him (see figure 7).

For this case, skid marks measured approximately 11m. The kinematics reconstruction gave for the car an approaching speed of approximately 55km/h and an impact speed of about 45km/h. The driver statement is in accordance with this result because he declared a speed of around 50km/h. Impact areas were observed on the left headlight, the left corner of the bonnet and on the centre of the windscreen (see figure 7).

The bicyclist was 13 years old. The bicycle impact speed is roughly estimated at 15km/h.

Injuries observed at the hospital were: cranial traumatism without blackouts located on the parieto-occipital right bone, 1/3 superior right fibula fracture, spiroid fracture of the 1/3 superior right tibia, wound at the medial condyle level on the right leg, left ear wounds, minor skin injuries at the level of the left elbow.

Relationships between injuries and impact areas were done in order to estimate a first configuration of the accident. Tibia and fibula fractures were associated with the impact on the left bonnet (and headlight), head traumatism with the windscreen impact and minor injuries on the left side with the fall on the ground.

Numerical Simulation

As it was performed for the pedestrian accident, modifications were applied on the multibody model

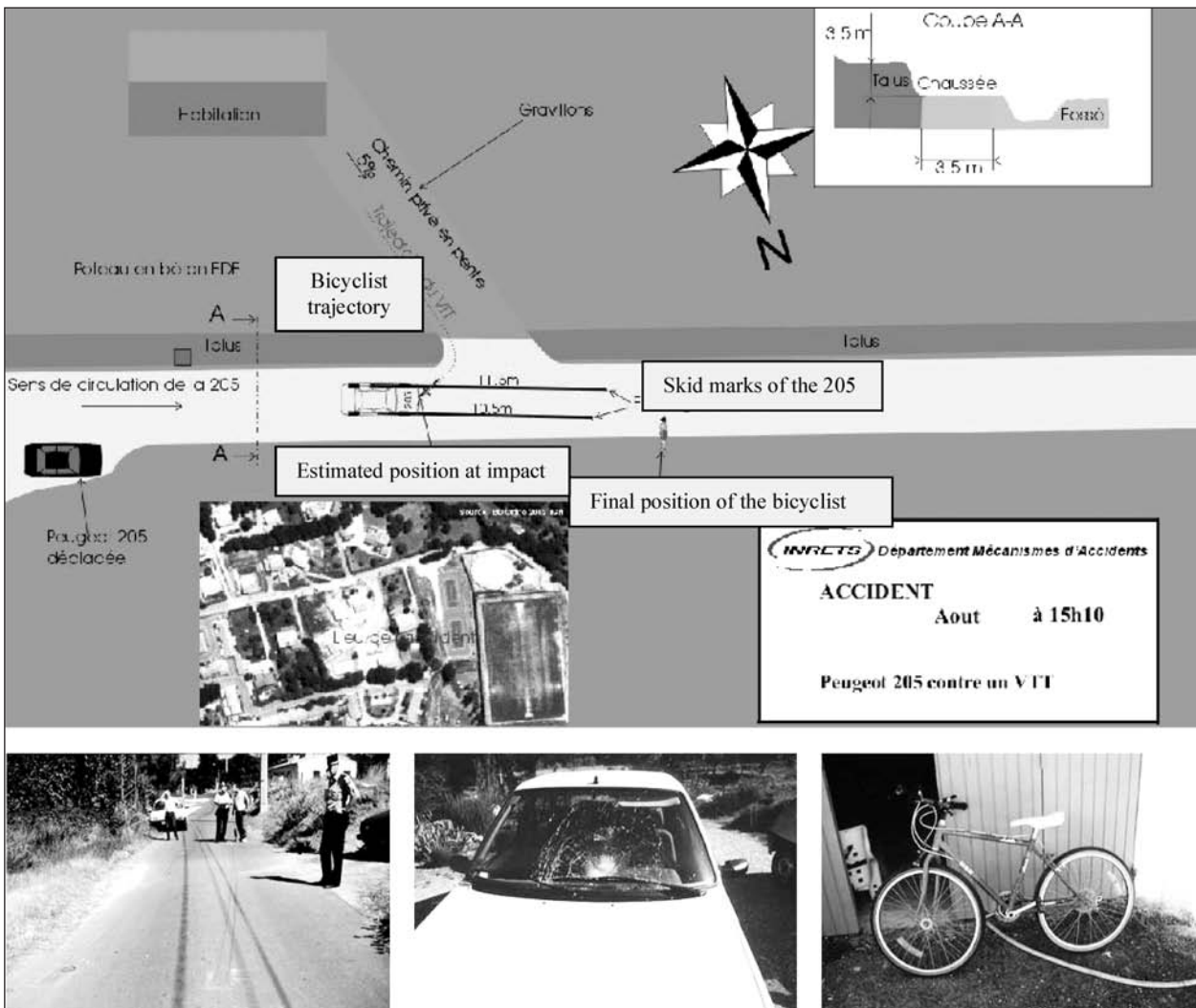

Fig. 7: In-depth investigation for the real bicyclist accident: plan, skid marks, impact points on the 205 and bicycle

to adapt it to the accident configuration. The human body model, the bicycle and the car front shape were modified with the help of clinical records or measurements collected by the investigators.

A parametric study was also performed for this case. Parameters variation concerned:

- the velocities of the car and the bicyclist
- the impact angle (see figure 8)
- the cyclist position on the bicycle

In this case, the orientation of the impact was the most difficult parameter to estimate because it completely changed the kinematic of the cyclist.

The retained configuration was the one which reproduced the same impact area and the same injuries. In particular, an angle of 30° was chosen for the impact orientation.

figure 8 illustrates in parallel, the main steps of this accident and the corresponding chronology. It was possible to decompose it into three phases which associate injuries and impact areas on the car: the right leg on the bumper, the right side of the head on the windscreen, fall to the ground on the left side. Such kinematics could explain injuries observed in the clinical records of the cyclist.

Concerning quantitative results, the multibody model gave information on the accelerations for each body segment (see figure 9). In particular we observed a tibia acceleration of 180g at the impact time of the knee on the headlight and a maximal acceleration of 140g was computed for the head during the impact on the windscreen. Because the head acceleration was “only” 60g during the impact on the pavement, this result confirmed the hypotheses of relationships between injuries and impacts expected during the accident analysis.

Discussion

The methodology of accident analysis presented here is an approach combining primary and secondary safety principles. It allows us to take advantage of both studies because they are complementary and closely linked.

Indeed, the primary analysis establishes first hypotheses on the configuration of the accident. In particular, it gives approximately the impact orientation and the speed of the car from simple mechanical equations (uniform decelerated movement). Moreover, in the case of accidents involving vulnerable road users, and more specifically pedestrians or cyclists, the in-depth investigation also enables us to associate injuries and impact areas with the car. This first estimation

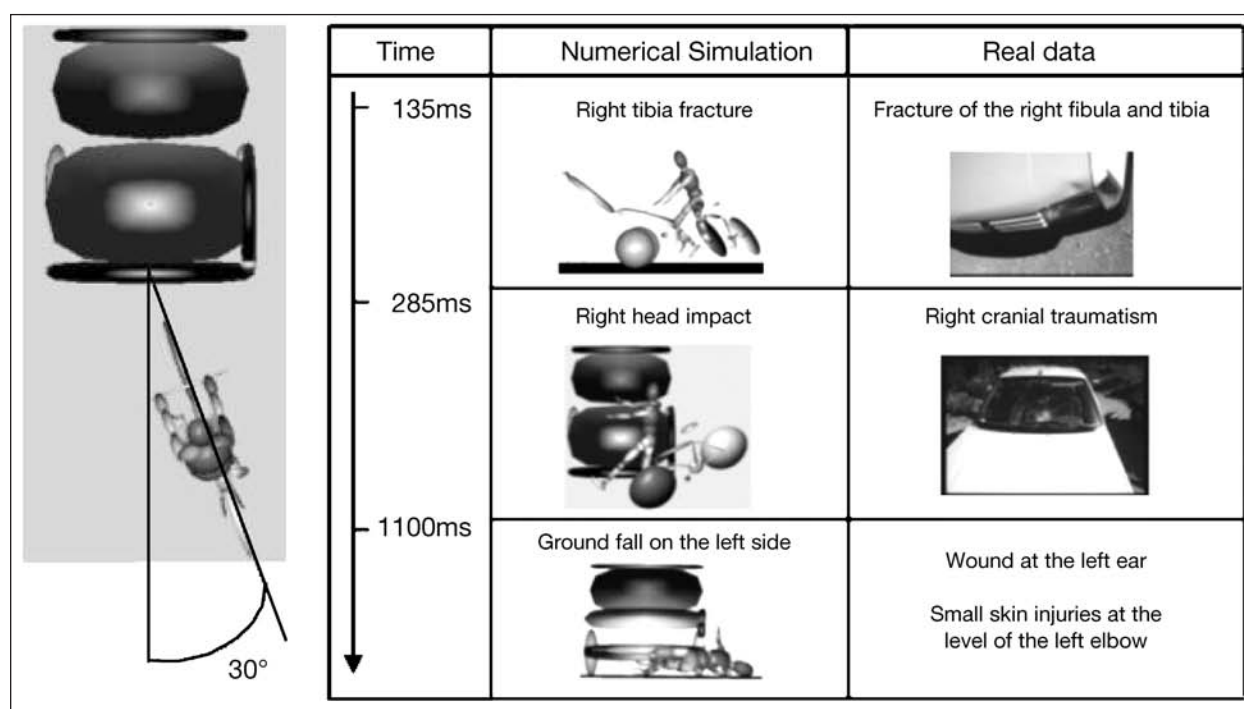

Fig. 8: Impact orientation and numerical simulation chronology

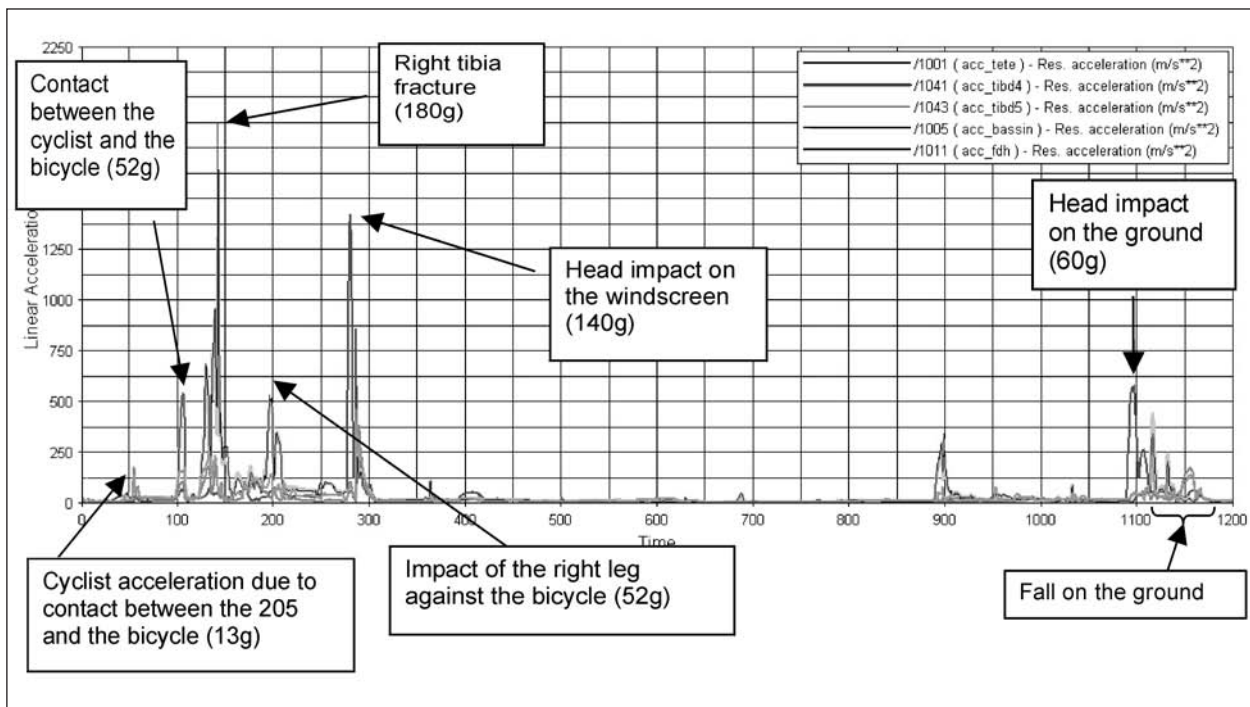

Fig. 9: Body segments accelerations during impact

of the accident parameters gives the input data for a parametric study during the secondary analysis.

This secondary analysis is based on numerical simulations using multibody models which are predictive of injuries. The advantages of such an approach are to be simplified in the modelling work in comparison with a finite elements method. In particular it allows a variation of some parameters because simulation times are very short. Relevant parameters can be the velocity of the car, the impact orientation, the initial position of the involved person... Results of simulation (injuries, contact areas...) are then compared to the real signs collected during the in-depth investigations. The simulation which provides best correlations is considered as the most probable configuration of the accident. So, the numerical simulation is in return validated by the primary analysis in terms of qualitative results.

Concerning quantitative results, it has been specified that the multibody model used in this study is valid for car velocity lower than 40km/h. Both accidents described here have been simulated with higher speeds and presented nonetheless good correlations with qualitative information. Consequently, it could be considered that the multibody model can be extrapolated for higher speeds and used for real accident reconstructions.

Then this multibody model could be used to evaluate the human body tolerance during a real accident. In particular, it gives information on the levels of accelerations and forces endured by the involved person. Finally, these results can be used to compare experimental tests performed in the biomechanical field and reality.

With regard to the kinematics of the pedestrian or the cyclist, this could be divided into five main contacts:

- the lower leg on the bumper,
- the upper leg on the low bonnet,
- the thorax on the high bonnet,
- the head on the windscreen,
- the fall on the ground.

In the cases detailed above, we observed some of these contacts and it was possible to quantify them in terms of chronology for example.

For the pedestrian accident, its configuration is close to that used for crash test with PMHS. Globally, good correlations can be observed between experimental results and reality except in the case of femur fractures. Because no femur fracture has been noticed during experimental tests with PMHS, we have deduced that these fractures are due to the fall on the pavement.

As far as the bicyclist accident is concerned, its configuration is not the same as the one used in PMHS tests. So we cannot compare real injuries with those observed in the laboratory but we could expect to perform an experimental test of the same configuration for it to be validated.

Conclusion

The aim of this research was to improve understanding of the vulnerable users accidents. In particular, one of the objectives was to obtain a better knowledge of the cinematic behaviour of the pedestrian (or the bicyclist) when impacted by a car. It is based on a comparison between real indications and numerical results. Globally we can consider that the kinematics and the injuries are similar for cases presented here.

More specifically, this methodology allows to quantify the kinematic in terms of acceleration levels for example. It enables also to better interpret the injuries mechanisms and to compare the reality with experimental tests performed in the laboratory.

This research is part of the framework of the French project APPA. The aim of this project is to evaluate the future automotive regulations in terms of pedestrian accidents.

This work will continue with a comparative study between pedestrian accidents and bicyclist ones with the aim to search if pedestrian safety countermeasures suggested or imposed on car manufacturers will be useful or not to bicyclists.

References

- 1 Observatoire national interministériel de sécurité routière, www.securiteroutiere.gouv.fr, 2003, 2003
- 2 B. KARGER, K. TEIGE, W. BÜHREN, A. DUCHESNE: Relationship between impact velocity and injuries in fatal pedestrian-car collisions, *Int. J Legal Med*, 113:84-88, Springer-Verlag, 2000
- 3 G. TERESINSKI, R. MADRO: Evidential value of injuries useful for reconstruction of the pedestrian-vehicle location at the moment of collision, *Forensic Science International*, 128:127-135, Elsevier, 2002
- 4 D. P. WOOD: Impact and movement of pedestrian in frontal collisions with vehicles, *Proc Instn Mech Engrs*, 202:101-110, British Library, 1988
- 5 J. EUBANKS, W. R. HAIGHT: Pedestrian involved traffic collision – Reconstruction methodology, SAE Technical paper #921591, pp. 1393-1409, 1992
- 6 F. FERRANDEZ et al.: L'étude détaillée d'accidents orientée vers la sécurité primaire. Méthodologie de recueil et de pré-analyse, Paris, Presses de l'École Nationale des Ponts et Chaussées, 1995
- 7 Y. GIRARD: In-depth investigation of accidents: the experience of INRETS at Salon de Provence, Salzburg, ICTCT Congress, 1993.
- 8 D. FLEURY et al.: In-depth investigation, FERSI Group report, Rapport INRETS/FERSI, 1994
- 9 P. van ELSLANDE: Classifying "Human errors" in road accidents, Tampere, Colloque IEA '97, 1997
- 10 C. CAVALLERO, D. CESARI, M. RAMET, P. BILLAULT, J. FARISSE, B. SERIAT-GAUTIER, J. BONNOIT: Improvement of pedestrian safety: influence of shape of passenger car-front structures upon pedestrian kinematics and injuries: evaluation based on 50 cadaver tests, SAE paper # 830624, pp225-237, 1983
- 11 J. K. YANG, P. LÖVSUND, C. CAVALLERO, J. BONNOIT: A human body 3D mathematical model for simulation of car-pedestrian impacts, *J Crash Prevention and injury Control*, Vol. 2 (2), pp. 131-149, OPA, 2000
- 12 E. GLASSON, J. BONNOIT, C. CAVALLERO, F. BASILE: A numerical analysis of the car front end module regarding pedestrian lower limb safety, *Vehicle Safety*, C567/016/2000, pp. 79-91, 2000
- 13 X. J. LIU, J. K. YANG, P. LÖVSUND: A study of influences of vehicle speed and front structure on pedestrian impact responses using mathematical models, *Traffic injury prevention*, 3:31-42, Taylor & Francis, 2002
- 14 T. MAKI, J. KAJZER, K. MIZUNO, Y. SEKINE: Comparative analysis of vehicle-bicyclist and vehicle-pedestrian accidents in Japan, *Accident Analysis & Prevention*, 35:927-940, Pergamon, 2003

- 15 D. LECHNER et al.: La reconstitution cinématique des accidents, Rapport de recherche INRETS n° 21, 1986
- 16 H. YAMADA:, Strength of biological materials, Baltimore, Williams & Wilkens, MD, 1970
- 17 J. KAJZER: Shearing and bending effects at the knee joint at low speed lateral loadings, SAE paper #1999-01-0712, 1999

J. K. Yang, J. F. Yao
Department of Machine and Vehicle Systems,
Chalmers University of Technology, Sweden

D. Otte
Hannover Medical School, Germany

The Dynamic Responses and Head Injury Correlations of Child Pedestrians Involved in Vehicle Accidents

Abstract

This study is aimed to investigate the correlations of impact conditions and dynamic responses with the injuries and injury severity of child pedestrians by accident reconstruction. For this purpose, the pedestrian accident cases were selected from Sweden and Germany with detailed information about injuries, accident cars, and accident environment. The selected accident cases were reconstructed using mathematical models of pedestrian and passenger car. The pedestrian models were generated based on the height, weight, and age of the pedestrian involved in accidents. The car models were built up based on the corresponding accident car. The impact speeds in simulations were defined based on the reported data. The calculated physical quantities were analyzed to find the correlation with injury

outcomes registered in the accident database. The reconstruction approaches are discussed in terms of data collection, estimating vehicle impact speeds, pedestrian moving speeds and initial posture, secondary ground impact, validity of the mathematical models, as well as impact biomechanics.

Introduction

Each year, about 1.2 million people are killed in road vehicle traffic collisions and more than 50 million injured worldwide. Huge economic losses and serious consequences result from these traffic accidents [1]. The road users like pedestrians, cyclists, motorcycle riders are exposed to a high risk of injury, of which the pedestrians are the most vulnerable road users and account for a large part of traffic casualties in collisions with motor vehicles. The studies in Europe [2-4] indicated that the passenger cars are most commonly involved in pedestrian accidents. Figure 1a shows a distribution of vehicle type in pedestrian accidents based on collected data from Swedish national accident database STRADA. The injury distribution according to different injury severity is shown in Figure 1b.

During the past three decades significant reductions in pedestrian fatalities have been achieved in Europe [5] and the United States [6]. This tendency is mainly due to improved traffic planning in built-up areas. Other safety programs

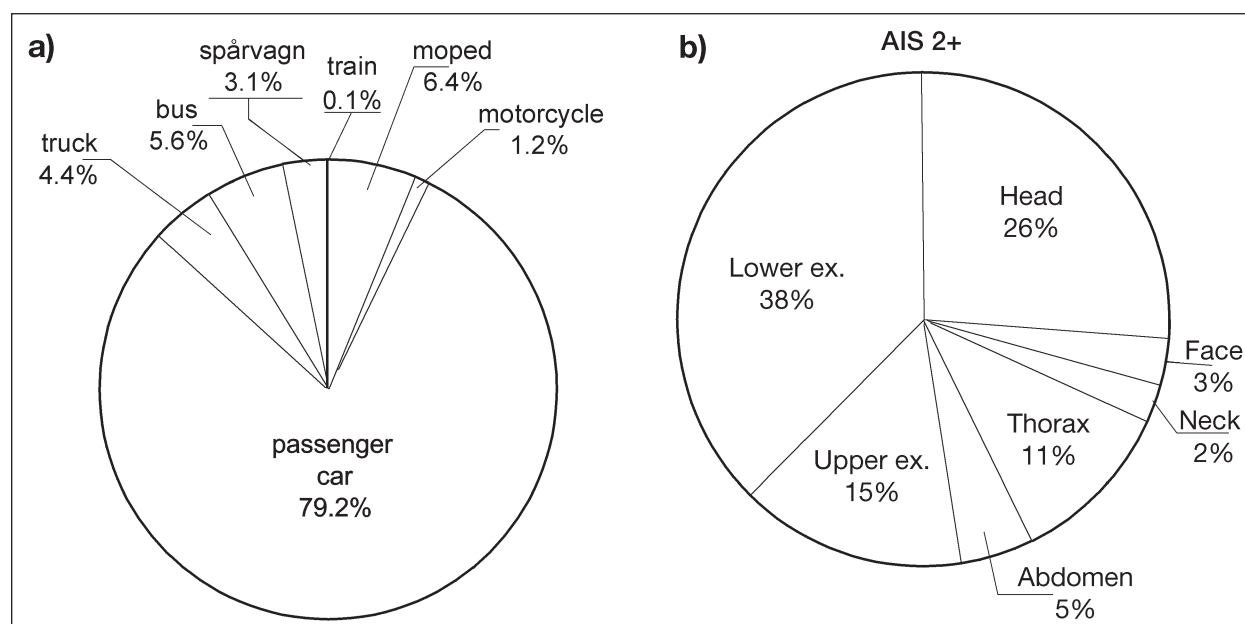

Fig. 1: (a) Involved vehicle type in pedestrian accident, and (b) Injury distribution in passenger car to pedestrian accidents

such as appropriate speed limits, drink driving control, education of young people could also contribute to the reduction of casualties. So far, there is not any statistical study to prove that injury reduction is caused by changes of car-front shape, but the findings from studies suggest that a potential benefit can be obtained from improvement of new vehicle designs which meet the EEC requirements.

The pedestrian accidents in road vehicle traffic have been extensively investigated world-wide in the past four decades to find solutions for pedestrian protection from vehicle collisions. A study on improvement of car front design requires detailed information about the dynamic responses and injury biomechanics of pedestrians, such as the loads to body segments, and injury related parameters that are usually missing even impossible to acquire in an in-depth field investigation. In order to get better understanding of kinematics and injury related physical quantities associated with pedestrian response to vehicle impacts, a large number of studies have been done by simulation or reconstruction of the collisions using post-mortem human subjects (PMHS) or mechanical/mathematical dummies. The correlation of pedestrian injuries observed in accidents with the biomechanical responses and injury related parameters has been determined by combining the knowledge from those studies.

This paper presents a study on pedestrian accidents with focus on detailed individual case analysis via accident reconstruction using the mathematical models. The objective of the study is to determine the correlations of impact conditions and dynamic responses with the injuries and injury severity of pedestrians from accident. The results were analyzed and the reconstruction approach in the study is discussed in terms of data collection, the basic variables, missed data elements, estimating vehicle impact speeds, pedestrian moving speeds and initial posture, secondary ground impact, validity of the mathematical models, as well as impact biomechanics.

In-Depth Accident Analysis

An ongoing study of pedestrian accidents is being carried out in co-operation between Chalmers and Hannover. In Sweden 2 child pedestrian cases were collected and an in-depth study was conducted via accident reconstruction with

mathematical models developed at Chalmers [7]. In Germany 69 child pedestrian accident cases were selected from the accident database GIDAS (German In-Depth Accident Study) documented by the Accident Research Unit at the Medical University of Hannover [8-9]. In the district of Hannover a representative sampling of accidents is carried out by order of the German Government (Federal Highway Research Institute BAST) in co-operation with the car manufacturers FAT [3]. For each collected case, complete information regarding pedestrians, vehicles, and crash environment was documented.

Injuries sustained by each pedestrian were coded either on the accident scene (if possible) or later in the hospital according to AIS 90 (AAAM, 1990). For a given body region which sustained more than one injury, only the single most severe AIS score was registered. The anthropometric data of the pedestrian such as age, gender, height, and weight were also documented in the hospital. Accident witnesses were investigated to obtain the accident information such as pedestrian posture, impact direction, etc. For the 69 children involved in the accidents, the initial posture at the moment of impact was determined as running, fast walking, walking or standing. figure 2 shows that half of the children were running but only 2% of the children were standing when they were hit by the vehicle. This is remarkable comparing to the situation of adult pedestrians. The accident data also showed that 87% of the children were impacted from the lateral direction.

The injury distribution of child pedestrian is shown in table 1. It was observed that the head and the lower extremities were the two most frequently

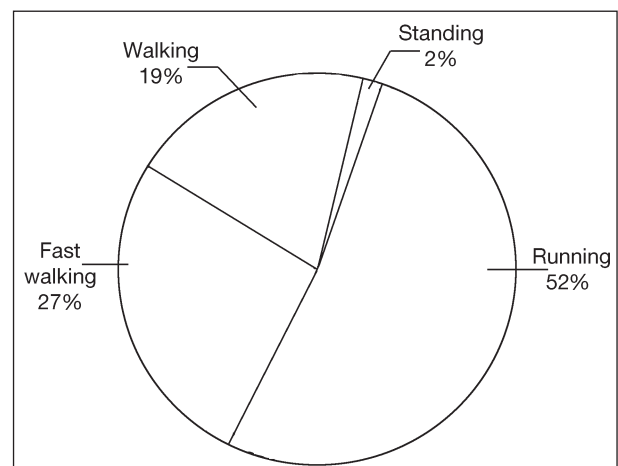

Fig. 2: Action of child pedestrian at the moment of impact

Body Region	AIS 1	AIS 2+	All Injuries
Head	25.8%	56.4%	33.1%
Neck	2.4%	0.0%	1.8%
Thorax	4.8%	7.7%	5.5%
Upper Extremities	23.4%	12.8%	20.9%
Abdomen	4.0%	0.0%	3.0%
Pelvis	11.3%	0.0%	8.6%
Lower Extremities	28.2%	23.1%	27.0%

Tab. 1: Injury distribution by body regions

injured body parts during the accidents. For AIS 1 minor injuries, head and lower extremity injuries accounted for 25.8% and 28.2% respectively. For AIS 2-6 injuries, head and lower extremity injuries accounted for 56.4% and 23.1% respectively.

The vehicles involved in the accidents were recorded with detailed information about passenger car makers, model, registration year, estimated impact speed. The selected cases were limited with accident car models introduced to the market after 1990. Thus these accidents reflect the most up-to-date child pedestrian accident characters. The deformation pattern, contact points on the car and characteristics of special traces on the road and on the car were measured and documented in a 3-dimensional x, y, z-coordinate system with reference to the longitudinal central line of vehicle. Pictures of impact location are documented and could be used for analysis. The final positions of the pedestrian, car and any other related features were also recorded. The collected data provided most important information to carry out the accident reconstructions.

In the present paper, 12 cases were presented to analyze pedestrian injury biomechanics and the correlation of impact conditions and biomechanical responses with the injury outcomes in the collisions.

Example Case 1: 7 Years Old Child-to-OPEL

Pre-Crash

A car-to-child pedestrian collision occurred on a secondary rural road in south Sweden. The accident car is OPEL Rekord Combi 1985 model. The driver claimed that he saw a group of children playing on the right side of the road from about 50 meters away (position A in figure 3a). When the car was approaching the group of children at speed about 70km/h, the driver lifted his foot from the

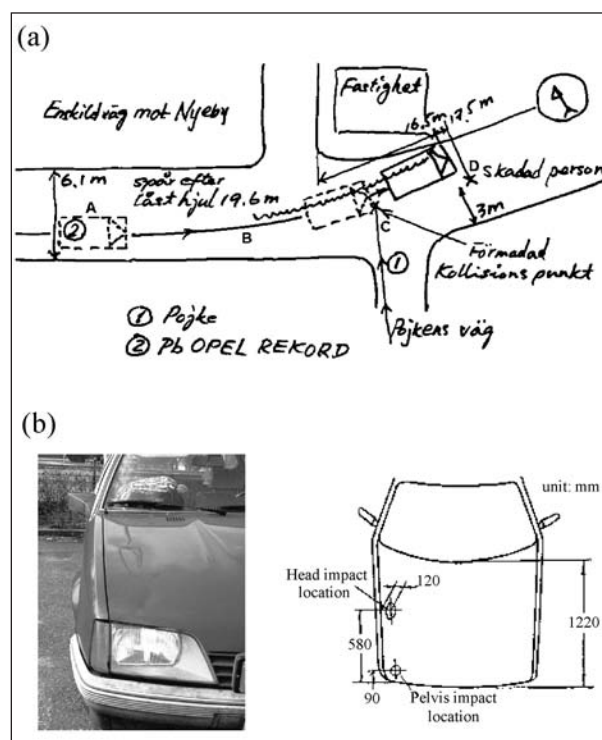

Fig. 3: Scheme of (a) accident scene, (b) the location of head and pelvis impact on hood top

accelerator as he noticed the potential risk. Then he began to brake slightly as the car was approaching the crossing. Suddenly a 7-year-old boy began running across the street when the car was arriving at position B. The driver braked hardly and manipulated the car to avoid an impact.

Crash

The car, however, still hit the child by the right front corner at position C and at an estimated speed about 40–45km/h. The car stopped about 10 meters away from C, and threw the child to position D (figure 3a).

Post-Crash Data

The injuries of the child pedestrian were identified and registered in hospital. The child sustained unconsciousness due to the head-brain injuries: fracture left orbit (AIS 3), subdural hematoma left frontal lobe (GCS 5, GOS 2, and AIS 5). Except some slight outer skin injuries in the lower extremities, no other injuries were reported. After 7 weeks the child could stand up but not walk.

The damage of the accident car and interactions between the car and body segments of the child were determined based on the police report. The

accident car suffered slight damage. The right headlight was broken. Two dents were found on the hood. The contact dents were visible on the leading edge of the hood and the hood top (figure 3b). The dent on the hood top was identified as the result of the head impact. It was about 580mm away from the hood edge and 120mm away from the right fender. Another dent caused by the pelvic impact, was about 90mm away from the hood leading edge. No evidence indicated the damage to the structures beneath the hood. The measured wrap around distance (WAD) was 1350mm. The throw distance was 14m from initial impact.

The available data are summarized in table 2 for reconstruction of the accident. It is necessary to mention here that some information for accident reconstruction is not possible to acquire from field investigation, such as the vehicle front stiffness, and kinematics of the pedestrian collision.

Example Case 2: 4 Years Old Child-to-OPEL Omega Combi 1994

Pre-Crash

A passenger car-to-child pedestrian accident happened in a residential area in Hannover, Germany. The accident car is an OPEL Omega Combi 1994 model. The car was traveling on a street where several vehicles were parking along one side (figure 4a). A 4-year-old boy walked fast from position A to cross the street. Because of the parked car, the driver could not see the boy in advance. After the driver saw the boy, he braked hardly but still hit the boy. The impact speed was about 25km/h.

Crash

The car hit the child by the left front part at position B. The boy was thrown away and the rest position was C. The throw-out distance was about 600cm.

Post-Crash Data

The child sustained AIS 2 head injury, AIS 1 lower extremity injury. On the vehicle, scraps on the bumper and dents on the hood were found as shown in figure 4b.

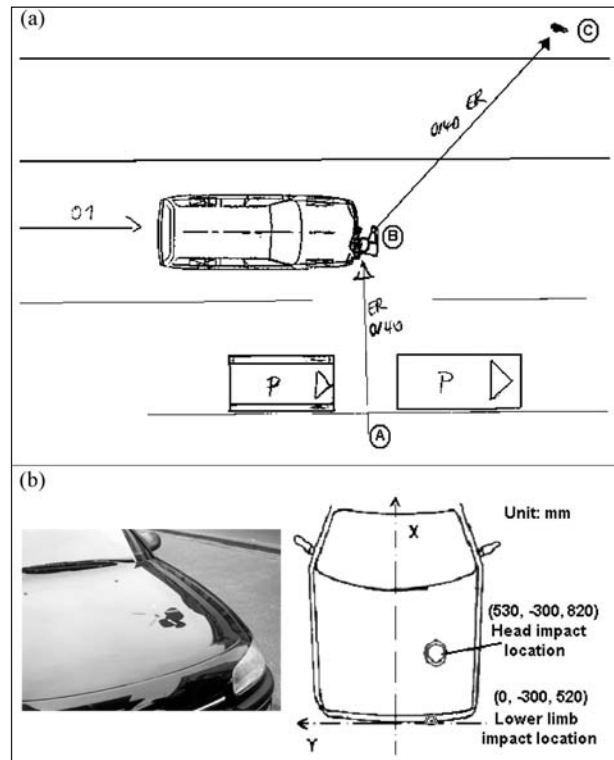

Fig. 4: Scheme of (a) accident scene, (b) Scraps and dents found on the accident vehicle

Pre-crash		Crash		Post-crash	
Vehicle		Vehicle		Pedestrian	
- Travel speed	estimated	- Impact speed	estimated	- Gender	Boy
- Pre-crash braking	yes	- Contact point	identified	- Age	7
Pedestrian		Pedestrian		- Height	estimated
- Initial posture	identified	- Kinematics	NA	- Weight	estimated
- Moving speed	estimated	Ground impact		Injuries	
- Orientation	identified	- Body contact	NA	- Injury patterns	identified
Road environment		Throw distance		- Injury distribution	identified
- Road type	rural road	- Landing point	NA	- Severity	AIS, GCS, GOS
- Road surface	asphalt	- Sliding distance	estimated	- Cause of injury	determined
- Weather condition	fine	- Resting point	determined	Vehicle	
				- Damage (dents, scratch)	identified
				Field information	
				- Skid mark	measured

Tab. 2: Summary of accident data collection for reconstruction in case 1

Accident Reconstructions

The selected accident cases are reconstructed using pedestrian mathematical models and passenger car models.

The geometry of the child models was generated based on the height, weight, and age of the pedestrians involved in the accidents. The characteristics of child models were scaled from a validated adult pedestrian model [10-11].

The anthropometric data of the pedestrian models used in the reconstructions were summarized in table 3, which was based on the data from the accident analysis.

The vehicle was modeled by a group of ellipsoids in MADYMO. The geometry of the vehicle models was obtained from the production drawings of the cars that had the same make, model and series as those involved in the accidents. The mechanical properties of the car models were defined in terms of stiffness properties acquired from EuroNCAP sub-system tests. The impact speeds of the cars and the pedestrian moving speeds were estimated based on the accident data, considering the car braking skid marks on the road surface and the pedestrian moving postures before the impact.

The kinematics were simulated in the reconstructions of the selected accident cases. The injury parameters in head, chest, pelvis and lower extremities were calculated to evaluate the injury severities from the accidents. The correlations of the output parameters from simulations with the injuries described in the medical and accident report were analyzed. The threshold of brain injury parameters, such as HIC and angular acceleration, was discussed based on reconstruction results.

Case No.	1	2	3	4	5	6	7	8	9	10	11	12
Age	7	9	12	4	7	6	6	6	5	6	4	8
Height (mm)	1230	1300	1200	1100	1200	1130	1200	1150	1200	1260	1100	1280
Weight (kg)	25	30.7	45	18	31	22	18	12	25	31	17	25

Tab. 3: Anthropometric data

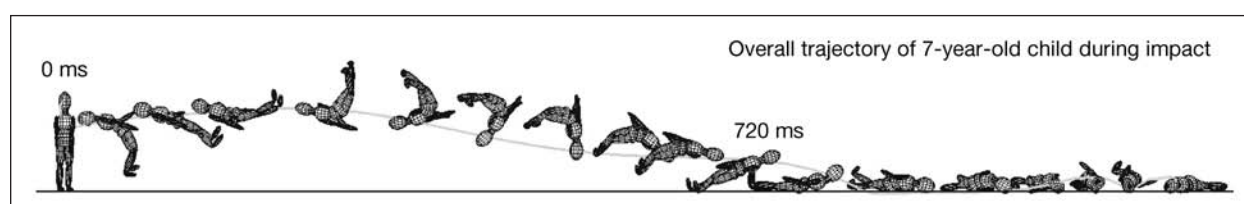

Fig. 5: Overall trajectory of 7-year-old child in collision with passenger car

The Set-up of Reconstruction Models

The reconstruction models were built up based on the complete information about the accident of each case. The configuration of the case 1 reconstruction model is described as an example as follows.

A mathematical vehicle model was developed based on the schematic drawing of OPEL Rekord Combi. The vehicle front structures were presented by four ellipsoids including lower bumper, bumper, hood edge and hood top as well. Several plans and ellipsoids were assigned to describe the outer surface and wheels. The force-deformation properties of the front structures were obtained from the sub-system test results of EuroNCAP. The friction coefficient between the wheels and road surface was assumed to be 0.7. The diving angle was assumed as 3 degrees. The steering effect was also simulated by defining an angular velocity of 1 rad/sec² about z-axis.

A 7-year-old child model was developed by using the scaling method from a validated adult model [10-11]. The initial posture was adjusted to be running in the direction perpendicular to the car moving direction. The running speed was estimated at about 10km/h. The friction coefficient between child body segments and road surface was based on empirical data, and was set at 0.6.

Results

Kinematics

Overall Kinematics of Child Pedestrian

Taking case 1 for example, figure 5 shows the overall trajectory of the 7-year-old child during the impact. The estimated vehicle travel speed was about 65-70km/h at the initial position (figure 3a),

and around 40km/h at the impact position. The simulated braking distance from the crossing to the vehicle rest position was about 16.1m (accident: 16.5m), and the child total throw distance was around 13.5m (accident: 14m). Both were close to the information collected by the police.

Head impact occurs at around 60ms after the initial contact. The head impact location is 570mm (accident: 580mm) away from the hood leading edge and 120mm (accident: 120mm) away from the right fender.

Head Impact Conditions

The child head impact conditions to the car front were determined for each case in terms of head impact location, resultant impact velocity relative to the car, head impact angle relative to the horizontal, as well as timing of head impact.

The contact location of the head on the vehicle could be defined by the wrap-around distance (WAD) along the car-front surface. Results from accident reconstructions show that the WAD ranged from 93 to 119cm (table 4). This WAD would usually make the head to hit the hood top. The WAD is greatly influenced by the pedestrian height. To eliminate the influence of the pedestrian body size, the ratio of the WAD to the pedestrian height was calculated. The statistics analysis shows that the average value of WAD to the pedestrian height ratio is 0.927 with a standard deviation of 0.072. Usually,

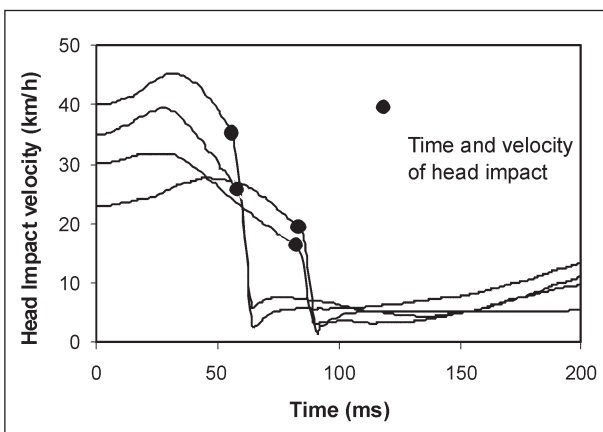

Fig. 6: The time history of head resultant velocity with respect to car front

in the child pedestrian accident, the WAD could be regarded as the length from the head centre to the foot.

4 reconstructed accident cases were selected since the children involved had the same height of 120cm. figure 6 illustrates the time history of the head resultant velocities of these 4 child pedestrians. For children at the height of 120cm, the head impact timing varies from 56ms to 83ms (figure 6). The results indicated that the head impact timing varied in a wide range due to vehicle speed.

The head impact speed appears to be proportional to the vehicle impact speed as shown in figure 7. Normally, the child head impact speed is lower than the vehicle travel speed at the moment of impact.

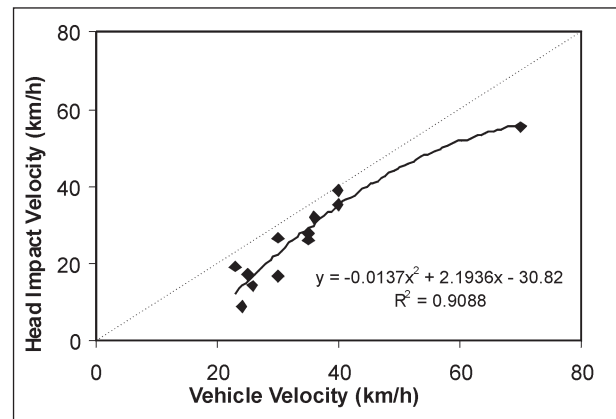

Fig. 7: Relationship between head impact speed and vehicle speed

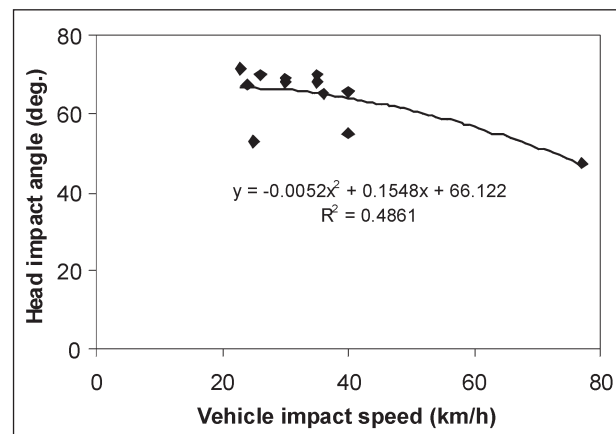

Fig. 8: Relationship between the vehicle impact speed and head impact angle

Case No.	1	2	3	4	5	6	7	8	9	10	11	12
Height (mm)	1230	1300	1200	1100	1200	1130	1200	1150	1200	1260	1100	1280
WAD _R (mm)	1306	1364	1000	970	1090	1030	1040	1120	1110	1190	930	1180
WAD _R /Height	1.06	1.05	0.83	0.88	0.91	0.91	0.87	0.97	0.93	0.94	0.85	0.92

Tab. 4: Correlation of WAD distance with child pedestrian height

The head impact angle could be greatly influenced by several factors such as the pedestrian height, hood edge height, hood angle and impact speed. A statistics analysis of the simulation results shows that the average impact angle is 64° with a standard deviation of 7.8° . The individual contribution of each factor to the head impact angle should be investigated using more detailed parameter studies. Figure 8 shows the relationship between head impact angle and vehicle velocity. The results showed that the head impact angle usually decreases with the increasing of vehicle impact speed.

Calculated Injury Parameters

The head injury risks were evaluated by calculating HIC, head angular acceleration and head angular velocity. Other calculated injury parameters, such as 3-ms clips of resultant thorax and pelvis accelerations, femur and tibia lateral accelerations, were summarized in Table 5.

The relative importance of ground and vehicle in causing the head injury is investigated in terms of HIC ratio β which is defined as follows:

$$\beta_{HIC} = \frac{HIC_{car-impact}}{HIC_{ground-impact}} \quad (1)$$

Table 5 shows that during the second impact, it could be the head or other body parts that first land on the ground. If the head first lands on the ground, there is a high probability that the HIC ratio would be smaller than 1.

The relationship between head injury severity and vehicle impact speed is shown in Figure 9. A nonlinear correlation is achieved by a second-order polynomial curve.

The correlation between the head injury severities in the accidents and the calculated injury parameters was investigated. Table 5 shows that the HIC value could be a good indicator for child pedestrian head injury. However, to establish the correlation of head injury risk with the HIC value, more accident cases are needed.

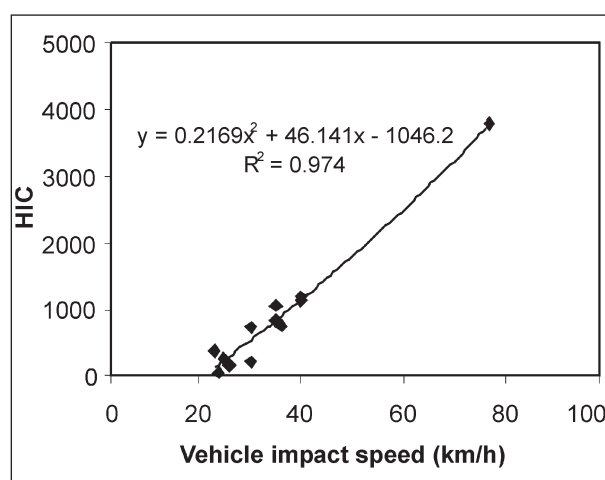

Fig. 9: Correlation of vehicle impact speed and HIC

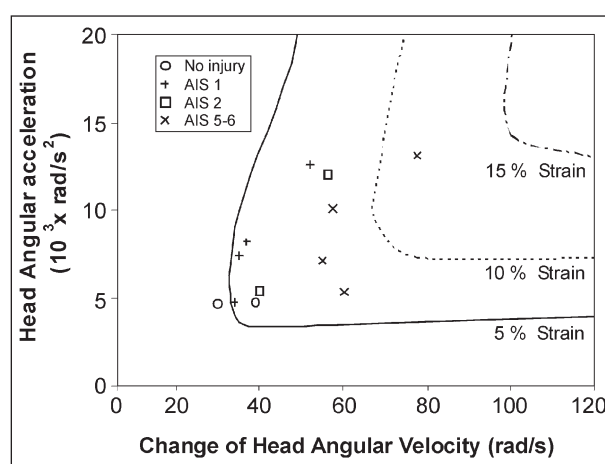

Fig. 10: Correlation of head injury severity and head angular motion

Case No.	1	2	3	4	5	6	7	8	9	10	11	12
Vehicle speed (km/h)	40	36	23	35	30	24	35	77	40	26	25	30
HIC _{car-impact}	1147	764	367	1041	227	58	851	3788	1182	166	263	725
HIC ratio	1.23	1.10	1.11	1.03	0.51	0.10	1.08	0.77	1.14	0.89	0.33	0.99
Head ang. acc. (rad/s ²)	7135	5293	8200	12003	4755	4770	12620	13060	10075	4679	5435	7384
Head ang. vel. (rad/s)	55	60	37	56	39	34	52	78	58	30	40	35
Thorax acc. (g)	43.9	24.8	53	46	33	31	45	144	57	18	31	35
Pelvis acc. (g)	104.7	62.0	58	93	59	67	90	271	162	50	82	83
Femur lateral acc. (g)	107.1	96.9	61	100	128	84	94	709	144	71	95	91
Tibia lateral acc. (g)	95.2	101.8	69	105	146	93	101	877	154	97	110	93
Landing body part	Foot	Foot	Head	Foot	Foot	Head	Foot	Head	Foot	Head	Head	Head
Head injury (MAIS)	5	5	1	2	0	1	1	6	5	0	2	1

Tab. 5: Calculated injury parameters from accident reconstructions

In the accident, the head of the pedestrian usually had a rotational motion. The skull will stop rotation quickly when the head hits the stiff bonnet. However, due to inertia the brain will continue its movement and rotate relative to the skull, which causes a strain of the brain. figure 10 shows the tolerance curves for 5% strain, below which the should have no axonal injury, and 10% critical strain, below which mild injury could be expected and above which DAI could be expected [12]. figure 10 shows most AIS 1 and none head injuries are below or around the 5% strain curve. The AIS 5-6 head injuries are around 10% strain curve. The results show that the rotational motion is another important indicator for the head injury.

Discussion and Conclusions

Pedestrian accident reconstruction is an important approach in the crash safety field for investigation of vehicle-pedestrian impacts. The dynamics, injury biomechanics of the pedestrian collisions are somewhat different from that of vehicle-vehicle impacts. In this study efforts have been made to find the correlation of the calculated biomechanical responses of pedestrian body segments with the corresponding injuries observed in accidents, as shown in the calculated results from reconstructions of children pedestrian accidents. The reliability of the findings from accident reconstructions is dependent on the quality of data sources, including information about three aspects: impacting vehicles, pedestrians, and road traffic environment.

Data Sources and the Basic Variables

The accident data used in these studies were collected from hospital clinical record and police report, which contributed to form national databases. This study was carried out based on the databases for acquisition of detailed information about causation and occurrence of accidents, injury patterns, causation and distribution of the injuries. The documented information forms firm background for the in-depth study on impact biomechanics and injury correlations of child pedestrians in vehicle collisions.

Estimating Vehicle Impact Speeds

The vehicle impact speed is one of the most important issues to investigate the pedestrian

impact responses and injury biomechanics. There are various approaches to estimate the vehicle speed at the moment of the collision. In the present study the following techniques were used to estimate the vehicle impact speeds based on available accident data such as skid marks and pedestrian throwing distance [4]. The vehicle impact speed can be determined also by simulation of vehicle and pedestrian motions.

Vehicle Speed Based on Skid Marks

Calculation of vehicle speed by using skid marks is the most common way in pedestrian collision analysis, in the case of accident vehicle skidded after an emergency braking. The length s of the skid marks can be measured in field investigations. For determining the passenger car speed in example case 1, the skid marks were registered about 11–14.5m long. The possible car impact speeds V_i are calculated using equation as follows:

$$V_i = \sqrt{2g\mu s} \quad (2)$$

Where the $\mu = 0.6 \sim 0.7$, the $V_i = 41 \sim 44\text{km/h}$. It is necessary to point out that there could be some difference of the calculated speed from the speed in real world accident due to the effect of pedestrian mass and road surface conditions.

Vehicle Speed Based on Pedestrian Throw Distance

The skid marks are not always available in accident field. One of the reasons is due to the increasing use of anti-lock brake systems, so skid marks are less common. The pedestrian's total throw distance is another indicator of the speed of the vehicle at impact. Estimating vehicle speed by pedestrian throw distance is thus becoming more important in accident investigations. The vehicle impact speed can be estimated by simulation of the vehicle and pedestrian motions.

Pedestrian Initial Posture and Moving Speeds

In the real world vehicle-pedestrian accidents the initial posture of a pedestrian at an impact is varied in different motion attitude. Therefore an appropriate initial position should be investigated and defined for reconstruction of the pedestrian accidents. According to the present study, the child pedestrian initial posture in an accident is summarized as follows.

- In car-pedestrian accidents, the pedestrians are often struck from the side by the front structure of a vehicle when crossing a street. In this study, it was found that in 87% of the cases the pedestrians were hit from the side.
- The majority of 98% of the child pedestrians are in motion during impact, either walking or running. This indicated a remarkable difference from the study on initial posture of pedestrians in all age groups, of which 79% are in motion [13].
- For the walking position, it was proposed to take into account the leg orientation. During the pedestrian impact the kinematics and dynamic loading of the pedestrian are not the same if you have the left leg forward or the right leg forward.
- The impact responses and injury outcomes are significantly affected by the initial postures and the orientation of body segments.

The moving speed is another important variable to define in accident reconstruction. The child normal crossing speeds were established as 1.5m/second to 2m/second, which are recommended to be used in present study.

Secondary Ground Impact

In reconstruction results the HIC values were calculated in both first contact with the car and second contact with the road surface. In the 6 cases it is the head landing on the ground first during secondary impact. In the 6 cases it was other body parts landing on the ground first. It is usual that the HIC value in contact with the car front is larger than that in the second ground impact without the head landing on the ground first. The reverse is the case for the second ground impact with the head contacting the ground first. It indicated that the contact modes in secondary ground impact are complicated, which could be dependent to the vehicle front shape, impact velocity, and body size.

Validity of Mathematical Models

There are large differences between child and adult due to the variability of body size, mass distribution, characteristics of the developing body structures, and injury tolerance levels. The child models can be developed using available anthropometry data and existing software such as the MADYMO-GEBO program, according to age, body height and/or body weight of the desired

human model. However, limited knowledge is available for the characteristics of the developing body structures such as head, vertebra column and lower extremities of children. In the present study, a scaling method was used to develop the multi-body mathematical models [11].

The joints properties and contact stiffness of body segments are the essential input data for the models. The lateral flexion properties of neck, thoracic, lumbar, hip, knee and ankle joints were considered as the key issues for the dynamic responses of the child pedestrians involved in traffic accidents, because the majority of child victims are struck from side by vehicles. Based on the analysis of the behavior of the functional unit for the lumbar vertebrae and the knee joints under lateral flexion mode, the simplified joint model was developed to derive the scale factors of lumbar vertebra and knee joints.

For the lateral contact stiffness of long bones, the three-point bending model was used to calculate the scale factors from adult data. Without geometric data for long bones, it was assumed that the outer diameter of long bones is proportional to the circumference of the corresponding body part. For example, the diameter of tibia bone is based on the circumference of lower leg. It was found that the contact stiffness of a long bone depends on the cross-section, length and the elastic modulus of the bone as well. The scale factors for the thorax and head were adopted from the available biomechanical study, respectively.

Child accident reconstruction is a feasible way to evaluate the effectiveness of the scaled children models. The reconstructions provided results for the overall motions of pedestrians, the throwing distances, the head linear and angular accelerations, HIC, the head impact velocities and angles, the head contact locations and timing on the car front structures. The calculated head angular accelerations are associated with brain injuries and within the reported brain injury tolerance corridor (figure 10). The results of accident reconstructions indicated the capability of the scaled models to predict the dynamic responses and injury severities of child pedestrians under impact loading.

Impact Biomechanics

Accident reconstructions by using mathematical models are the most efficient way to find the

correlation of the injuries with physical parameters which resulted in the body damages in an accident.

It was found that the injury distribution of pedestrians varies with the body size. For the children under 6 years old, the chest and pelvis areas are exposed to high injury risks and the older children sustain more severe injury in head and lower extremities.

In the 9-year-old child case the HIC was 764 lower than the proposed tolerance level, however, head angular acceleration was above the proposed tolerance level. This correlated to the fact that this 9-year-old child also suffered the severe brain injury without skull fracture.

The HIC and brain strain caused by rotational motion are two important measurements of the head injury. The suitable threshold for head-brain injuries should be further investigated by collecting more accident data with very detailed information about causation of accidents and injuries.

Conclusions

Head injury risk in child pedestrian accident was examined based on accident investigation and reconstructions. The results showed that the head is most frequently and severely injured in car to child pedestrian accidents.

The head impact conditions such as impact velocity, impact timing and angle, wrap around distance are mainly dependent on the car front shapes, and size of the child pedestrian.

The head injuries caused by car front structures were usually more severe than those caused by the secondary ground impact.

The impact velocity and car front structures have a significant influence on the kinematics and injury severity of the child pedestrian head. By limiting the vehicle speed and improving the car front design, the head injury severity of the child pedestrian could be reduced.

The dynamic responses and injury parameters from accident reconstructions would provide complement knowledge to develop safety counter-measures and protection devices.

The using of well documented real accidents as given by GIDAS allows a good possibility for further development of computerized human models for simulation and accident reconstruction.

References

- 1 World Health Organisation (2004): World Report on Road Traffic Injury Prevention, ISBN 92 4 156260 9, World Health Organisation, Geneva
- 2 EEVC (2002): Improved Test Methods to Evaluate Pedestrian Protection Afforded by Passenger Cars. EEVC Working Group 17
- 3 OTTE, D., KRETTEK, C., BRUNNER, H., ZWIPP, H.: Scientific Approach and Methodology of a New In-Depth-Investigation Study in Germany so-called GIDAS, ESV-Paper Nagoya Japan 2003
- 4 OTTE, D.: Use of Throw Distances of Pedestrians and Bicyclists as Part of a Scientific Accident Reconstruction Method, SAE paper 626, Detroit 2004-06-30
- 5 CARE - Community Database on Accidents on the Roads in Europe, http://europa.eu.int/comm/transport/home/care/index_en.htm, 2004
- 6 FARS- National Highway Traffic Safety Administration's (NHTSA): Fatality Analysis Reporting System (FARS) Web-Based Encyclopedia, <http://www-fars.nhtsa.dot.gov/>, 2004
- 7 YANG, J. (2003): 'Effects of Vehicle Front Design Parameters on Pedestrian Head-Brain Injury Protection', The 18th ESV Conference 19-22 May, 2003, in Nagoya, Japan
- 8 OTTE, D.: Severity and Mechanism of Head Impacts in Car to Pedestrian Accidents, Proc. Int. IRCOBI Conf. Biomechanics of Impact, 329-341, 1999
- 9 OTTE, D.: Severity and Mechanism of Head Impacts in Car to Pedestrian Accidents, Proc. of Int. IRCOBI Conf. Biomechanics Impacts, 1998, pp. 329-341
- 10 YANG, J. K., LÖVSUND, P., CAVALLERO, C., BONNOIT, J.: A Human-Body 3D Mathematical Model for Simulation of Car-Pedestrian Impacts, Journal of Crash Prevention and Injury Control, 2000, 2 (2):131-149
- 11 LIU, X. J., YANG, J. K.: Development of Child Pedestrian Mathematical Models and Evaluation with Accident Reconstruction, Traffic Injury Prevention, 2002, 3 (4):321-329

- 12 RYAN, G. A., VILENIUS, A. T. S.: Field and analytic observations of impact brain injury in fatally injured pedestrians. In: Proceedings of the Head Injury_94 Conference, Washington, DC, sponsored by US National Highway Traffic Safety Administration and George Washington University, 12–14 October, 1994, pp. 181–188
- 13 YANG, J. K., RIES, O., SCHOENPFLUG, M., BRIANSO, C. (2003): Pedestrian Position Definition. EU-HUMOS2 project report, 2CHA-030928-E1-DB

B. Lorenz
Federal Highway Research Institute (BAST),
Passive Safety & Biomechanics,
Bergisch Gladbach, Germany

R. Sferco
Ford Motor Company, Vehicle Safety, Automotive
Safety Office (ASO), Köln, Germany

”Whiplash“ Testing and Assessment – Summary of Current Activities in Europe

Abstract

This paper aims to present a comprehensive summary of current activities of how “whiplash” testing and assessment is addressed in Europe by various institutions and consumer organisations such as:

Folksam/SNRA, Thatcham/IIWPG, ADAC, ACEA, Euro NCAP and EEVC WG 20.

Introduction

The comparison of major accident samples from the German motor insurers shows that the incidence of cervical spine injuries (also denoted as whiplash injuries, cervical spine distortion injuries, CSD, or whiplash associated disorders, WAD) in motor vehicle accidents has almost doubled in the last 20 years (HELL 1999 [1]). MORRIS and THOMAS (1996 [2]) also show similar figures from UK. Swedish insurance data show that the risk of whiplash injuries leading to long-term disability is found to have doubled comparing recent car models with car models introduced 20 years ago (FOLKSAM 2001 [3]), and do to date in Sweden account for nearly 60% of injuries leading to long-term disability (KRAFFT 1998 [4]). The main public health problems concerning WAD are those leading to long-term disability. Between 5-20% (depending on accident data source and definition of long-term injury) of all cases will end as long-term cases, these few long-term cases are responsible for a majority of the costs (SPITZER et al. 1995 [5]). Since most impacts lead to no injury or to temporary symptoms, the duration of symptoms needs to be separated in order to isolate representative crash conditions in which more long-lasting whiplash injuries occur.

A Swiss study on CSD in cases with long sick leave times showed that a history of neck injury (pre-existing damage or pre-existing signs and symptoms) has a significant influence on the overall assessment (SCHMITT et al. 2002 [6]).

The assumed socio-economic losses for rear-end collisions in Germany (calculated after German Injury Cost Scale) would amount up to 1100 Million € for the year 1990 in the Federal Republic of Germany (West). At that time in about 54% of all car-to-car accidents with personal injury the accident pattern had been a rear-end collision. An estimation based on the insurance statistics in Germany came to about 200,000 reported cervical spine injuries after rear-end collisions for the year 1990 only in former Western-Germany. For 2000 a higher amount of 2 Billion € for Germany can be assumed because of increased incidence (HELL et al. 2001 [7]) and the inclusion of former East Germany. Estimations of annual costs from other countries regarding whiplash injuries were also very high:

- USA, 10 Billion US\$ (IIHS)
- UK, 800 Million Pounds (Direct Line)
- Canada, British Columbia/CDN 270 Million US\$ (ICBC)
- European Union, roughly at least 10 Billion € (Whiplash 1)

The medical and societal consequences of neck injuries due to rear impact are very important and the neck injury risk is the highest with this type of impact (see for example MURRAY et al. 1993 [8] and KRAFFT 1998 [4]). The Institute for Vehicle Safety, Munich, has established a large accident material of 15,000 car to car crashes representing every fifth collision from one year in Germany. A sub sample of 517 rear-end collisions with passengers suffering from cervical spine distortion (CSD) injury had been analysed technically and medically. From the accident reconstruction a typical accident scenario was evaluated, which should define requirements for improved seat/head-restraint systems and proposes to set up a dynamic seat test standard, which should be integrated in existing safety crash tests. The data material show that the typical accident configuration is a 0+/-5° angled impact with almost full overlap and a delta v between 10 and 20km/h. Comparable results were found in an independent

MHH Hannover accident investigation on behalf of VW (TEMMING 1998 [9]).

Females tend to have a higher injury risk compared with males (risk factor: small neck circumference) (HELL et al. 1999 [1], MAAG et al. 1993 [10], KRAFFT 1998 [4], YDENIUS and KULLGREN 2001 [11], BERGLUND 2002 [12]).

Especially the risk of permanent disability was four times higher for females than for males in the rear seat (KRAFFT et al. 2002 [13]).

In Germany, females show a higher injury occurrence ($\times 1.4$ in GDV investigations, $\times 2.0$ in VW investigations (Final report Whiplash I 2003)). Older people showed an increased risk for higher level CSD injuries (Final report Whiplash I 2003).

VIANO (2003 [14]) points to the importance of seat stiffness and torso mass in the early neck responses and differences between male and female related to whiplash.

The dynamic behaviour of seat backs seems to influence the risk of WAD. Stiffer seat backs produce higher risk of WAD (HELL et al. 1999 [15], PARKIN et al. 1995 [16], FORET-BRUNO et al. 1991 [17]). A low positioned head-restraint increases injury frequency, even compared with seats with no HR (HELL et al. 1998 [7]).

The risk of CSD rises with decreasing car mass and increasing opponent mass (EICHBERGER 1996 [18], RYAN 1993 [19], OLSSON et al. 1990 [20], KRAFFT 1998 [4]). Differences in mass reflect differences in change of velocity. A correlation between change of velocity and risk of both long-term and reported WAD has been shown (KRAFFT et al. 2001 [21]). Furthermore it has been shown that cars with similar weights may have large differences in risk of WAD (KRAFFT 1998 [4]), indicating that other factors than mass, such as car

structure and seat stiffness, are strongly influencing the risk of WAD.

Influence of crash severity or change of velocity for reported whiplash injuries have been presented in several studies. German figures show for rear-end collisions an average value of 15km/h. Results from FOLKSAM have been presented where crash severity, recorded with crash pulse recorders, have been correlated to injury risk (KRAFFT et al. 2001 [21] and 2002 [22], KULLGREN et al. 2003 [23]). However, only a few car models of one car make were involved. Average change of velocity and mean acceleration for occupants reporting a whiplash injury was found to be 14km/h and 4,4g respectively, while occupants not reporting an injury had corresponding values of 7,7km/h and 3,0g, see table 1.

Neck injury has been studied both with respect to duration of WAD symptoms and to different grades of WAD, according to the Quebec Task Force (SPITZER et al. 1995 [5]), versus different crash severity parameters (KRAFFT et al. 2002 [13]). Crash severity was found to have a large influence on the duration of symptoms. Also grades of WAD were directly correlated to crash severity. Acceleration was found to be more important in explaining the risk of whiplash injury than change of velocity, indicating that when designing a crash test, focus should also be set on acceleration. It was also found that no one in the sample had WAD symptoms for more than 1 month as long as the mean acceleration was below 3g. This finding is also supported from several volunteer tests (Mc CONNELL et al. 1995 [24], ONO and KANEOKA 1997 [25], SIEGMUND et al. 1997 [26]).

In the study by KRAFFT et al. (2002 [13]) the average change of velocity and the mean acceleration for those occupants with symptoms

Injury classification	Category	Number of occup.	Delta-V (km/h)	Mean acc. (g)	Peak acc. (g)
All		94	10.4 +/- 2.0	3.6 +/- 0.3	7.9 +/- 0.7
Reporting	No reported neck injury	53	7.7 +/- 1.2	3.0 +/- 0.3	6.7 +/- 0.7
	Reported neck injury	41	13.9 +/- 2.6	4.4 +/- 0.4	9.5 +/- 1.0
Duration of symptoms	Symptoms < 1 month	26	10.3 +/- 2.1	3.9 +/- 0.5	8.7 +/- 1.3
	Symptoms > 1 month	15	20.0 +/- 4.8	5.3 +/- 0.6	10.8 +/- 1.4
Grade of WAD (Quebec Task Force)	WAD Grade 0	53	7.7 +/- 1.2	3.0 +/- 0.3	6.7 +/- 0.8
	WAD Grade 1	20	10.1 +/- 2.3	3.9 +/- 0.6	8.6 +/- 1.5
	WAD Grades 2 and 3	18 (13+5)	16.2 +/- 3.8	4.8 +/- 0.6	10.1 +/- 1.5

Tab. 1: Average values in crash severity for different injury classifications and categories for rear-end car collisions with 4 car models from one manufacturer, model year 1995-2001 (from KRAFFT et al. 2002 [13])

more than 1 month, were found to be 20km/h and 5.3g respectively. The average peak acceleration was approximately 11g. Regarding different grades of WAD, occupants classified as WAD Grade 2 or 3 were found to have values of 16km/h, 5g and 11g.

Injury risk versus change of velocity and mean acceleration has also been compared to duration of WAD symptoms as well as to different grades of WAD (KRAFFT et al. 2002 [13]). When designing a crash pulse for crash testing, the crash recorder results suggest that acceleration should typically be between 5 and 7g for 80ms to represent occupants with symptoms more than 1 month.

Test Methods Based on Real World Accident Data

To test the utility of the previously discussed test criteria and parameters taken to evaluate different seat/head-restraint constructions, proposals of dynamic sled test programmes or standards have been developed and are described below.

FOLKSAM/SRA Test Series 2003 and 2004

In total two test series have been conducted by FOLKSAM/SRA using car seats on a sled. The first one in 2003 included 13 driver seats and the second test series in 2004 included 13 additional seats. In addition to that one seat with and without after market whiplash protection were tested according to the test procedure 2004. All seats were mounted at a test sled. The crashes were made at three crash severities to measure the protective effect at several crash conditions. Based on the results from crash recorders described above, 3 test conditions at different velocity and acceleration were chosen, 4.5g represents low risk but where many crashes occur, 5.5g represents medium risk and medium exposure, while 6.5g represents high risk but low exposure (cf. table 2).

The crash pulses of the two test series, 2003 and 2004, are presented in figures 1 and 2. The 2nd test

Test	Speed	Mean acceleration
1 – Low severity	16km/h	4,5g
2 – Mid severity	16km/h	5,5g
3 – High severity	24km/h	6,5g

Tab. 2: Test speed and acceleration FOLKSAM/SRA test series

pulse was changed in the 2nd test series from trapezoidal shape to triangular shape, but with the same test speed and mean acceleration. The test series should not be directly compared because of this change. However, the results should be very close to one another.

Other Test Specifications

- Dummy: BioRID (Denton, version E)
- Measurements: acceleration in head, chest, T1 and pelvis, forces and moments in upper and lower neck, belt load, head and chest velocity from film analysis.
- Head restraint in mid positions.
- Seat back angle: 25 degrees using an H-point dummy
- Seat belt: generic seat-belt (non-car specific but geometry close to car geometry)

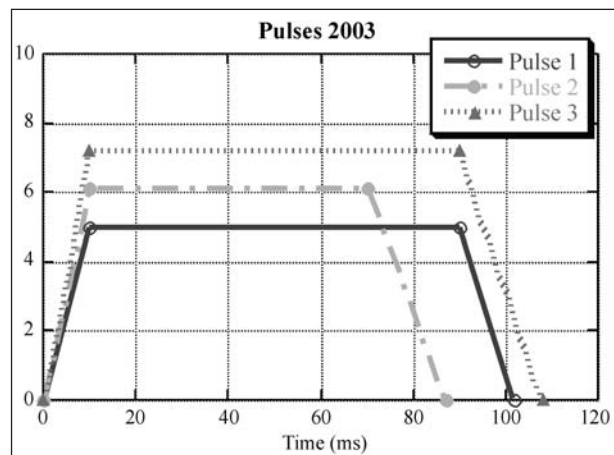

Fig. 1: Pulses used in the first test series (2003)

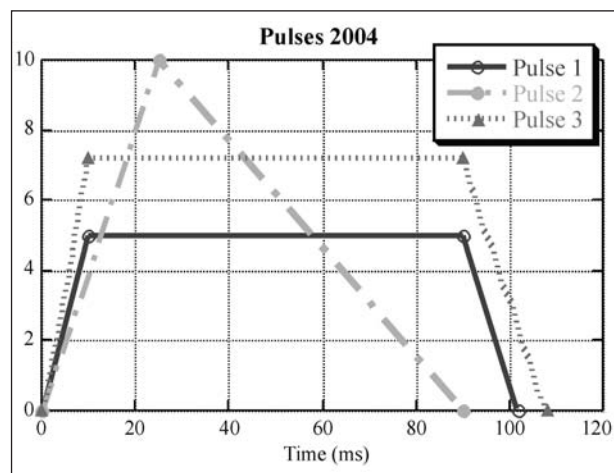

Fig. 2: Pulses used in the second test series (2004)

Measurements and Criteria FOLKSAM/SRA

To rate the various seats regarding risk of whiplash injury 3 parameters were measured and used, NIC_{max} , N_{km} and head rebound velocity. The overall rating is based on point scores. In the calculation of points, the seats got points if each measured parameter exceeded critical limits as described in table 3. Two limits per injury criteria were used and maximum 2 points for NIC_{max} and N_{km} were given, while maximum 1 point was given for head rebound velocity. High point scores indicate poor protection levels.

For each car model all points were summed for all three tests. To be regarded as a low risk seat maximum 5 point were allowed (labelled green). Between 5.1 and 10 points the seat was regarded as having average risk (labelled yellow), and above 10.1 points the seat model was regarded as having high risk (labelled red).

Results

All test results from 2004 and 2003 using the crash test pulses described in figure 1 and 2 and the limits of table 3 are published and available via the internet (www.folksam.se or www.vv.se). The tests were carried out at Autoliv using a Hyge-sled.

In average cars fitted with whiplash protection scored better results, see table 4, but there are also large differences within those seats with whiplash protection. Some of these seats did not get good ratings.

IIWPG/Thattham

The rating procedure used by the International Insurance Whiplash Prevention Group (IIWPG) and Thattham for evaluating and rating the ability of seats and head restraints to prevent neck injury in moderate and low-speed rear-end crashes is a two-stage process, starting with measurements of the static geometry of head restraints and followed by a dynamic evaluation of those seats in a simulated rear-end crash. Note: the final rating procedure is still under discussion.

Criterion	Lower limit	Upper limit	Green Low risk	Yellow Medium risk	Red High risk
NIC_{max}	$> 15m^2/s^2$	$> 18m^2/s^2$	$\leq 15 m^2/s^2$	$15 < NIC_{max} \leq 18$	> 18
N_{km}	$> 0,3$	$> 0,4$	$\leq 0,3$	$0,3 < N_{km} \leq 0,4$	$> 0,4$
Rebound velocity	$> 4.5m/s$	$> 6.0m/s$	$\leq 4.5 m/s$	$4.5 < Vel. \leq 6,0$	$> 6.$

Tab. 3: Critical limits and points

Measurement and Rating of Static Head Restraint Geometry – the Initial Evaluation

Static geometry evaluations are based on measurements of height and backset that are made with a dummy representing an average-size adult male (HRMD). To be rated at least marginal, the top of a restraint should be no lower than the center of gravity of the head (no more than 10cm below the top of the head) and no farther behind the head than 11cm. Otherwise, the head restraint geometric evaluation is poor. Higher head restraints provide protection for even taller occupants, and closer head restraints can reduce the time the head is unsupported in a rear crash. An acceptable geometric rating implies a head restraint no farther than 8cm below the top of the head and no farther than 9cm behind it. Good geometry implies a head restraint no farther than 6cm below the top of the head and no farther than 7cm behind it (see figure 3).

	NIC_{max}	N_{km}	Rebound velocity
Seats with whiplash protection	16.6	0.34	4.4
Seats without whiplash protection	21.5	0.43	4.6

Tab. 4: Average of measurements for cars with and without whiplash protection

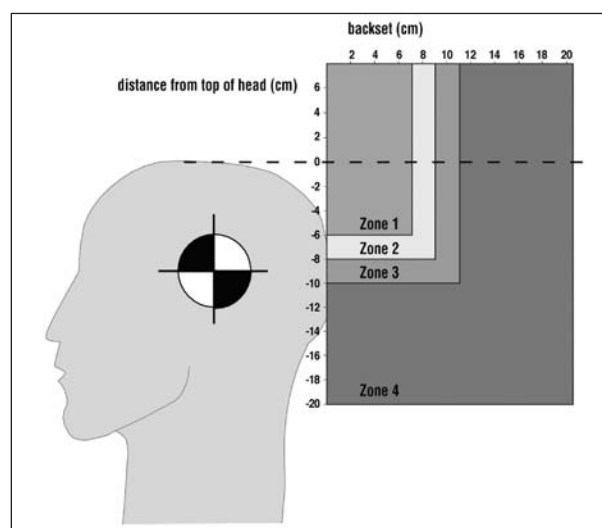

Fig. 3: Diagram of geometric head restraint rating

Seats with fixed geometry are rated using the measured height and backset when the seat is adjusted to a typical driving position. Seats with adjustable head restraints that cannot be locked into the adjusted position are rated based on measurements from the unadjusted (lowest and rearmost) position of the head restraint. Seats with locking head restraint adjustments are rated using the midpoint between the lowest/rearmost adjustment and the highest/foremost adjustment.

The rating procedure is detailed in the Research Council for Automobile Repairs (RCAR) publication, Procedure for Evaluating Motor Vehicle Head Restraints (2001). However, although this RCAR procedure assigns a good evaluation to all active head restraints, the IIWPG static evaluation will reflect the same measurement criteria as for nonactive head restraints. The additional benefits of active head restraints, if any, will be assessed through dynamic testing.

For head restraints with marginal or poor geometry, the geometric rating becomes the final rating. Head restraints with acceptable or good geometry undergo dynamic testing, as described below.

Dynamic Test Requirements

The dynamic test consists of a simulated rear crash on an acceleration sled using a BioRID IIe dummy positioned in the seat to be tested. The acceleration profile (delta V 16km/h) is roughly triangular, with a peak of 10g and a total duration of 92ms (figure 4). Seats with adjustable head restraints are tested with the restraints adjusted to match the position on which the seat's geometry is rated.

The specific details of the test procedure are described in IIWPG Protocol for the Dynamic

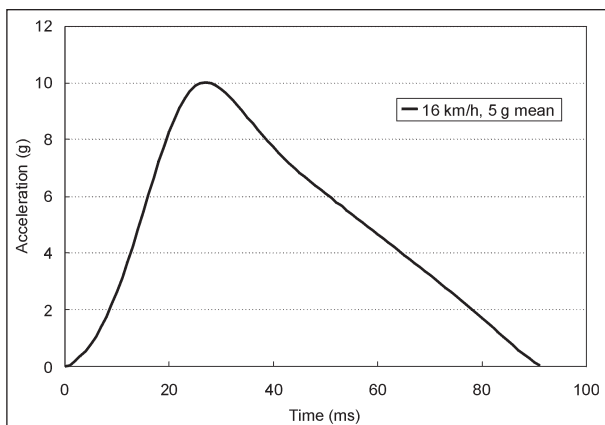

Fig. 4: IIWPG 16km/h test pulse

Testing of Motor Vehicle Seats for Neck Injury Prevention.

Dynamic Test Criteria

The dynamic test criteria are divided into two groups:

- seat design parameters and
- test dummy response parameters.

If one or both of the seat design parameters are below the specified thresholds, then the dummy response parameters are used to assure that the head and neck are supported without excessive stresses or neck distortion. To pass the dynamic test, all seats must meet criteria for neck forces (shear and tension) and neck distortion (retraction of the head relative to first thoracic vertebra, T1; this parameter may be discarded if research indicates that it fails to add useful information).

Seat Design Parameters

There are two seat design parameters:

- Time to head restraint contact must be less than 70ms (preliminary threshold) to pass this requirement. Time to head restraint contact is the time after the sled acceleration/deceleration reaches 1.0g that the dummy's head contacts the head restraint, as indicated by an electrical contact switch attached to either the dummy's head or the head restraint.
- Alternately, the maximum T1 forward acceleration must be less than 9g (preliminary threshold). This limit is based on the maximum T1 accelerations recorded in tests of Volvo Whiplash Injury Prevention System (WHIPS) seats, which include energy-absorbing/force-limiting seatback hinges. Maximum T1 forward acceleration is the highest acceleration recorded by an SAE J211-compliant (CFC 60Hz) and horizontally oriented accelerometer attached to BioRID's T1 vertebral unit anytime between the beginning of the test and the time the dummy's head first leaves contact with the head restraint at the beginning of the rebound phase of the simulated crash.

The first seat design parameter, time to head restraint contact, requires that the head restraint or seatback contact the seat occupant's head early in

the crash. The main purpose of requiring a head restraint to have only a small distance behind the head is to reduce the time until the head is supported by the restraint. Thus, the time-to-head-restraint-contact parameter assures that initially acceptable and good static geometry is not made irrelevant by poor seat design.

Some seats are designed to absorb some of the crash energy so that occupants experience lower forward accelerations. This aspect of performance is measured by the forward acceleration of the seat occupant's torso (T1 acceleration), which is the second seat design parameter. In some cases these designs may result in later head contact times.

Seats with features that reduce head restraint contact time or have effective energy-absorbing characteristics have been shown to provide better protection from neck injury in rear crashes than seats with reasonably similar geometry fitted to the same car models (FARMER et al., 2003). To pass the dynamic test, a seat must meet at least one of the thresholds for the seat design parameters, i.e., time-to-head-restraint-contact or the T1 acceleration.

The final rating of any seat design that fails to meet at least one of these criteria will be one category lower than its initial static geometry rating — that is, marginal or acceptable for seats with acceptable or good geometric ratings, respectively.

Test Dummy Response Parameters

There are two dynamic test requirements based on BioRID response parameters. These are maximum neck shear force and maximum neck tension.

To pass the dynamic test, a seat must meet both of the following requirements:

- The maximum neck shear force must be less than 130N (preliminary threshold), and
- the maximum neck tension force must be less than 600N (preliminary threshold)

during the time between the beginning of the test and when the dummy's head first leaves contact with the head restraint at the beginning of the rebound phase of the simulated crash. These limits represent performance achievable by a range of seat designs current in the 2003 model year when the test set-up represents good static geometry.

Any seat design that fails to meet either of these dummy force criteria will be rated one category lower than its initial geometric rating — that is, marginal or acceptable for seats with acceptable or good geometric ratings, respectively.

Results of a current test series with about 200 car seats are expected to be published in November 2004.

ADAC 2003

The ADAC test procedure is similar to IIWPG test procedure and also uses the BioRID II dummy.

ADAC is performing a second whiplash test (25km/h, max. 16g) and an additional seat stability test (30km/h, max. 17g, with a Hybrid III 95%-Dummy). For the fixation of the BioRID dummy a head and neck holder to fulfil the requirement to the pre-test position of the dummy (deceleration sled).

Assessment Criteria

To rate the various seats regarding risk of whiplash injury 5 parameters are measured and used, NIC, N_{km} , LNL, extension rotation and retraction.

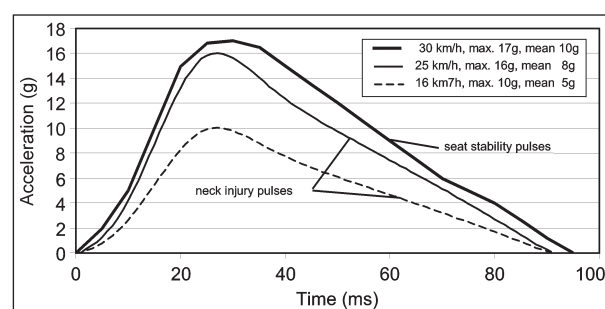

Fig. 5: Pulses for STNI and seat stability testing

Criteria	lower limit	upper limit
NIC	10	20
NKM	0,3	0,5
LNL	1,5	3
Extension Rotation	5	25
Retraction	10	15

Tab. 5: Seat assessment criteria

mark	classification	
0.6 ... 1.5	++	very good
1.6 ... 2.5	+	good
2.6 ... 3.5	O	sufficient
3.6 ... 4.5	T	marginal
4.6 ... 5.5	-	poor

Tab. 6: Final rating of ADAC

Effects such as failure of active head restraints, dummy ramping and fractures of the seat are monitored as well.

The lower limits apply to the best possible mark 0.6, the upper limits to the worst possible mark 5.5. Within these limits a sliding scale is used.

For the total rating the neck injury protection is weighted with 70%, and seat stability with 30%.

If one of the individual marks is $>4,5$ a penalty of 1 mark is applied.

ADAC published a test series with 10 B-class cars in November 2003 and will probably publish a new test series early 2005. The results of the 2003 test series are available under www.adac.de.

As soon as the EuroNCAP test and assessment protocol will be released ADAC will adopt the test procedure.

ACEA

ACEA has performed a study regarding whiplash testing. The purpose of the ACEA study was to examine the repeatability and reproducibility of some proposed test designs and seat assessment criteria.

The test program was conducted in two phases:

- phase 1 is addressing the repeatability and
- phase 2 the reproducibility issue.

In phase 1 three different seat models were used (Saab 9-3, Skoda Fabia, BMW 3). Three repeat tests of each seat have been performed using a Δv 16km/h pulse (IIWPG pulse). All repeat testing was conducted at Thatcham.

In phase 2 the same three different seat models were used. The testing was conducted in five different labs (using the same test protocol). One test per configuration was performed (Δv 16km/h (IIWPG) and 25km/h (ADAC)).

Results of the ACEA Study

Regarding the HRMD measurements and set-up procedure (cf. figures 6 and 7) a first sight analysis shows that reproducibility issues still exist. The repeatability of the HRMD measurement is acceptable.

However, the use of the set-up procedure by the different labs caused seat back angle (stem angle)



Fig. 6: HRMD (Head Restraint Measurement Device)

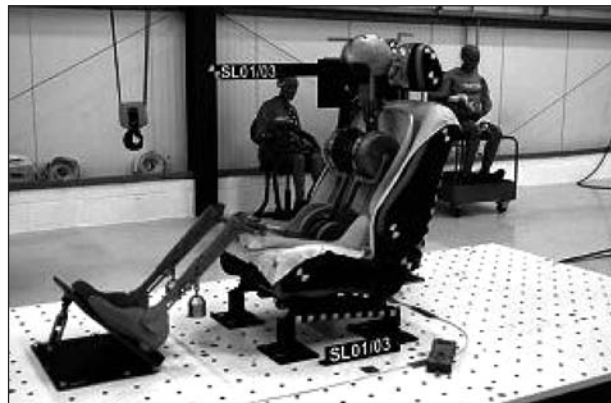

Fig. 7: HRMD (Head Restraint Measurement Device)

differences of up to 4deg. This could be seen as significant. One degree change in the stem angle will lead in theory to 15mm increase in backset.

In the practical measurement the maximum differences of backset and height for reproducibility were more than 20mm and would automatically lead to different ratings.

Regarding the sled and pulse parameters significant variation in pulse and set up have been documented. The repeatability of sled pulses appears to be acceptable. A corridor for the 25km/h needs to be defined (only seat stability). A general accepted definition of t_0 is needed. No clear influence of sled type (deceleration or acceleration sled) on the initial dummy (head) position was observed.

Analysis of Criteria for Reproducibility (16km/h)

Figure 8 and 9 show the maximum scattering for different seat assessment/rating criteria that were recorded during the test series. Figure 8 shows the results for the IIWPG pulse (16km/h) and figure 9

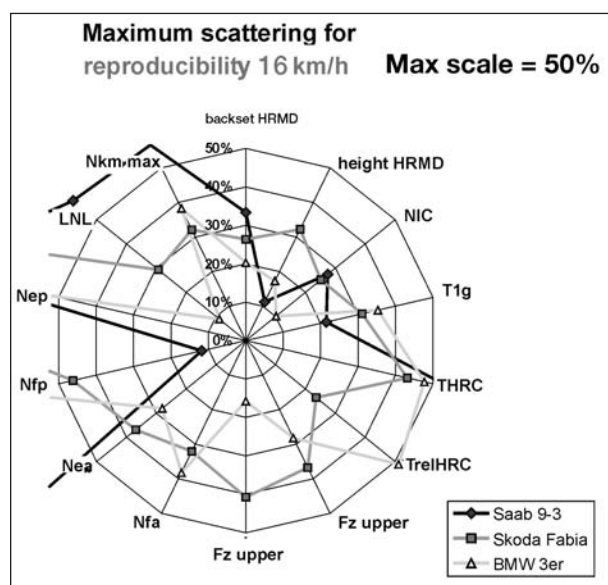

Fig. 8: Scattering for reproducibility (16km/h)

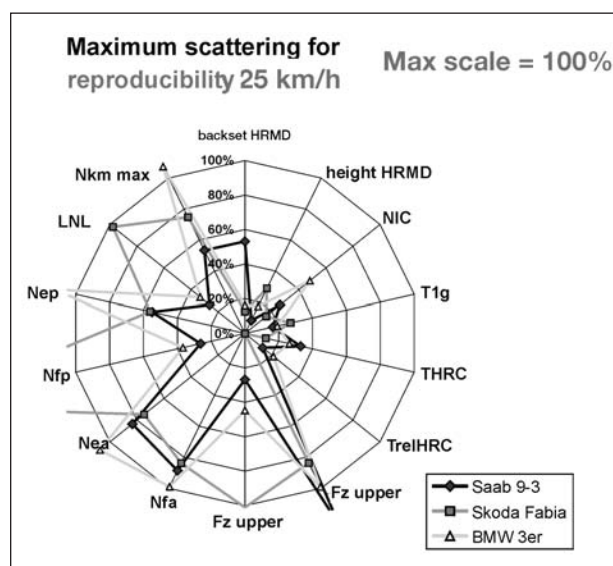

Fig. 9: Scattering for reproducibility (25km/h)

for the 25km/h ADAC pulse. Note that the max. scale in figure 9 (100%) is the double of the max. scale in figure 8 (50%).

The following conclusions on the rating criteria can be drawn:

- Repeatability (16km/h) is acceptable, with the exception of the Nep value (no influence on Nkm max for these tests).
- For the delta v 16km/h tests Nkm (all) and HRC show variations of more than 50%. Forces (Fx/Fz), LNL and T1 show a variation between 20-40%. NIC shows the lowest variation with values below 30%.

- Reproducibility is significantly degraded when delta v 25km/h pulse is used compared to delta v 16km/h.
- In particular the forces and force based criteria show extreme variations (>100%) with delta v 25km/h pulse.
- Result variations clearly question the suitability using these measures at the high severity pulse (delta v 25km/h).

EuroNCAP Whiplash Subgroup

The EuroNCAP whiplash subgroup has discussed various proposals for test procedures (IIWPG, ADAC, SRA, ACEA). The subgroup will make/has made decisions on the basis of these test results. Many parameters like pulse shape, assessment criteria, etc. have yet not been fully agreed by the members of the subgroup. There are still further data and discussion needed. EuroNCAP wants to have a co-operation with EEVC WG 20.

No final agreements have been reached so far but there is a strong tendency towards:

- Sled test based test procedure using a generic pulse
- More than one test and pulse/speed to avoid sub-optimisation
- 16km/h IIWPG as first choice, seat stability test and OOP under consideration
- No need for a 10km/h low speed test
- Using a BioRID dummy latest build level

The test programme will be based on the existing proposals from ADAC, Thatcham and SRA and the results of the ACEA study. Up to now there has been no decision about how to integrate whiplash testing in the EuroNCAP test program.

A first draft of a test and assessment protocol might be available in spring 2005. Testing might start at the end of 2005. The draft procedure has to be agreed by the EuroNCAP Technical Working Group and approved by the Assembly.

An integration of the whiplash rating into the overall vehicle score is probable.

EEVC WG 20

No regulatory test exists in Europe to assess injury risk in rear impacts, in particular at low severity. To

date the EEVC has not been able to develop a viewpoint on rear impact and WAD type injury. In the year 2000 the EEVC Steering Committee asked the EEVC WG 12 to create an ad-hoc working group to investigate the possibility of developing an EEVC view on rear impact and WAD injury. The ad-hoc group found that there was significant amount of research data available and that interesting and promising research projects were ongoing. It recommended the EEVC Steering Committee to start up a new activity with the aim of developing a proposal for a new European regulatory test for whiplash injury (AIS 1 neck injury) protection in rear-end collisions.

The EEVC Steering Committee initiated a new working group, WG 20, and it also gave the WG 12 additional terms of reference regarding the selection of an appropriate crash dummy for the rear impact test procedure.

The terms of reference of the EEVC WG 20 rear impact test procedure(s) and the mitigation of neck injury are as follows:

- Develop test procedure(s) for rear-end collisions, with a prime focus on neck injury reduction (whiplash).
- Draft proposal(s) and report to the Steering Committee within one year of the first meeting.
- Evaluate the proposed test procedure(s) in laboratory conditions and, if needed, make appropriate adjustments to the procedure(s).
- Write final test procedure proposal(s) and report to the Steering Committee within two years of the group's first meeting.

Explanatory comments 1 on the terms of reference:

- The test procedure(s) should include a dynamic sled-based test using generic crash pulses, unless it can be shown to be inappropriate.
- Test conditions should be appropriate with regard to real world accident data.
- Appropriate injury criteria, to be measured in the dummy, will be selected in association with EEVC WG 12.
- In order to ensure that one injury risk (neck) is not reduced with an increase in other injuries (e.g. spine, or soft tissue), due regard should be

given to a holistic approach to rear impact injury risk reduction.

The test procedure(s) must address the range of vehicle properties that can influence occupant loading as a function of the vehicle crash pulse, e.g. use of the seat-belt system and the seat system with vehicle body attachment points.

Explanatory comments 2:

- The procedure must include consideration of active safety systems that are triggered by crash sensor information, pre-crash sensor information or occupant interaction(s) and position.
- The test procedure(s) assessment parameters must correlate to injury risk.
- A close relationship should be established with EEVC WG 12, the Biomechanics group, regarding the selection of the most appropriate dummy, injury criteria and injury risk probability relationships. WG 20 will be responsible for co-ordination with WG 12.
- WG 20/WG 12 will select the most appropriate size of dummy for the test procedure(s).
- WG 20 will supply WG 12 with all the necessary input data regarding crash conditions, instrumentation and requirements and the interface between dummy and test set-up.
- Any procedure(s) must have regard to other impact conditions and impacts severities, to avoid sub-optimisation of safety system design, as well as existing standards and regulations.

Current Status of EEVC WG 20 Work

EEVC WG 20 has written a first draft proposal of a dynamic test procedure, based on the IIWPG test procedure. The actual injury, causing the typical WAD symptoms, is however still unknown (though several hypotheses exist), and the injury mechanism has thus not been established. The evaluation of the currently proposed injury criteria (LNL, Nkm, T1-rebound velocity, NIC, NDC, IV-NIC, etc.) and the calculations of the associated risk curves are however not founded in biomechanical research but instead statistically derived from field accident data and reconstructions of real world accident situations. WG 20 had long discussions

about the acceptability of an injury criterion that is not based on the biomechanical relationship between loading to the body and injury causation ("black box"). The term "black box approach" denotes the definition of an injury criterion that is based on indirect statistically based evidence. WG 20 has asked the EEVC Steering Committee for guidance on this approach. Provided that the EEVC Steering Committee will approve the validation of injury criteria based on statistical analysis of field accident findings, the WG 20 appears to have a reasonable chance of establishing a test procedure proposal in accordance with its terms of reference.

WG 20 has received new indications that may delay the selection of an injury criterion (or injury assessment value). Earlier indications of good correlation to field accident data of Nkm and NIC appear to be contradicted by recent findings within the EU-Whiplash2 project and indicate better correlation to injury risk with LNL. Therefore further work to investigate the statistical methods behind these studies is needed and this adds some uncertainty about the time frame of the WG 20.

WG 20 has drafted a geometric test procedure and believes that it could be a valuable interim upgrade of the current regulation. If the EEVC Steering Committee approves, the WG 20 is prepared to continue working on the document and present a final draft, Autumn 2004.

Conclusions

The SRA/FOLKSAM test procedure is well established in Sweden. SRA/FOLKSAM will continue testing until EuroNCAP has finalised its test procedure

The ADAC test procedure contains a seat stability test and a high (too) severe whiplash test. ADAC also will adopt the Eur NCAP test procedure.

IIWPG/Thatcham is based on a static assessment (geometry). Dynamic testing (1 pulse) is only carried out with seats with "good" or "acceptable" geometry. IIWPG will continue with their test and assessment protocol (all vehicle models and US activities).

The ACEA test series shows that reproducibility is an issue of major concern. Especially the 25km/h pulse (mean acceleration 8g as used by ADAC) is not suitable for whiplash assessment.

EuroNCAP might present a draft of the test and assessment procedure in spring of 2005.

EEVC WG 20 is working on a static and dynamic test procedure. Further work is depending on the decision of the EEVC Steering Committee.

References

- [1] HELL, W.; LANGWIEDER, K.; WALZ, F.: Occurrence of reported cervical spine injuries in car accidents and improved safety standards for rear-end impacts. WAD-Conference, Vancouver, 1999
- [2] MORRIS, A. P.; THOMAS, P.: A study of soft tissue neck injuries in the UK. Proc. 15th ESV Conf., Paper No. 96-S9-O-08, 1996
- [3] FOLKSAM: "How safe is your car? 2001". FOLKSAM research 10660 Stockholm, Sweden, 2001
- [4] KRAFFT, M.: Non fatal injuries to car occupants. PhD thesis, FOLKSAM research 10660 Stockholm Sweden, 1998
- [5] SPITZER, W.; SKOVRON, M. L.; SALMI, R.; CASSIDY, D.; DURANCEAU, J.; SUISSA, S.; ZEISS, E.: Scientific monograph of the Quebec task force on whiplash associated disorders: Redefining "whiplash" and its management. Spine, Vol. 20, No. 8S, 1995, pp 9-11, 27, 28, 30
- [6] SCHMITT, K.-U.; MUSER, M.; VETTER, D.; WALZ, F.: Biomechanical assessment of soft tissue neck injuries in cases with long sick leave times. Proc. IRCOBI conference, Munich (Germany), September 18-20, 2002
- [7] HELL, W.; LANGWIEDER, K.; WALZ, F.: Reported soft tissue neck injuries after rear-end car collisions. Proc. IRCOBI conference, Gothenburg, 1998
- [8] MURRAY, P. A.; PITCHER, M.; GALASKO, S. C. B.: The cost of long-term disability from road traffic accidents, four year study – final report. TRL Project Report 45, 1993
- [9] TEMMING, J.; ZOBEL, R.: Frequency and risk of cervical spine distortion injuries in passenger car accidents. Significance of human factors data. Proc. IRCOBI conference, Gothenburg, 1998

- [10] MAAG, U.; LABERGE-NADEAU, C.; XIANG-TONG, T.: Neck sprain in car crashes: Incidence, associations, length of compensation and cost to the insurer. Proc. of the 37th AAAM conf., San Antonio, 1993
- [11] YDENIUS, A.; KULLGREN, A.: Injury risk functions in frontal impacts using recorded crash pulses. Proc. IRCOBI conference, Isle of Man, 2001
- [12] BERGLUND, A.: On associations between different factors and whiplash injury. PhD thesis, Karolinska Institute, Stockholm, Sweden, 2002
- [13] KRAFFT, M.; KULLGREN, A.; LIE, A.; TINGVALL, C.: The risk of whiplash injury in the rear seat compared to the front seat in rear impact. Proc. IRCOBI conference, Munich (Germany), September 18-20, 2002
- [14] VIANO, D.: Seat influences on female neck responses in rear crashes: a reason why woman have higher whiplash rates. Journal Traffic Injury Prevention, 4, 228-239, 2003
- [15] HELL, W.; LANGWIEDER, K.: Consequences for seat design due to rear end accident analysis, sled tests and possible test criteria for reducing cervical spine injuries after rear-end collision. Proc. IRCOBI conference, Sitges, September 1999
- [16] PARKIN, S.; MACKAY, M.; HASSAN, A. M.; GRAHAM, R.: Rear-end collisions and seat performance – To yield or not to yield. Proc. of the 39th AAAM conf., Chicago, pp 231-244, 1995
- [17] FORET-BRUNO, J. Y.; DAUVILLIERS, F.; TARRIERE, C.; MACK, P.: Influence of the seat and head rest stiffness on the risk of cervical injuries in rear impacts. Proc. of the 13th ESV conf., Paris, pp 968-974, 1991
- [18] EICHBERGER, A.; GEIGL, B.; MOSER, A.; FACHBACH, B.; STEFFAN, H.; HELL, W.; LANGWIEDER, K.: Comparison of different car seats regarding head-neck kinematics of volunteers during rear-end impact. Proc. IRCOBI conference, Dublin, 1996
- [19] RYAN, G. A.; TAYLOR, G. W.; MOORE, V. M. et al.: Neck strain in car occupants: the influence of car related factors on initial severity. Medical Journal of Australia, Vol. 159, pp 651-656, 1993
- [20] OLSSON, I.; BUNKETORP, O.; CARLSSON, G.; GUSTAVSSON, G.; PLANATH, I.; NORIN, H.; YSANDER, L.: An in-depth study of neck injuries in rear-end collisions. Proc. IRCOBI Conf., 1990
- [21] KRAFFT, M.; KULLGREN, A.; YDENIUS, A.; TINGVALL, C.: Influence of crash pulse characteristics on whiplash associated disorders in rear impacts-crash recording in real-life crashes. IIWPG whiplash symposium at the IRCOBI Conf., Isle of Man, October 2001
- [22] KRAFFT, M.; KULLGREN, A.; YDENIUS, A.; TINGVALL, C.: Influence of crash pulse characteristics on whiplash associated disorders in rear impacts-crash recording in real-life crashes. Crash Prevention and Injury Control, 2002
- [23] KULLGREN, A.; ERIKSSON, L.; BOSTRÖM, O.; KRAFFT, M.: Validation of neck injury criteria using reconstructed real-life rear-end crashes with recorded crash pulses. Proc. of the 2003 ESV conference, paper 344, Nagoya, Japan, 2003
- [24] McCONNELL, W. E.; HOWARD, R. P.; POPPEL, J., et al.: Human head neck kinematics after low velocity rear-end impacts – understanding “whiplash”. Proc. 39th Stapp Car Crash Conf., November, Coronado, USA, 1995
- [25] ONO, K.; KANEOKA, K.: Motion analysis of human cervical vertebrae during low speed rear impacts by simulated sled. Proc. IRCOBI conference, Hannover, 1997
- [26] SIEGMUND, G. P.; KING, D. J.; LAWRENCE, J. M.; WHELLER, J. B.; BRAULT, J. R.; SMITH, T. A.: Head/neck kinematic response of human subjects in low speed rear-end collisions. Proc. 41st Stapp Car Crash Conf., Lake Buena Vista, USA, 1997

K. Okamura, S. Ito
Institute for Traffic Accident Research and Data
Analysis, Tokyo, Japan

Pedestrian Road Accidents in Japan

Abstract

This report gives an overview of pedestrian accidents on Japanese roads. Database used for the analysis is national traffic accident data based on police reports. Relevant measures and background information ranging from vehicle safety, engineering and education are briefly reviewed, and area for further improvement is discussed.

Background

In 2003, 2,332 pedestrians were killed (within 24 hours) and 85,592 were injured on Japanese roads. Pedestrian deaths represent 30% of all traffic accident deaths, the second largest category next to 4-wheeled motor vehicle occupants. For the last ten years, pedestrian deaths have been declining, but pedestrian injuries have been increasing by about 7% during the same period.

Road accident is the biggest cause of accidental deaths among children. Injury while walking is therefore also the biggest concern for child health, but it is not necessarily perceived as such. Pedestrian death, on the other hand, is often considered to be a specific problem of older people, due to the fact that 64% of fatally injured pedestrian are 65 years of age and over. It seems

generally to be agreed that children and older people are the main safety target given their limited choice of transport mode other than walking due to low driving licence holding rate, immature traffic skills or physical frailty in old age. However, injury to adult pedestrians is equally important: adults account for the largest proportion of pedestrian injuries and vehicle safety measures are often based on scientific data assuming mostly adult pedestrian accidents.

Purpose and Method

This report aims to describe overall characteristics of pedestrian road accidents in Japan, by presenting tabulations and diagrams of selected variables from traffic accident data from 2001 to 2003. Relevant measures are briefly reviewed and area for further improvement is discussed.

National traffic accident database based on police reports is used. This database, owned by Institute for Traffic Accident Research and Data Analysis (ITARDA), has an extra set of variables linked to this. This includes vehicular details, which this report utilises. The database contains all accidents resulting in death or injury on public roads, including non-motor vehicle accidents, namely bicycle-pedestrian accidents, but do not contain pedestrian-only accidents.

Results from Accident Data

Accident Involvement and Fatality Rate by Sex and Age

As pedestrian exposure data are unavailable, relative accident risk of pedestrian is often expressed as population-based figures. As shown in table 1, risk

		Age group 6 & under	7-12	13-19	20-29	30-39	40-49	50-59	60-64	65-69	70-79	80+
Fatally injured	Male	0.93	0.49	0.25	0.58	0.67	1.07	2.08	2.98	3.73	4.92	10.96
	Female	0.28	0.43	0.09	0.20	0.13	0.29	0.83	1.59	2.67	6.10	10.56
Injured	Male	129.51	183.38	42.82	55.50	52.70	50.13	56.89	92.36	66.76	67.40	74.24
	Female	66.01	105.46	49.65	49.08	38.81	36.68	52.26	69.92	88.01	110.03	99.43

Tab. 1: Fatally injured or injured pedestrians per 100,000 population by sex and age group in 2003

		Age group 6 & under	7-12	13-19	20-29	30-39	40-49	50-59	60-64	65-69	70-79	80+
Male		0.71	0.26	0.57	1.03	1.25	2.09	3.53	4.56	5.29	6.80	12.86
Female		0.42	0.40	0.17	0.42	0.34	0.79	1.55	2.22	2.95	5.25	9.60

A fatality rate denotes fatality injured divided by fatality or non-fatality injured

Tab. 2: Fatality rate in percentage by sex and age group in 2003

of death for pedestrian per 100,000 population is markedly high for older men and women, whilst injury risk is particularly high for boys, followed by older women and girls. Fatality rates shown in table 2 indicate that once involved in an accident older people are much more likely to die compared with younger people and that also the fatality rate is lowest for children/teenagers and rises sharply with increasing age.

Road Traffic Environment

Type of Road and Level of Injury

Eighty-two percent of pedestrian accidents occur in built-up area, 58% in densely inhabited area. Type of road may be a usable variable to express road use of casualties in relation to vehicle speed. Of this variable, 'national/prefecture (N/P) roads' and 'municipal roads' cover about 90% of where pedestrian accidents occurred. N/P roads include most arterials except for motorway and tend to be wider, sometimes multiple-lane, whereas municipal

roads tend to be narrower and include many residential streets with lower speed limits of 20-40km/h. Classification based on type of road does not always coincide with these features. Nevertheless, it can be used for describing characteristics of places pedestrians may be moving about and consequences of accident. Table 3 shows the distribution of pedestrian casualties by age group¹ and type of road, plus fatality rate. Among killed/injured pedestrians, children are over-represented in accidents on municipal roads compared with adults and older people. Older pedestrians are slightly over-represented in N/P road accidents compared with adults. Fatality rate is 2.5 to 4 times higher on N/P roads than on municipal roads. Fatality rate of older pedestrians on N/P roads is strikingly high with 11%.

Type of Road and Estimated Vehicle Speed

Estimated vehicle speed just before crash is investigated by the police and incorporated into the national database. This variable denotes travelling speed just before the driver recognises the hazard, and is often based on testimony. Despite arguments about its preciseness, it is

	Killed or injured			Fatality rate (%)		
	12 & under	18-49	65 & over	12 & under	18-49	65 & over
N/P road	13,408	25,894	27,640	1.0	2.0	11.0
Municipal road	40,184	41,261	33,247	0.4	0.5	3.9
Ratio of municipal to N/P	3.0	1.6	1.2			

N/P road means national or prefecture roads

Tab. 3: Pedestrian casualties and fatality rate by type of road 2001-2003

¹ Children 12 years old and under include all pre-school and primary school pupils in Japan. After this age group, travel mode changes as well as accident involvement as pedestrian. Age group of 18-49 is to represent relatively younger adults.

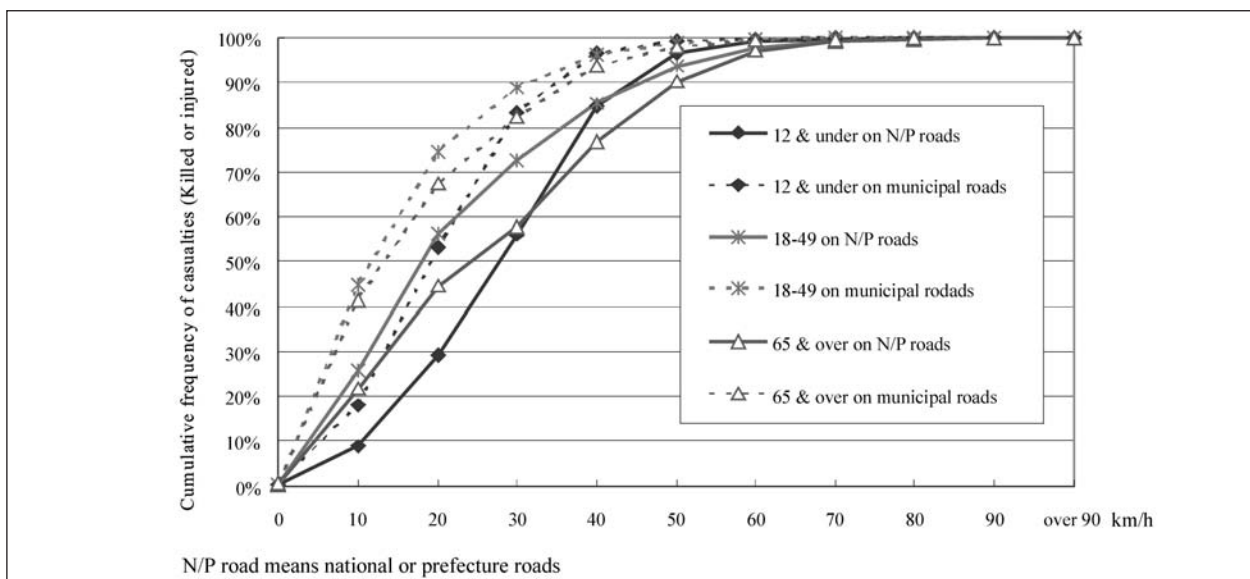

Fig. 1: Estimated vehicle speed just before crash when pedestrians were killed or injured by age group and type of road 2001-2003

useful to compare overall speed distribution. figure 1 shows estimated vehicle speed by type of road where pedestrians were killed or injured. For all three age groups, vehicles tended to travel slower on municipal roads compared with N/P roads. Adults were involved in accidents at slightly lower speed compared with older people on both N/P and municipal roads, whilst children were involved in accidents at higher speed than adults or older people (with the exception of 30km/h and above). At 50th-tile level, children were involved in accident at about 8km/h faster speed on municipal roads, and about 10km/h faster on N/P roads compared with adults.

Vehicle speed just before crash was lower in accidents which occurred on municipal roads than on N/P roads. Lower fatality rate of child pedestrians may be relevant with children's over-representation in municipal road accidents. Adults tended to be involved in accidents at lower speed compared with older people below 30km/h. This probably is explained by a lower fatality rate of adults than that of older people. Older people's over-representation in N/P road accident and faster vehicle speed may contribute to elevated fatality rates among this age group.

Crossing Accident or not

About 60% of pedestrian accidents occur while pedestrians are crossing the road. Table 4 details crossing and no crossing accidents by age group.

For all age groups, 'intersection accidents' and 'no intersection accidents' account for 50% and 43% respectively. Of 'intersection accidents', 78% were crossing accidents. Of 'no intersection accidents', just 45% were crossing accidents. Of 'crossing accidents at/near intersections', about 70% occurred at crossings, and about 70% of them occurred at light-controlled intersections. Of 'crossing accidents not at intersection', 86% occurred where there were no pedestrian crossings.

There is a marked difference between age groups. Children were over-represented in crossing accidents outside pedestrian crossings and intersection (29.3% of this age group), whereas a higher percentage of adult pedestrians was involved in 'no crossing accidents' not at intersections (28.1%). Older pedestrians were more likely to be involved in crossing accidents outside crossings compared with adults (14.1% at/near intersection, 15.9% not at intersection). Both adults and older pedestrian accidents are similar in that higher percentages of them were involved in accidents while crossing within crossings at/near light-controlled intersections, representing 23.3% and 20.7% of each group.

			All ages (n = 254,058)	12 & under (n = 56,513)	18-49 (n = 74,547)	65 over (n = 65,801)
At/near intersection	Crossing within crossing	Light-controlled	19.4	10.2	23.3	20.7
		No traffic light	7.7	8.9	6.1	8.5
	Crossing outside crossing	Light-controlled	1.4	1.1	1.4	1.6
		No traffic light	10.7	13.8	7.6	12.5
	No crossing accident	Light-controlled	2.5	1.1	3.5	2.1
		No traffic light	8.4	8.6	9.2	7.7
No intersection	Crossing within crossing	Light-controlled	0.4	0.5	0.3	0.4
		No traffic light	2.4	3.9	1.5	2.5
	Crossing outside crossing	Light-controlled	0.1	0.1	0.1	0.1
		No traffic light	16.6	29.3	10.2	15.8
	No crossing accident	Light-controlled	0.1	0.1	0.2	0.1
		No traffic light	8.4	8.6	9.2	7.7
Other (railway level crossing/parking etc.)			6.5	4.4	8.3	6.3
Column percent.						
Near intersection means within 30 metres from intersection.						
Rows surrounded by broken line are crossing accidents.						

Tab. 4: Accident classification in percentage by pedestrian age group, 2001-2003

Vehicle-Pedestrian Behaviour Prior to Accident

Manoeuvre of Vehicle

Sixty-five percent of vehicles that hit pedestrians were passenger cars, followed by goods vehicles (19%), two-wheeled motor vehicles (9%) and bicycle (2%). Table 5 outlines manoeuvre of vehicle that hit pedestrians. About 90% of two-wheeled motor vehicle were going straight when they hit pedestrian irrespective of pedestrian age group. When focused on passenger car and goods vehicle, most child pedestrians were hit when the vehicles was going straight, whereas lower percentages – just 43-50% of adult/older pedestrians were hit by a vehicle going straight. In adult/older pedestrian accidents, right-turning or reversing manoeuvre is distinctively more frequent. The higher percentage of vehicle going straight in child pedestrian accidents is well explained by their typical crossing accidents where there is no intersection. The higher percentage of right-turning vehicle in adult/older pedestrians is well in line with the higher incidence of crossing accidents at/near intersections.

Violation of the Law

As already described, the typical pattern of child pedestrian accidents is, “children are crossing outside intersection and crossing, and are hit by a vehicle going straight” (pattern I). Accidents of adults and older pedestrians are a little more varied, but if focused on crossing accidents, can be represented by two scenarios: pedestrians are crossing at/near intersection and hit by a vehicle going straight (pattern II), and pedestrians are crossing at/near intersection and hit by a right-turning vehicle (pattern III).

Police data have a variable ‘violation of the law’ for each party, as what they identified to be the major

violation leading to accident causation. figure 2 shows the combination of major violations by both driver and child pedestrian in accident pattern I. Figure 3 shows major violations by both adults and older pedestrians and vehicle that hit them in accident pattern II. Figure 4 shows pattern III of both adults and older pedestrian accidents.

Figure 2 indicates that a significant number of children darted out, and drivers failed to carry out ‘general duties of safe driving’ (such as applying appropriate speed, to be alert to possible hazard and making proper judgement). Figure 3a shows that frequent violations by adult pedestrians are red-light running, improper crossing, or crossing while being masked by vehicle. Violations by drivers who hit adult pedestrians are mostly related to ‘general safe driving duties’. Figure 3b shows that there were fewer red-light running by older pedestrian, whilst there were more ‘not giving way to pedestrian’ or ‘red-light running’ violations by drivers. Figure 4a and figure 4b show very similar patterns: very few pedestrians were found to have violations, but many drivers did not give way to pedestrians or failed to carry out general safe driving duties when turning right at intersection.

These results are summarised as follows. In crossing accidents of children that occurred outside intersections, children darted out and drivers did not fulfil general duties necessary to avoid an accident. In at/near intersections crossing accidents with the vehicle going straight, red-light running and improper crossing were typically found in adult/older pedestrians, but fewer older pedestrians ignored the light. Drivers failed to either carry out general safe driving duties or give way to pedestrians. In intersection crossing accidents with right-turning vehicle, most pedestrians did not violate the laws but ended up in an accident because drivers did not give way to pedestrians or failed to carry out general safe

	12 & under			18-49			65 & over		
	Passenger car (n = 37.551)	Goods vehicle (n = 11.230)	Two-wheeled motor vehicle (n = 4.337)	Passenger car (n = 47.654)	Goods vehicle (n = 11.862)	Two-wheeled motor vehicle (n = 7.047)	Passenger car (n = 40.562)	Goods vehicle (n = 14.003)	Two-wheeled motor vehicle (n = 6.103)
Starting	3.9	3.7	1.6	11.4	10.5	3.8	7.2	8.3	2.8
Going straight	86.6	86.0	94.9	44.9	44.6	88.8	49.2	42.7	93.1
Turning left	2.6	3.7	1.9	6.8	7.4	3.4	4.5	5.9	1.9
Turning right	4.0	4.5	1.6	25.9	26.5	3.9	24.0	30.3	2.0
Reversing	2.9	2.0	0.0	11.0	11.0	0.1	15.0	12.9	0.1

In Japan, traffic keeps to the left and most vehicles are right-hand driven.

Tab. 5: Vehicle manoeuvres that hit pedestrians by pedestrian age group and type of vehicle, 2001-2003

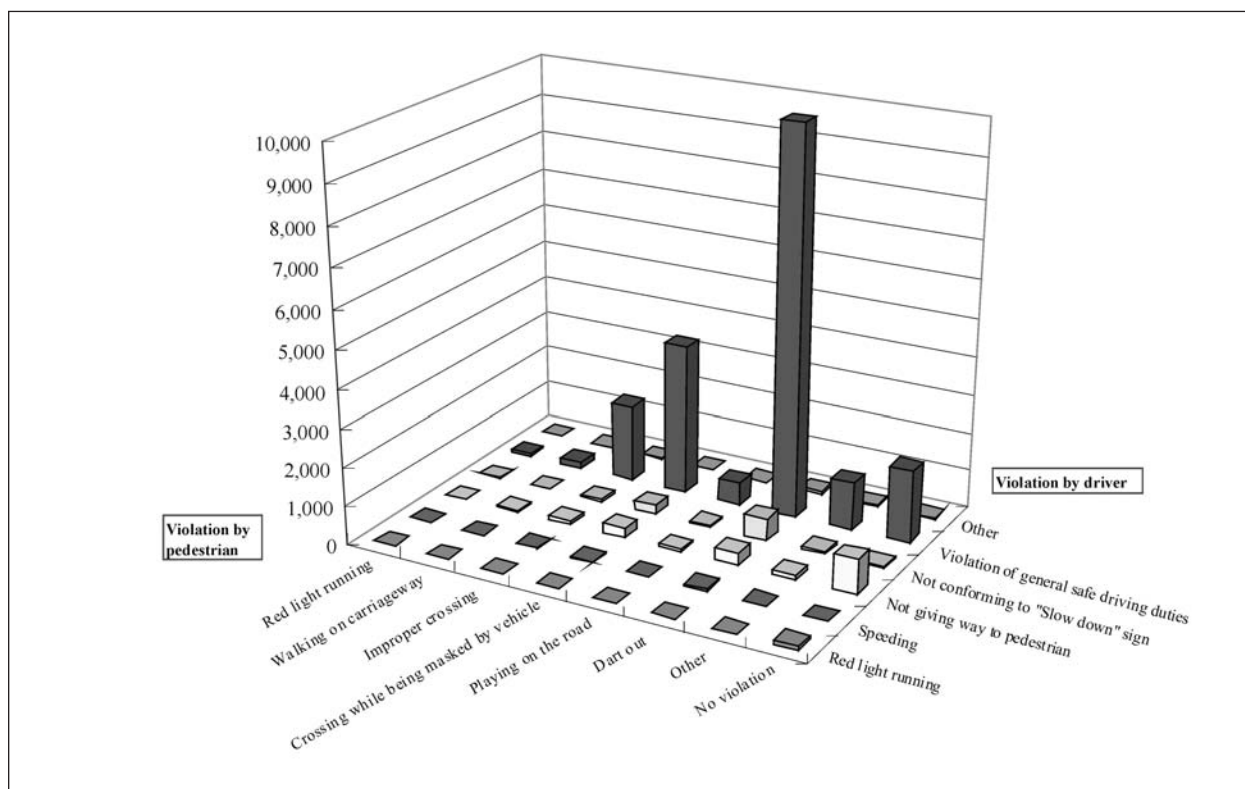

Fig. 2: Combination of major violations by child pedestrians and drivers going straight not at intersection: accident pattern I. 2001-2003
Violation by driver fewer than 100 and by pedestrian fewer than 10 are omitted for the sake of clarity.

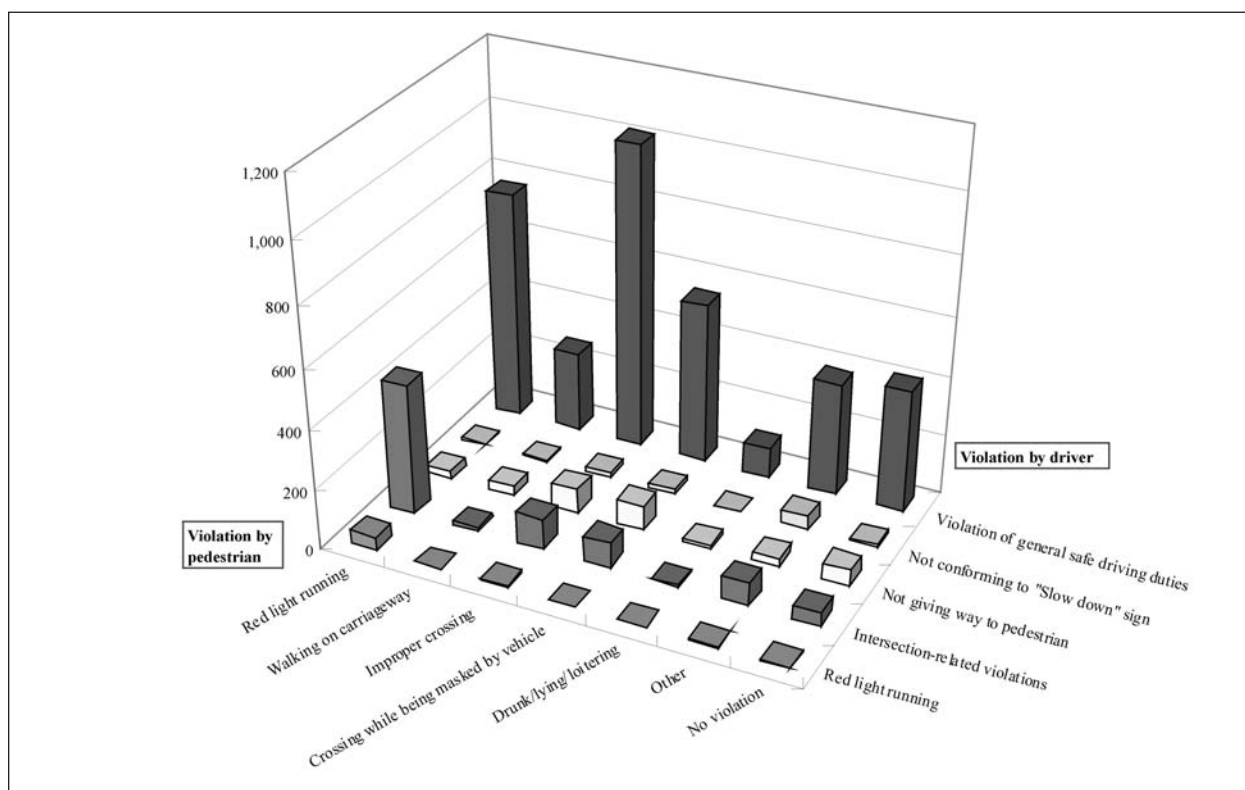

Fig. 3a: Combination of major violations by adult pedestrians (18-49 years old) and drivers going straight at/near intersection: accident pattern II. 2001-2003
Violation by driver fewer than 100 and by pedestrian fewer than 10 are omitted for the sake of clarity.

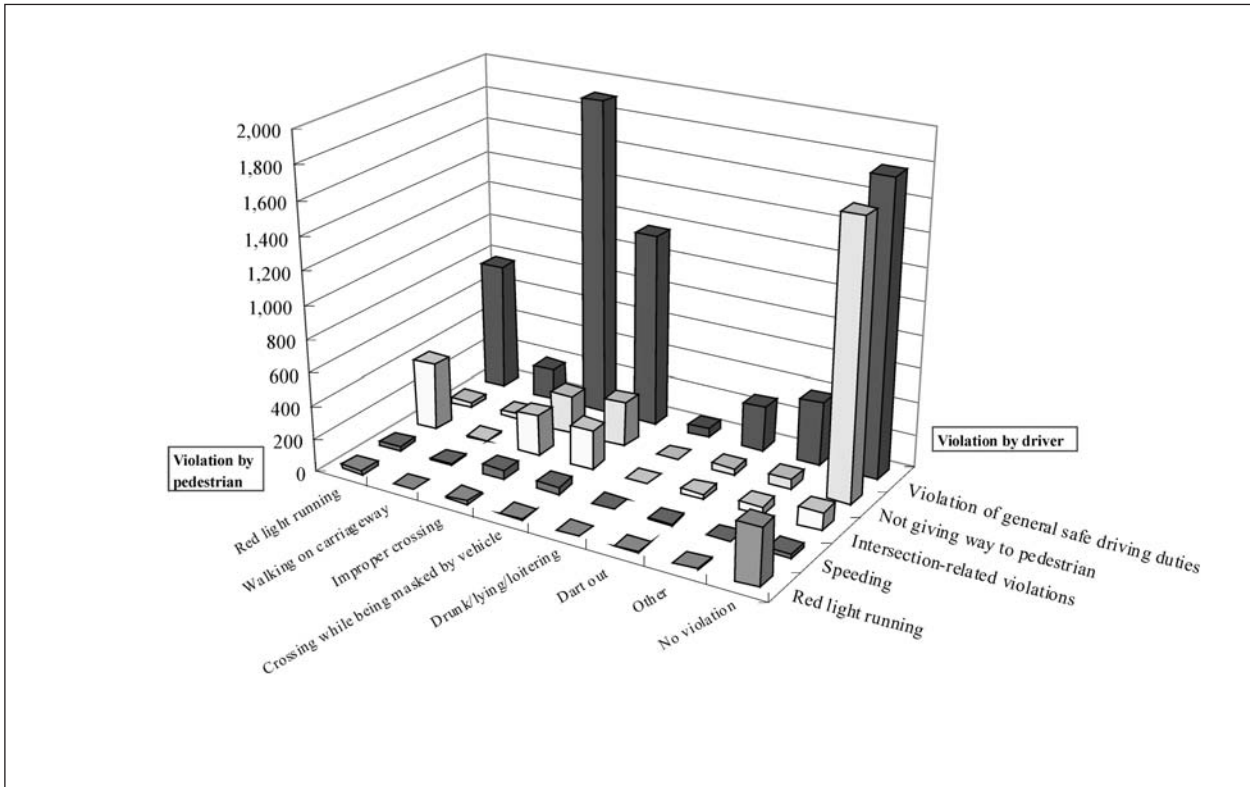

Fig. 3b: Combination of major violations by older pedestrians of 65 and over and drivers going straight at/near intersection: accident pattern II. 2001-2003
Violation by driver fewer than 100 and by pedestrian fewer than 10 are omitted for the sake of clarity.

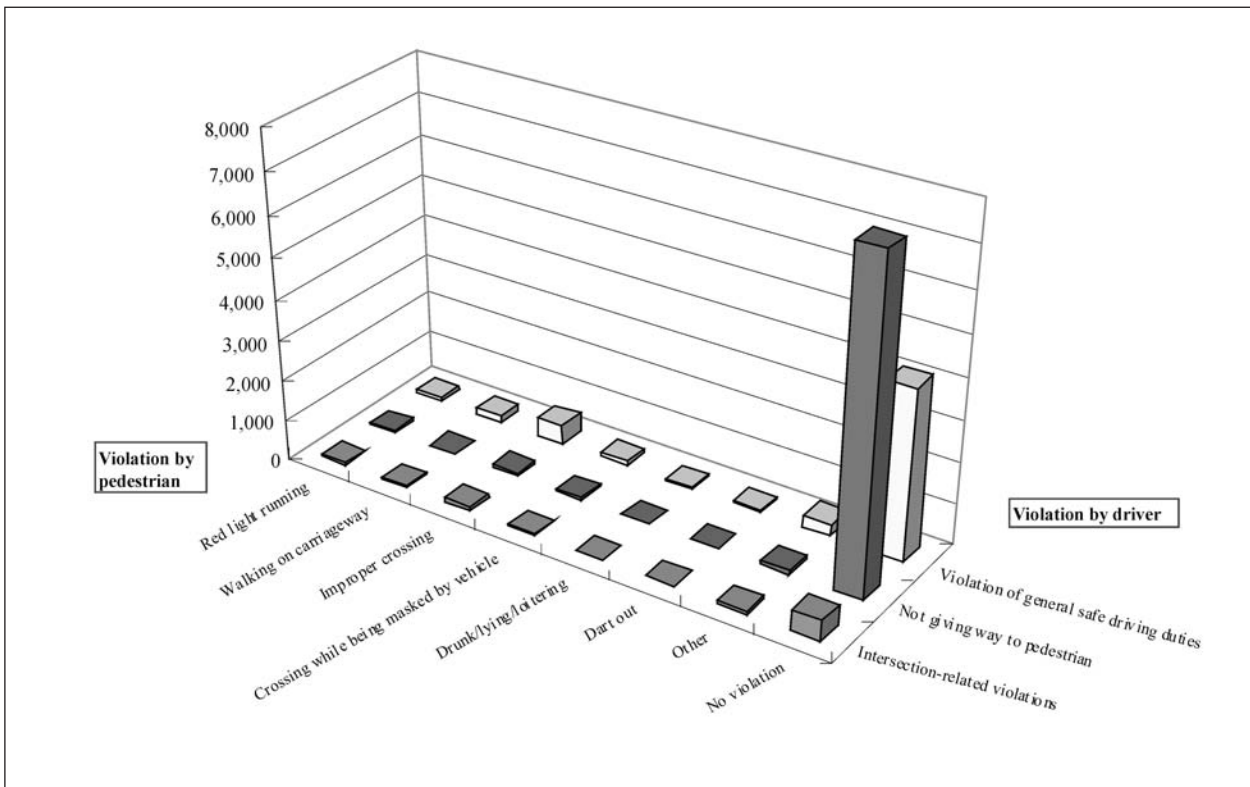

Fig. 4a: Combination of major violations by adult pedestrians (18-19 years old) and drivers turning right at/near intersection: accident pattern III. 2001-2003
Violation by driver fewer than 100 and by pedestrian fewer than 10 are omitted for the sake of clarity.

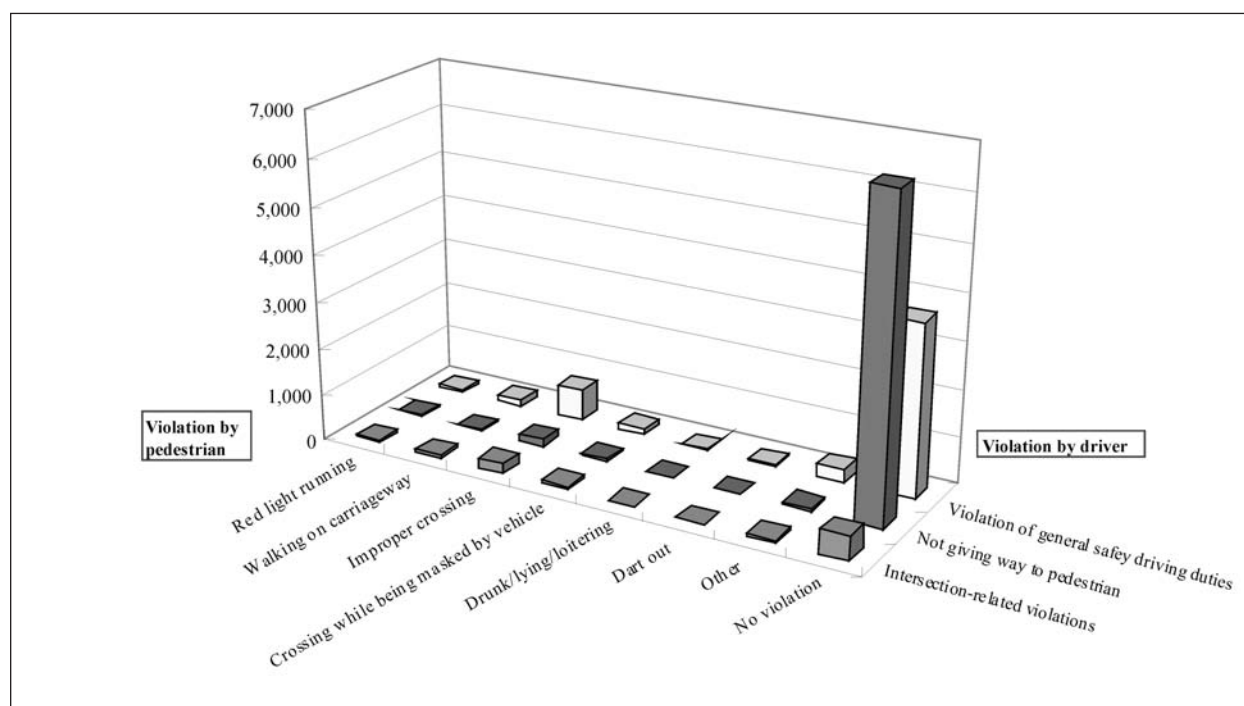

Fig. 4b: Combination of major violations by older pedestrians and drivers turning right at/near intersection: accident pattern III, 2001-2003

Violation by driver fewer than 100 and by pedestrian fewer than 10 are omitted for the sake of clarity.

driving duties. Interestingly, red-light running did not emerge as one of the most frequent violations in collision of right-turning vehicle vs. pedestrian. Both parties were proceeding according to the green light, and drivers failed to be ready to give way or to stop for pedestrians walking at crossing.

Relative Culpability

In each accident the police decide which party assumes more responsibility than the other in causing accident. The party judged to be more culpable is recoded as 'the most responsible party'. When it is not possible to weight the culpability of the two parties, one who sustains less serious injury is recorded as 'the most responsible party'. Table 6 shows the proportion of pedestrians judged to be most responsible by age group and level of injury. Pedestrians were generally less likely to be judged more culpable than the other party, but there are substantial differences between age group and injury level. Children were more likely to be judged culpable than adults or older people, except when they were fatally injured. Conversely, adults and older pedestrians were more likely to be judged culpable when they were killed than when they were injured. High culpability of injured children is probably related to a higher incidence of darting-out accidents where it is difficult for drivers

	12 & under	18-49	65 & older
Fatally injured	6.1	17.6	9.7
Seriously injured	12.3	7.2	4.2
Slightly injured	11.5	3.5	3.0
Overall	11.6	4.0	3.7

Tab. 6: Proportion of the most responsible to most/second responsible party by age group and level of injury, 2001-2003

to expect child presence and to take appropriate manoeuvre in advance. High culpability of fatally injured adults/older pedestrians may partially relate to alcohol involvement and lying on the road or loitering (shown in figure 3 and figure 4).

Type of Vehicle and Injury to Pedestrian

Type of Car and Severity of Injury

Larger vehicle mass, faster vehicle speeds, vehicle geometry (particularly front-end design) and stiffness are said to be the main factors to aggravate pedestrian injuries. Among registered vehicles in Japan, the percentage of conventional sedan has been decreasing while the proportion of mini-cars, minivan, wagon and SUV has been increasing. The Increase of heavy, larger cars such as minivan, SUV and wagon is of particular concern for pedestrian injury. In 2003, about 60%

of cars that hit pedestrians were sedan. The Combined proportion of minivan, wagon, SUV and Sports & Specialty that hit pedestrians adds up to 35%. Once these types of car hit pedestrians, the fatality rate is considerably high compared with sedans. Figure 5 illustrates this: fatality rates sustained by Sports & Specialty, SUV and minivan are markedly higher than that of sedans. Fatality rates rise sharply at middle-aged about 50-54 years old and above.

Previous research in Japan reported that aggressivity of SUV and minivan are explained by their frontal shape (higher hood-edge or shorter nose) and stiffness, and by faster speed of Sports & Specialty [1-3].

Vehicle Speed and Level of Injury

One of these recent studies [3] indicates that the vehicle geometry could have larger effects on pedestrian injury, as average estimated vehicle speed before crash is actually lower for minivan than that of sedan. Despite its lower speed minivans are more likely to sustain fatal injuries to pedestrians compared with sedan, and this is because front the shape of minivan aggravates injury to pedestrians. Figure 6 shows the estimated vehicle speed just before the driver recognised the hazard by selected type of car for fatal/non-fatal injury. For non-fatal injury curves of 4 types of car are clustered, but speed of minivan and SUV were

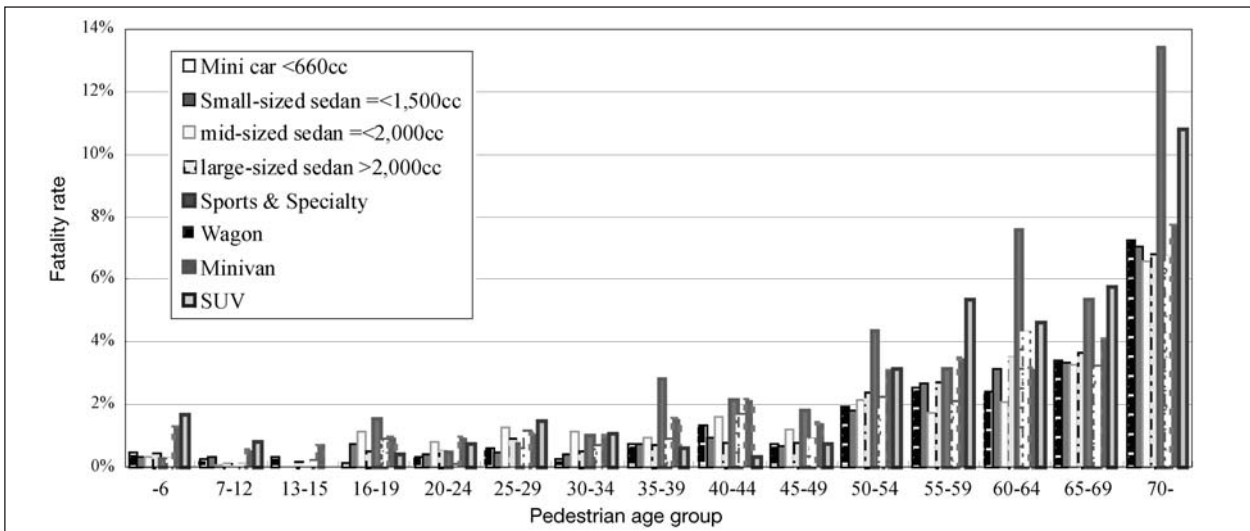

Fig. 5: Fatality rate of pedestrian by type of vehicle and age group, 2001-2003

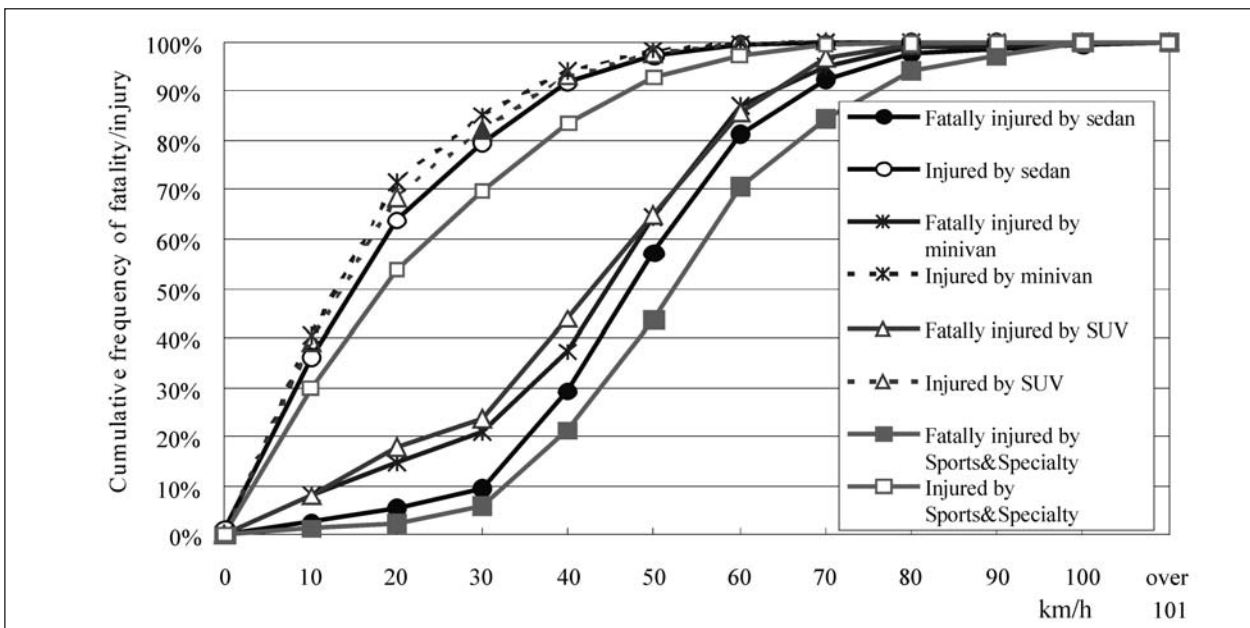

Fig. 6: Estimated vehicle speed by type of vehicle and level of injury, 2001-2003

slightly lower than sedan, whilst speed of Sports & Specialty was higher than sedan. The difference between types of car is more marked in fatal injuries. At 50th-tile, the speed of SUV and minivan is approximately 2-5km/h lower than sedan, whereas the speed of Sports & Specialty is about 5km/h higher than sedan. These results generally support those shown in previous studies. Higher hood-edge of SUV and shorter distance from bumper to windshield of minivan are likely to affect adversely on the impact point and the trajectory of pedestrians and thus consequences of injury. On the other hand, the higher speed of Sports & Specialty is likely to be the major factor to increase the fatality rate of pedestrian.

The most frequent pedestrian injury is to leg, but it is to head in fatal injuries. Head injury is often caused by hitting the head against the road surface, windshield frame or A-pillars. Leg injury is often caused by hitting the lower limb against the bumper [1, 2]. Measures in relation to injury protection of head and leg are briefly reviewed in the following section.

Relevant Measures

Vehicle Safety

Test Procedures for Vehicle Structure

Japan has been actively involved in recent activities in developing test procedures of vehicle structure aiming at pedestrian protection in collaboration with Europe and the United States. Various organisations have proposed test procedures: the European Enhanced Vehicle-safety Committee (EEVC), International Standards Organisation (ISO) and International Harmonized Research Activity (IHRA) and United Nations' WP 29 (World Forum for Harmonization of Vehicle Regulations). Test procedures of pedestrian protection in view of head/leg injury have been incorporated into EuroNCAP since 1997. In Japan, test procedures of head protection were incorporated into Japan NCAP in 2003. After September 2005, all new cars (with a few exceptions) and goods vehicles of 2.5 tonnes and under will be required to satisfy designated criteria by having a structure or hood material to absorb impact. In recent studies in Japan, data of ITARDA has been utilised in providing real-world crash information and in estimating effects of test instruments or procedures.

Given that most pedestrian injury is to leg, test procedures of leg injury protection are indeed of importance. In Japan, research on test procedures of leg injury protection has been under way, and the test instrument 'Flex impactor' is considered to be of most validity in reconstructing fracture patterns below knees in addition to problems of knee joints [4]. It should be also noted that research on the development and evaluation of a pedestrian dummy prototype has been actively conducted in Japan [5].

Other Technological Developments

There have also been various attempts to apply new technology including the area of active safety. Advanced Safety Vehicle (ASV) project has been promoted since 1991 with a leadership of the Ministry of Land, Infrastructure and Transport. 'Infrared sensor to detect pedestrians before crash' and 'pedestrian airbag' aiming to cover A-pillars to avoid direct contact with the pedestrian body, are examples to name a few. However, it is expected to take at least a couple of years before the technology is put into practical use [6].

Engineering and Education

Environmental Issues for Pedestrians

The most significant environmental problems concerning vulnerable road user safety in Japan is perhaps a lack of adequately dedicated space separated from carriageway due to mixed or undifferentiated road use. The most imminent problem for pedestrians is lack of pavement, which often leads to situations where they have to walk on narrow space only divided by a white line beside carriageway.

Pedestrian crossing facilities in Japan are mostly crossings with zebra markings, and they can be with or without traffic signal. Flyovers, most of which were constructed in the past days, are not widely used today. Central refuge is rare to be seen. The accident data shown in table 4 explained that about 30% of pedestrian accidents were 'crossing accidents occurred at crossing', and most of them occurred at light-controlled intersections. Most typically drivers did not recognise pedestrians or failed to give way at crossings while they were proceeding according to the green light. This suggests that serious problems between crossing pedestrian and driver lie in light-controlled intersections.

Area-wide Engineering Scheme to Protect Vulnerable Road User

In 2003, the Japanese government embarked on the 5-year project Safe Walk Zone. It started by designating about 800 residential/commercial areas with high accident frequency. It aims to improve road traffic environment by engineering treatment and to reduce accidents of vulnerable road users by 30%. Relevant measures include (a) improvement of physical environment (installation of pavement, street lighting and dedicated right-turning lane), and (b) introduction of improved traffic control (installation of traffic light – LED light in particular, introduction of complete pedestrian protect phase, and extended green phase for infirm people), and (c) other traffic calming schemes [7]. Other similar area-wide schemes aiming to improve walking environments for infirm road users, for example, have been introduced as well [8]. A complete pedestrian protect phase would be very effective in reducing accidents of crossing pedestrian vs. right-turning vehicle, as it is supposed to be human error proof unless drivers ignore the light since drivers will be freed from relying solely on their alertness to recognise pedestrians when approaching a crossing.

Education and Enforcement

Educational measures for pedestrians have been targeting children or older people mostly by giving occasional lectures. Lectures for children are usually given at kindergarten or schools by police officers or teachers. A gathering of older people is sometimes organised to give a lecture taking advantage of leisure activities through sports/hobby clubs. There are other positively sounding schemes such as community-based activities using accident mapping by residents and educational programmes involving three generations. Educational programmes targeting parents/grandparents for child safety are not widely implemented, but more could be done to raise awareness to protect children given their high risk of injury. Furthermore, older people may appreciate more practical information such as walking in relation to health issues or various transport service available to them besides traffic rules teaching.

Summary and Discussion

The analysis of traffic accident data showed:

- (1) The population-based age and sex comparison shows that the risk of injury as pedestrian is highest for boys and older women, whilst the risk of fatal injury is extremely high for older men and women.
- (2) Child pedestrians were over-represented in accidents on municipal roads, whereas older pedestrians were slightly over-represented in accidents on national/prefecture (N/P) roads that include most arterials except for motorway. The speed of vehicles that hit pedestrians was generally lower on municipal roads compared with N/P roads, and this could contribute to the lower fatality rate of child pedestrians and higher fatality rate of older pedestrians.
- (3) Sixty percent of pedestrian accidents were 'crossing accidents', and most of them occurred at/near intersections. Crossing accidents of children, however, are different from accidents of adults or older pedestrians. Children were more likely to be hit when they were crossing the road outside crossings, whereas adult/older pedestrians were more likely to be hit when they were crossing within crossings at/near intersections.
- (4) Children tended to dart out or cross the road improperly (in a way that it is nearly impossible for the driver to recognise them and avoid an accident) and collide with a vehicle proceeding straight. Possibly due to frequency of darting out violation, children were more likely to be judged to be culpable than adult or older pedestrians. High culpability of fatally injured adult/older pedestrians could be related to alcohol involvement.
- (5) In case of crossing accidents colliding against vehicle going straight at intersection, many adult pedestrians were found to cross the road improperly or ignore the light. However, many older pedestrians were found not to violate the laws, and red-light running was less frequent compared with adults. Most drivers who hit pedestrians, on the other hand, were found not to carry out general safe driving duties, and red-light running was far fewer than this.
- (6) In case of crossing accidents colliding against right-turning vehicle at intersection, most

pedestrians were found to be lawfully crossing the road, whilst most drivers failed to fulfil general safe driving duties or failed to give way to pedestrians. Red-light running by drivers did not emerge as one of the major violations.

- (7) The particular type of vehicle is known to incur more serious injury to pedestrian once they hit them compared with sedan. Among all, minivan, SUV and Sports & Specialty are more lethal once they hit pedestrians. The fatality rate of pedestrian becomes markedly high and particularly so with increasing age of the pedestrians. The major factor is considered to be front-end geometry of minivan and SUV and high speed of Sports & Specialty.

Compared with other industrialised countries, the proportion of pedestrian fatalities in Japan is very high. There are many factors related to this, but poor road environment and subsequent ambiguity in right-of-way discipline in vehicle-pedestrian interaction seem to be the major characteristics that make pedestrian accidents in Japan peculiar. It is commonly observed that drivers do not give way to pedestrians at pedestrian crossings without light, and pedestrians do expect that drivers may not stop at such crossings. Accidents of right-turning vehicle colliding with pedestrian at crossings while green lights appear for both pedestrians and drivers may also be such examples to illustrate the ambiguity in the right-of-way discipline. Engineering treatment such as complete pedestrian protect phase is expected to help reducing such conflicting situations.

The evidence suggests that physical abilities of children have been declining owing to increasingly sedentary life style and perhaps fewer distances walked over the years. It may well be that safety and environmental improvement for pedestrians may not be given the priority with increasing dependency on car. This is a common issue for other vulnerable road users such as older or infirm people. Traffic calming measures were rather recently introduced in Japan, but if appropriately implemented, they are expected to play an important role in improving walking environment in general and in reducing vulnerable road users casualties.

Acknowledgments

We would like to thank Hiroyuki MIZUNO of Japan Automobile Standards Internationalization Center (JASIC) for his advice and sharing valuable information on vehicle safety.

References

- 1 Institute for Traffic Accident Research and Data Analysis, Traffic Safety and Nuisance Research Institute and Nagoya University, 1999: Report on pedestrian accidents for pedestrian injury mitigation (in Japanese)
- 2 Institute for Traffic Accident Research and Data Analysis, 2002: Report on analysis of in-depth traffic accident data (in Japanese)
- 3 MIZUNO, K., KAJZER, J., 1999: Compatibility problems in frontal, side, single car collisions and car-to-pedestrian accidents in Japan. *Accident Analysis & Prevention* 31, 381-391
- 4 KOUNOSU, A., TANAHASHI, M., 2003: Development of a biofidelic flexible pedestrian legform impactor, 47th Stapp Car Crash Journal 47, 459-472
- 5 SUGIMOTO, T., AKIYAMA, A., SARUWATARI, H., 2000: Transportation and safety in Japan - safety technology developed by Honda R & D Co Ltd., *IATSS Research* 24-2, 102-105
- 6 Ministry of Land, Infrastructure and Transport, 2002: Proceedings of 3rd symposium for automobile safety, Ministry of Land, Infrastructure and Transport (in Japanese)
- 7 National Police Agency, July 2003: <http://www.npa.go.jp/koutsuu> (in Japanese)
- 8 National Police Agency, 2002: Road traffic situations and measures (in Japanese)

J. P. Dias
 IDMEC – Department of Mechanical Engineering,
 Instituto Superior Técnico,
 Technical University of Lisbon, Portugal

Accidents Involving Motorcycles and Pedestrians in Portugal

Abstract

Portugal has the highest rate of road fatalities in Europe (2002 and for Eur-15 - CARE database). For this highest rate, the accidents involving pedestrians and motorcycle occupants have a higher contribution than the European average.

In the last years, especially accidents involving motorcycles have been investigated and currently two different projects are being carried out, one related with motorcycles accidents and the other with pedestrian accidents. In these projects, countermeasures among others to reduce the fatalities between these two types of road users are being studied.

These accidents are investigated with the commercial accident reconstruction software PC-CRASH but also new methodologies based on multibody dynamics are in development in order to more accurately study these two types of accidents. In this paper, the methodologies in use for accident reconstruction and new methodologies in development are presented.

Speeding has been found to be one of the major causes of road fatalities for pedestrians and motorcycle occupants. In the case of motorcycle accidents, these involve mainly young drivers. Aspects as social behavior are also important to understand the causes of some of these accidents. Some examples of accidents occurring in Portugal, involving especially motorcycles and pedestrians are presented and discussed.

Notation

TWMV Two wheels motor vehicle
 OV Other vehicle

Introduction

In 2003, according to the Portuguese accident data, 41495 accidents with injuries occurred, 1498 persons died (within 30 days: correction factor = 1.14), 4659 severe and 50599 slight injuries occurred. Portugal is one of the European countries with higher rates of road fatalities and accidents. These numbers are unacceptable in a social viewpoint, and the socio-economical cost for the country is estimated between 1498 and 5385 million Euros. The reduction of the Portuguese road fatalities involves among others countermeasures the in-depth study of the road accidents. The development of methodologies for the study of road accidents is very relevant for a wide group of entities, from the legislators, the traffic police, the courts, the insurance companies and for all the victims and relatives involved in road accidents. The accidents involving motorcycles and pedestrians represent, in Portugal, about 40% of all injuries. The statistical data for the year 2003 is presented in table 1, where the motorcycles have been separated in two groups; moped or scooter vehicles with engine size lower than 50 cm³ and motorcycles having an engine size greater than 50 cm³. The conditions namely driver license and qualifications required for these two types of motorcycles are quite different.

In the Portuguese statistics only three levels of injuries are recorded (fatal, serious and slight). A more accurate classification of injuries such as AIS is necessary. European harmonization requires homogenous definitions to establish meaningful comparisons.

	Injuries					
	Fatal(*)	% of Total	Serious	% of Total	Slight	% of Total
Moped (<50cm ³)	138	10.2	628	13.5	5482	10.8
Motorcycles (>50cm ³)	187	13.8	585	12.5	4086	8.1
Pedestrians	274	20.2	902	19.4	6326	12.5
TWMV + Pedestrians	599	44.2	2115	45.4	15894	31.4
Total (For all vehicle types)	1356		4659		50599	

(*) Fatalities on accident scene according the Portuguese statistics

Tab. 1: Injuries involving pedestrians and motorcyclists in Portugal 2003 [1]

When comparisons are made between Portugal and other European countries [2], Portugal has 11.2 deaths per 10000 two wheels vehicles (2001 data), when other south Europe countries have rates as Spain 2.5, France 2.2 and Italy 1.7. Unfortunately there are no more accurate statistics for the two wheel vehicle such as rider deaths by motor vehicle kilometers.

Another interesting fact from the statistics is that Portugal has the highest share of frontal collisions in EU-15 (data from 1992-1995 [3]) of 21.5% when in Spain the frontal collisions only represent 5.4% and in Italy 7.6%. In the data presented in [3], Portugal presents the second highest fraction of injured motorcyclists per total injuries. This fact has to be deeply investigated and one of the causes that can lead to this situation can be, in addition a large quantity of frontal impacts, related with the speed.

The in-depth study of the accidents involves motorcyclists in a current issue in Europe that is illustrated by the European Project, MAIDS [4]. Unfortunately in this project Portugal has not been involved but all the detailed methodologies and knowledge from this project are to be considered in the in-depth study undergoing. Other in-depth research reports concerning motorcycle accidents have been conducted, namely the work of HURT [5] who founds for instance and increasing risk of motorcycle injuries related with speed.

The in-depth analysis of accidents involving pedestrians is another issue of concern, because they represent about 20% of the road fatalities in Portugal. Education efforts on education and the change of the behavior of pedestrians [6] and measures to modify the social environment are some of the measures that have been analyzed to reduce the number of pedestrians injured. The characteristics of the persons involved in accidents and the circumstances of the accidents have proved [7] to be very important to the understanding of these phenomena. Speed and crash severity for pedestrian accidents are found to have a strong connection by GARDER [8].

The work presented hereunder in just the preliminary approach of two in-depth research projects of accidents involving motorcycles and pedestrians will be carried out with the financial support of the Allianz Portugal, DGV (Portuguese Directorate-General for Traffic) and PRP (Road Safety Prevention Institute).

Methodologies

The methodologies for the study of accidents involving motorcycles and pedestrians, presented hereunder, are based on the following steps. The starting point is the information from the police reports that include the more relevant data including diagrams and other information required for the reconstruction. The information contained in the police reports is sometimes incomplete, and one of the aims of this undergoing work is also to collaborate with the police and traffic authorities in order to improve the quality and the quantity of the data collected at the crash scene. Next, when some information is missing or some questions arise, the vehicle (if still available) has been mechanically inspected in order to detect mechanical failures or malfunctions and also evidences related with the contact between vehicles or vehicle and road users. From these data, a 3D accident reconstruction has been performed, as in the cases presented hereunder using the software PC-Crash [9]. All the data resulting from the reports and accident reconstruction is included in a Microsoft Access database. Of course a detailed 3D accident reconstruction is almost impracticable to do for all the accidents occurring. In the future also non-accident population is to be included. Regarding motorcycles, the on-scene in-depth motorcycle accident investigations methodology by the OECD [10] will be adopted.

Accident Reconstruction

In opposition to automotive vehicles where the pre and post-crash movement is in the majority of the cases planar, motorcycles have frequently three-dimensional motions and sliding/skidding during fall down. Due to these three-dimensional motions the classical accident reconstruction techniques based on deformation or speed from skid and sliding marks can lead to erroneous results. Also the estimation of speed from skid marks should be used carefully because a significant number of the drivers in an emergency situation only use the rear brake. One example is presented in figure 1. Based on the deformations presented by the vehicle (left side showing evidence of an impact), one expert concluded that the moped vehicle was doing a U-turn. However the reconstruction of the motion shows that the moped was traveling in the same

direction as the car that hit it. Two frames of the accident showing the rotation of the moped are presented in figure 2.

The accurate reconstruction of accidents involving motorcyclists and pedestrians requires the use of three-dimensional models. These models are necessary to reproduce the motion of the vehicles as also to estimate the injuries in pedestrians and to correlate them with the medical reports in order to allow the determination of the vehicles' speeds.

Multibody dynamics models are used in many fields, from vehicle dynamics, human body models to crashworthiness. These models are to be adapted to accident reconstruction of motorcycle accidents, giving a more reliable description of the vehicles' pre- and post-crash dynamics, and will include also models for occupants such as the Madymo models [11].



Fig. 1: Moped damage

Motorcycle Accidents: Case Study

In table 2 some relevant data for eleven accidents involving motorcycles having occurred in Portugal are presented. The results are yet preliminary and are not fully detailed. These examples are mainly cases where the reconstruction has been required by courts in litigation processes, because the rider die or because conflicting statements supplied by the witnesses or persons involved in the accident are observed.

The accident reconstruction has been carried out using three-dimensional reconstruction techniques that have been briefly described in the previous section. The determination of the impact speed and the pre-impact direction of the vehicles is a crucial point that is requested by courts. In the data presented, it can be observed that only in one case no helmet use is observed. This agrees with the Portuguese statistics that reveal that the helmet use is greater than 90%. Alcohol use is considered one of the major causes of accidents in Portugal. However in this sample only one case has been detected, in which curiously both drivers were drunk. In the cases presented, accidents involve motorcycles and several types of other collision partners, from trucks to forklifts. The most surprising accident in this sample is the collision off-road between a moped and a motorcycle. The two occupants of the moped vehicle die and the occupant of the motorcycle has been severely injured. No vehicle has insurance and the motorcycle does not have even a license plate and registration.

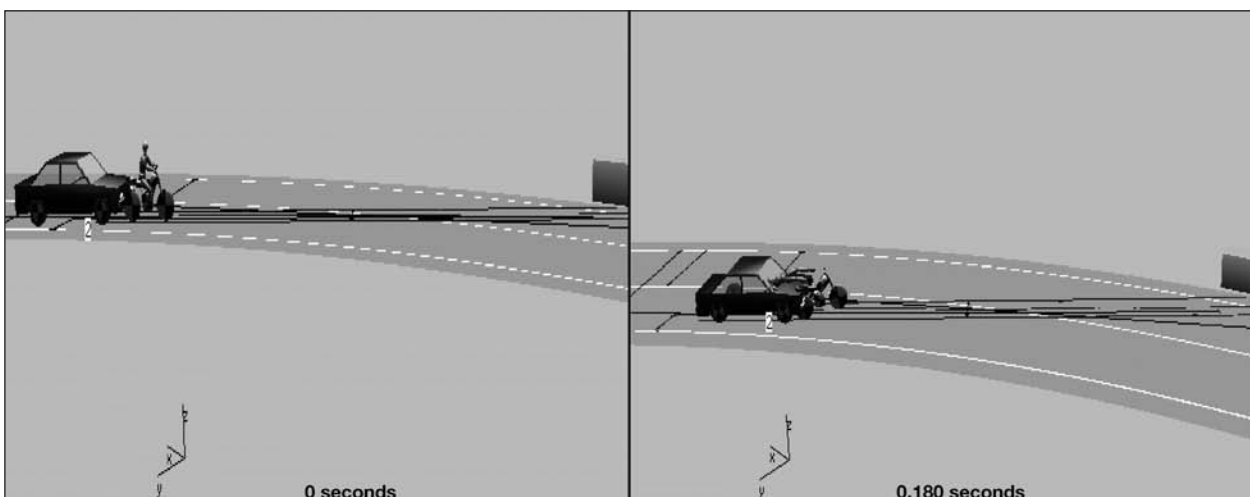

Fig. 2: Reconstruction of an accident involving a moped vehicle

CASE N.	Helmet Usage	Alcohol Use	Vehicle Type	Collision Partner	Motorcyclist Injuries	Motorcycle Speed	Speed Limit	Primary Contrib.	Day-time	Weather
1	Yes	NA	Moped	Truck	Severe	30	50	Motor.	Day	Dry
2	Yes	Yes	Motor.	Truck	Fatal	110	50	OV	Night	Dry
3	Yes	No	Motor.	Car	Fatal	75	50	OV	Night	Dry
4	Yes	No	Moped	Car	Fatal	15	90	OV	Day	Dry
5	No	No	Moped/Motor.	S/M	Fatal (2)	40/25	NA	Motor.	Day	Dry
6	Yes	No	Motor.	Car	Fatal	145	50	Motor.	Day	Dry
7	Yes	No	Motor.	Forklift truck	Fatal	150	90	Motor.	Day	Dry
8	Yes	NA	Motor.	Car	Minor	30	50	OV	Night	Dry
9	Yes	No	Motor.	Car	Minor	45	50	OV	Night	Dry
10	Yes	No	Motor.	Guard rail	Fatal	115	90	Motor.	Day	Dry
11	Yes	No	Motor.	Truck	Fatal	127	50	Motor.	Day	Dry

Tab. 2: Motorcycles accidents in Portugal: case studies



Fig. 3: Motorcycle license plates in some European countries the (Portuguese one is on the left side)

Even if the primary contribution for the accident is the other vehicle driver, speed plays a crucial role in the severity of the accident. For the nine fatalities presented, speed above the limits was observed in six cases. The typical profile of the drivers of the moped vehicles involved in the accidents presented are very young boys or older men. The license qualifications to drive a moped vehicle in Portugal are very easy to obtain because only the basic notions of the road laws are required. In addition concerning motorcycles the typical driver is a 20-30 year old male.

One of the aspects related with speed enforcement is the dimension of license plates. In Portugal they are quite small, and are sometimes hidden or intentionally deteriorated or presenting small sizes that are legally specified. Because of this the enforcement of speed and impaired driving laws becomes difficult. The behavior which breaks the traffic rules is an element of risk causing road traffic accidents [12].

For the data presented all accidents occurred at good weather conditions and some of them at night.

The in-depth mechanical inspection of the vehicles is very important. Some details are not registered in

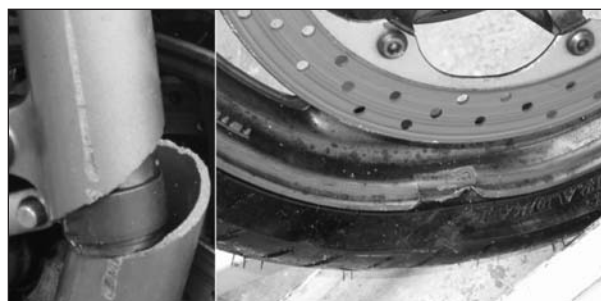

Fig. 4: Mechanical failure of motorcycle components

the police reports but sometimes they play a crucial role for the determination of the accidents causes. Traffic police reports usually do not contain detailed information to fully understand the causes of the motorcycles accidents. Detailed photographs are in the majority of the cases absent and also a mechanical inspection of the vehicles is not performed. As an example in figure 4 the photographs of a frontal damper failure are presented. Initial suggestions are that this fatal accident has been caused by a mechanical failure. A more detailed inspection of the vehicle and guard rails and the 3D reconstruction of the accident have shown that the mechanical failure has been caused by a violent impact against the vertical beams of the guard rail. The scratch presented in

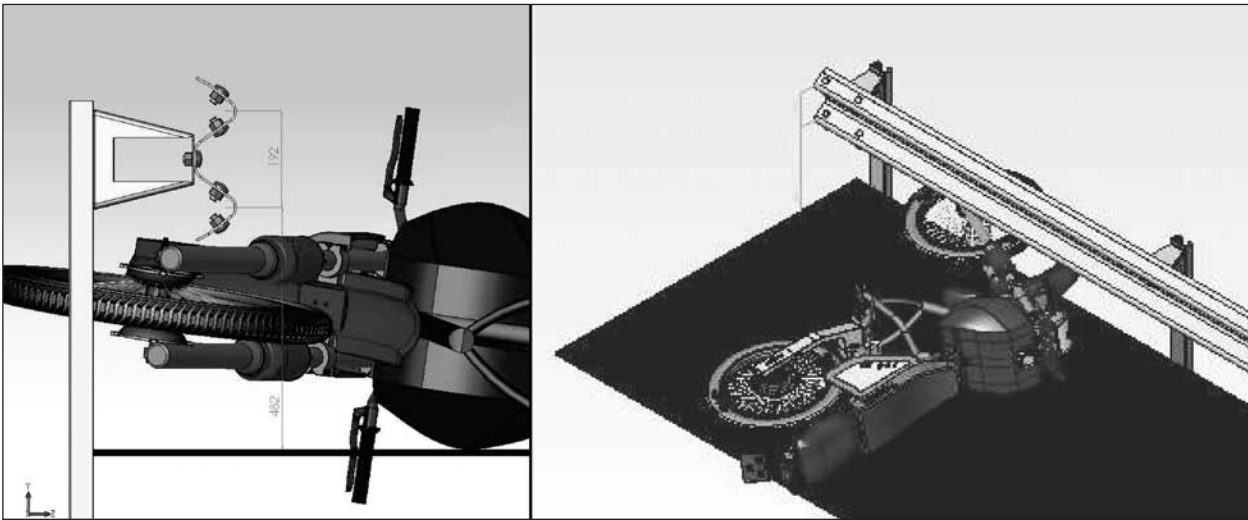

Fig. 5: CAD 3D models for accident visualization

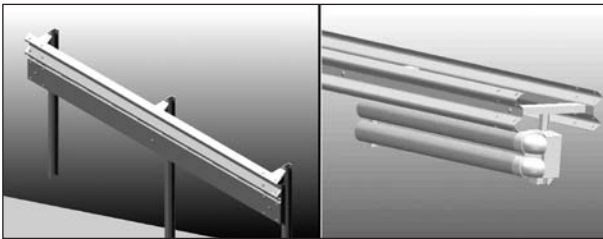

Fig. 6: Guard rail models for motorcyclist protection

the mechanical component has been caused by the sliding of the structural parts of the motorcycle into the lower part of the W beam of the guard rail. Scientific visualization tools or even CAD 3D models can be used to illustrate these aspects of the accident, as indicated in figure 5.

The reconstruction of motorcycle accidents is a difficult task. The information about crash-tests is limited and the commercial accident reconstructions available sometimes have some difficulties dealing with some accident scenarios. In addition to the necessary crash data, multibody dynamics models can give an important contribution providing a more accurate modeling of the pre- and post-crash dynamics of the vehicle as also to include crashworthiness description. We are currently developing these types of models. The protection of motorcycles in the impact with guard rails is under investigation, in order to provide guidelines for the design of the road and necessary location of these motorcyclist protections. Also with regard to the limits of survivability (speed and angle) in collisions motorcyclist guard rails are to be found.

Pedestrian Accidents: Case Study

The rate of accidents involving pedestrians, in Portugal, is comparatively higher than in the other European countries. In figure 7 the pedestrian deaths in Europe are presented. As can be observed Portugal has the highest fatality rate per population in Europe-15 when the data is normalized using the population.

In opposition to Europe where the majority of the pedestrian fatalities are in the age group of children and younger, in Portugal the most important group of risk are the older persons as can be observed in figure 8.

A very large portion (about 90%) of the pedestrian fatalities occurred in urban areas.

In table 3 two cases of pedestrian accidents analyzed with the described methodologies are presented.

The accidents already analyzed concerning pedestrians are for now very limited. However in the two cases presented, because no witnesses saw the accident, it was necessary to compare the medical reports with the injuries values calculated from the simulations. Case 2 presents a case where the car hit an older pedestrian at a cross-road at night in an urban area. The excess speed was only 5km/h but the impact speed was large enough to cause the death of the older person due to the violent impact on the ground. Visibility of pedestrians is one of the concerning issues as also the traveling speed of the vehicles in urban areas. Another aspect that is to be analyzed is car's age that is, in Portugal, one of the highest in Europe.

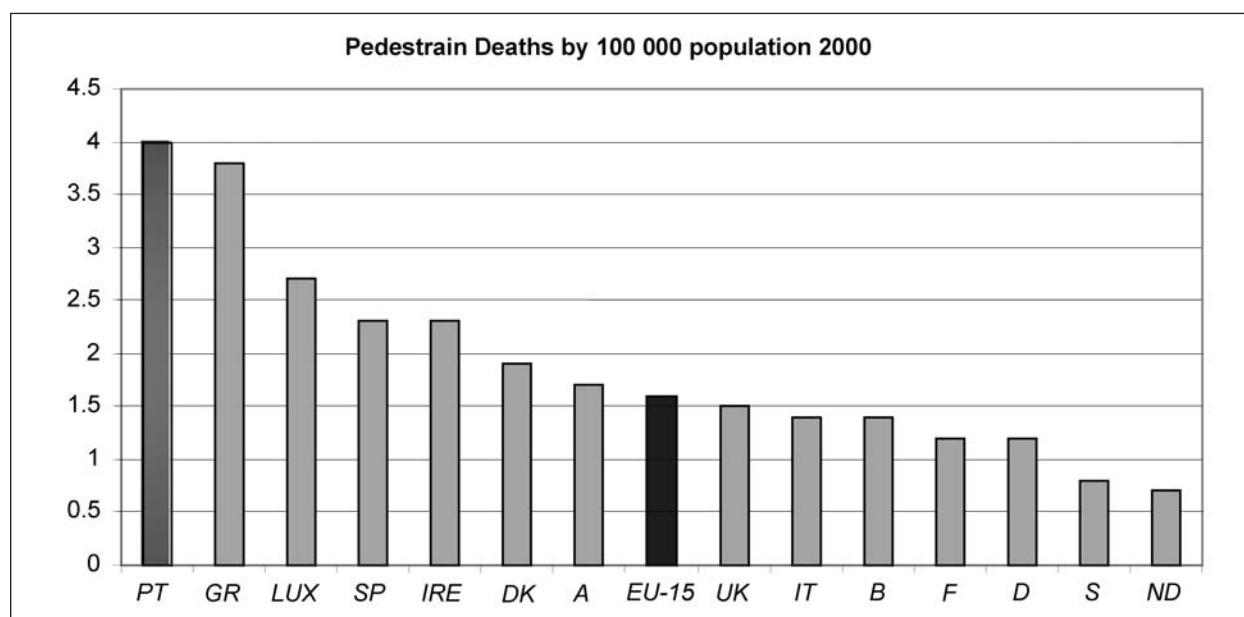

Fig. 7: Pedestrian fatalities in Eur-15 in 2000 (Source IRTAB)

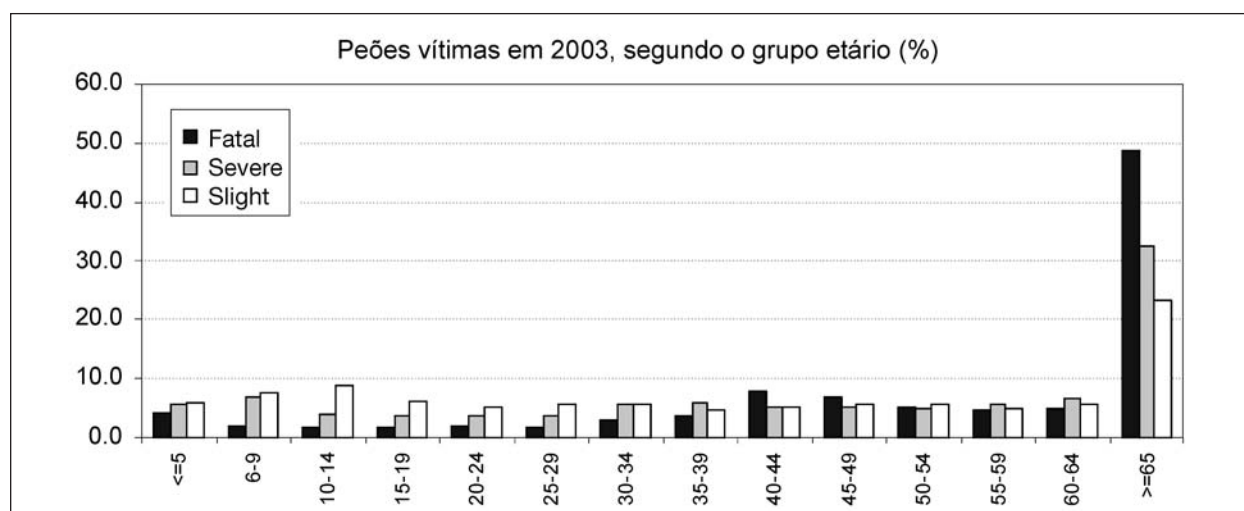

Fig. 8: Pedestrian fatalities in Portugal by age group

CASE N.	Pedestrian Age	Pedestrian Fatality	Vehicle Type	Impact Speed	Speed Limit	Primary Contrib.	Light	Weather
1	42	No	SUV	40	50	Driver	Day	Dry
2	75	Yes	Car	55	50	Driver	Night with public lights	Dry

Tab. 3: Pedestrian accidents in Portugal: case studies

The last years' improvements in vehicle safety, in particular to protect pedestrians, have some impact especially in the consequences of the impacts.

On urban roads in Portugal, data about the traveling speeds show that 70% of the drivers exceed the speed limits. Impact speed has a major influence on injury outcome. The influence of the vehicles speeds in the consequences of the

accidents is a very important aspect to be deeply analyzed.

Discussion

Pedestrians and motorcyclists are worldwide two groups of risk. However in Portugal, the contribution of these groups to the overall injuries is much higher than the European average. From

the accidents already analyzed especially involving motorcycles, speed has an important contribution to the severity of the injuries.

From this work countermeasures to reduce the number of fatalities are to be proposed. Some aspects already identified include the dimensions and the visibility of the license plates, the riding training for motorcyclists, rider qualification and training in emergency situations and speed limit enforcement.

Concerning pedestrians, their improper actions are problematic. Education can be a good solution for kids and younger persons but it is very difficult to apply to older persons (60 years and more), so special countermeasures for this group of risk have to be analyzed. Illegal and dangerous parking of the cars as also a better design of the urban roads for pedestrian protection are also aspects that have been identified but their contribution to the injuries of pedestrians must be quantified.

For the in-depth study of accidents and accurate reconstructions of these accidents the data collected by the authorities are very important. Procedures to more accurately collect the information such as scale-diagrams elaborated with CAD software, more detailed reports including more specific data related with motorcycles and pedestrians, detailed photographs of the vehicles on the scene as also of the accident scene and obstacles or barriers are necessary.

An accurate reconstruction to accidents involving pedestrians and motorcyclists requires 3D reconstruction tools as also biomechanical models. Also the increase of the quality of the computer models and the development of new formulations, procedures and models with tools and methodologies from multibody dynamics, vehicle dynamics, crashworthiness and even optimization are two of the objectives of the work going on.

The issues already identified as important for the determination of crash risk and influence in accidents include for motorcycles:

- Daytime headlights for motorcycles are mandatory, but not always respected by motorcyclists.
- License plates for motorcycles have small dimensions when compared with other European countries, and sometimes hidden or

intentionally deteriorated license plates are detected on Portuguese roads.

- The Portuguese legislation is not clear if illumination of the license plates is mandatory or not, and an important number of motorcycles do not have it.
- Turn-lights are sometimes neglected.
- Mirrors are not mandatory.
- No limits for the top speed or engine power of motorcycles are mandatory. The risk of injury versus engine power is to be evaluated.
- Moped or mofa vehicles are limited by law at an engine size lower than 50cm³ or a top speed of 45km/h. Tampered vehicles are to be investigated.
- A regular mechanical inspection is not mandatory for two wheels vehicles. The influence of mechanical malfunctions or the quality of critical parts such as tires in accidents is to be included.

Other issues related with pedestrians

- The number of pedestrians respecting traffic lights and crossing outside crosswalk areas (when they are available) is by simple observation poor and is to be quantified.
- The conditions and characteristics of the roads in zones of accumulation of accidents of pedestrians are to be investigated.
- The effect of a higher vehicle age when compared with other European countries and its effect on the severity of the injuries.

Ongoing and future measures to conduct an in-depth study of the accidents

- Collaboration with the traffic police and traffic authorities in order to improve the quality of the accident reports, diagrams and sketches, and accident databases. For instance the accident databases present the same lacks concerning accidents involving motorcycles and pedestrians.
- Video surveillance of accident scenes to collect information about the behavior of motorcyclists and pedestrians in these areas. Digital video and digital photographs will provide a more

relevant data including behavior of pedestrians and motorcyclists, environment conditions and their contribution to the accidents which can also be used to estimate the speed of the vehicles in these areas.

Acknowledgements

The support by the Allianz Portugal, DGV (Portuguese Directorate-General for Traffic) and PRP (Road Safety Prevention Institute) is gratefully acknowledged. Also the collaboration of the students Patrícia Freitas, Ricardo Portal, Rui Silva, Miguel Roque and Pedro Lima is appreciated.

References

- 1 Portuguese Directorate-General for Traffic (DGV): Road Statistics 2003 (in Portuguese available at www.dgv.pt)
- 2 MASUREL, P.: Investigating explanatory factors in fatality trends and rates between EU countries investigating differences in definitions and collection procedures, Transport Statistics: Road Safety, Department for Transport, United Kingdom, 2003
- 3 STEFAN, C., HÖGLINGER, S., MACHATA, K.: Case study: Motorcycle accidents, KfV – Kuratorium für Verkehrssicherheit, Austria, 2003
- 4 Maids Project: Final Report 1.1, 2004
- 5 HURT, H. H., QUELLET J. Z., THOM, D. R.: Motorcycle accident cause factors and identification of countermeasures. Technical report, Vol. 1. US Department of Transportation, National Highway Traffic Safety Administration, Washington, DC, 1981
- 6 FONTAINE, H., GOURLET, Y.: Fatal pedestrian accidents in France: a typological analysis. *Accident Analysis and Prevention* 29 , 303–312, 1997
- 7 HARRUFF, R. C., et al.: Analysis of circumstances and injuries in 217 pedestrian traffic fatalities. *Accident Analysis and Prevention*, 30 (1), 11–20, 1998
- 8 GÅRDER, P. E.: The impact of speed and other variables on pedestrian safety in Maine. *Accident Analysis and Prevention*, 36, 533–542, 2004
- 9 PC-CRASH “A Simulation program for Vehicle Accidents”: Technical Manual, Version 6.2, 2002
- 10 OECD, Motorcycles: Common International Methodology for On-Scene, In-Depth Accident Investigation, Paris, OECD/DSTI/RTR/RS9/ICC, 2001
- 11 Madymo Software (www.madymo.nl)
- 12 ELANDER, J., WEST, R., FRANCH, D.: Behavioural correlates to individual differences in road-traffic crash risk: an examination of methods and findings. *Psychol. Bull.* Vol. 113, pp. 279–294, 1993

D. Margaritis, Y. W. R. de Vries, H. G. Mooi
TNO Automotive, Delft, The Netherlands

Accident and Injury Causation of Motorcycle Accidents

Abstract

Motorcycle riders are one of the most vulnerable road users. Annually, on estimate 6000 people are killed in motorcycle accidents in the former 15 EU countries. The objective of this research was to investigate and analyze the main aspects and causes of this vulnerability and the accidents in general. For this aim around 70 accidents in The Netherlands were investigated in the framework of an international research program (MAIDS). Also a control group of motorcycles with riders was investigated so that exposure could be taken into account. An important result is that human failure is in 82% of the cases the main cause of the accident, in 52% this is due the other vehicle driver. Perception and decision failures are the most common failures. The most injuries are caused by the environment but they are typically only less severe (AIS1). Injuries caused by the car (front and side) are typically severe injuries (AIS4+). Previous convictions of the MC rider seem to be related to the chance to get involved in an accident. It was shown that the Dutch and the total MAIDS accident sample are comparable.

Notation

ACEM	European Motorcycle Manufactures Association
AIS	Abbreviated Injury Scale
ar	Adjusted residuals
DART	Dutch Accident Research Team from TNO
IMMA	International Motorcycle Manufactures Association
MAIDS	Motorcycle Accident In-Depth Study
MC	Motorcycle
n	Number
OV	Other Vehicle
OECD	Organization for Economic Cooperation and Development
PTW	Powered Two Wheeler (motorcycle, moped or mofa)
SD	Standard Deviation

Introduction

More and more people are choosing the motorcycle as a way of their transportation. Its small size gives the advantage of easy maneuverability in the cities, moving through the jammed traffic and spending no effort for parking. The effect of that is the increased number of motorcyclists every year. Despite the many advantages that the motorcycle has as a vehicle, it has also disadvantages that have to be taken into consideration. The safety that it provides to the occupant is limited, in comparison to the safety that the 4-wheeled vehicles provide during an impact. The reason to that can be found in the motorcycle itself as a construction. The motorcycle has no cage and it can be seen as a bench on which the rider is sitting. The occupant separates most of the times from the PTW during an accident and he is exposed to any impact with environmental objects. High injury severity and high rate of mortality are the results. Approximately 6000 are killed annually in the former 15 EU countries (EU15). Also the risk riding a motorcycle is the highest per kilometer ridden when compared with other road traffic means (16 fatalities per 100 million kilometer as compared to 1.1 for all road vehicles).

Motorcycle accidents have been a major concern and the need for detailed information on the accident causes and the effect on the human lives increased during the last decades. In 1994, IMMA published a report concerning motorcycle safety. The report pointed out the need for an internationally harmonized in-depth method for the analysis of motorcycle accidents. In 1999, ACEM proposed the MAIDS study in order to fill the gap for detailed information of accidents of modern PTW's. Five different countries participated in the MAIDS study, whose collecting phase lasted two years. For The Netherlands, the DART of TNO Automotive was one of the five research partners. The study allowed the investigation of several parameters: the accident environment, the vehicles involved, the human factors, the accident causation and the injuries sustained. The analysis of these parameters could lead to the development of countermeasures for the prevention of motorcycle accidents and the reduction of their severity. In July 2004, ACEM published a report on the analysis of the MAIDS data and presented the first results [4].

In the next sections, the analysis of the Dutch MAIDS data can be found. The first sections describe the data collection method and the statistical analysis method that were applied by the DART. The sections there after describe the results and as last, the discussion of the findings and conclusions will be given.

Investigation Method

Accident Collection

From mid 1999 till the end of 2001, almost 1000 motorcycle accidents were collected in 5 European countries (France, Germany, Italy, Spain and The Netherlands) in the framework of the MAIDS project. A harmonized method of accident collection, accident reconstruction and parameter's codification was used in all 5 countries. The methodology was developed by OECD, particularly by a group of experts from the industry and major research institutes worldwide. The methodology was structured so that a basic module had to be used by all teams, but some additional modules were also developed, allowing a more detailed analysis of topics such as helmets and mopeds. The sampling plan required the investigation of every n^{th} accident, where n was kept constant for 24 hours, in an area representative to the national accident distribution. The inclusion criterion was that at least one PTW occupant had to sustain an injury. The research team visited the accident scene within 24 hours from the accident occurrence. Besides to the collection of accidents, an equal amount of case control data (comparison data from riders and motorcycles that were not involved in accidents) had to be collected. This method is known as "concurrent exposure". The data from the control group would be used to measure the occurrence of a given risk factor in the accident and in the exposure population.

The DART team operated in the police area of Rotterdam-Rijnmond and Haaglanden during the period September 1999 until October 2001. The sampling area was well representative to the national profile, considering that only the percentage of accidents on secondary roads was about 10% lower than the national figures and the percentage of passenger car accidents was slightly lower too. 200 accidents were investigated, from which there were 113 moped, 66 motorcycle and

21 mofa accidents. The data were obtained by visiting the accident scene, inspecting the involved vehicles, interviewing the victims, receiving police accident registration forms and technical accident reports, reconstructing the accident and calculating parameters such as vehicles velocity and vehicle motion and collecting medical data from the victims hospital dossier. For this reason, special contacts had to be established with 16 hospitals and the police force of the sampling area.

Parallel to the collection of accidents, the DART collected the concurrent exposure data too. 200 PTW were inspected and their occupants were interviewed. Petrol stations were selected randomly as the location where the concurrent exposure would take place. Before the start of the exposure, the DART contacted the petrol station owners and the head offices of the oil companies for their cooperation. From the 200 PTW controls, 151 are moped/mofa and 49 motorcycle controls.

Data Analysis

The data analysis was done by means of the SPSS computer program. Frequency counts and cross-tabulation routines were used. The chi-square test was used for detecting significant differences. The inspection of the adjusted residuals (ar) allowed the identification of significant under- or over-representation of a certain factor with respect to the other tabulated factors. When the adjusted residuals are below -2 or above 2 , the cell value deviates

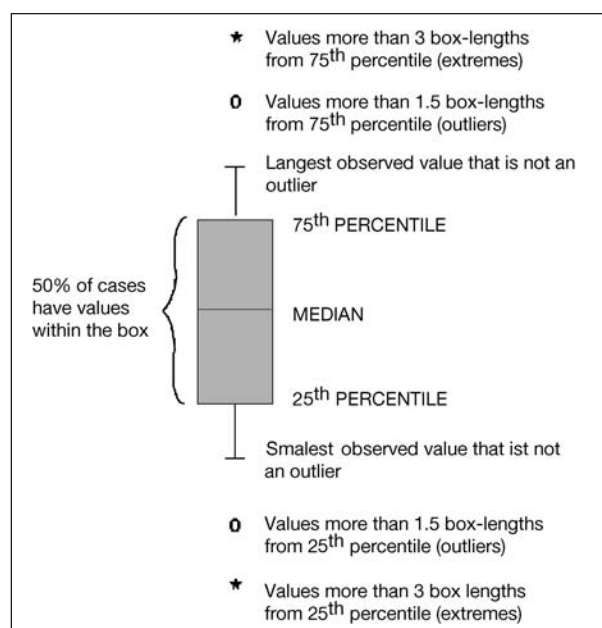

Fig. 1: Description of a box-plot

configurations. This large group is equally present in other accident configurations, and merely a product of exposure.

In the configurations “OV turning left in front of MC, MC perpendicular to OV path” (11%), two types of OV are frequently represented: passenger cars with a mass between 800kg and 2 tons (43%) and trucks and heavy goods vehicles with a maximum mass over 3.5 tons (43%). The last one was over represented ($ar = 2.9, n = 3$); so more presented than expected based on pure chance.

In the configuration “OV making U-turn or Y-turn ahead of MC” (9%), 83% of the OV are passenger cars with a mass between 800kg and 2t and they are over represented ($ar = 2.1, n = 5$); so more present than expected.

The configuration “MC falling on roadway in collision avoidance with OV” is part of the 29%

impacts with the roadway or an object. The most frequent involved party is the passenger car with a maximum mass less than 800kg (63%), which is over-represented ($ar = 3.7, n = 5$) and therefore more present than expected based on pure chance.

Human Factors

For the analysis of the human factors, both the accident and the exposure group were used. The analysis is focused on some of the general parameters, such as age, kilometers ridden, previous violations/accidents and alcohol/drugs use.

Age

To identify any differences in age distribution between the accident case population and the control group population an independent-sample t-test was performed, which shows whether two samples deviate from each other. A criterion for this test is that the sample is normally distributed, which is the case here. It should be stated that the t-test is even quite robust for small deviations from normal distributions. The t-test showed that the average age of the accident population is significantly younger (approximately 5 years) than the average age of the control population (see table 2 and figure 3).

The difference in distribution is however not caused by the youngest riders (less than 25 years old), but more in the range of 25 to approximately 30 years. The analysis of the whole MAIDS data shows that for the accident population, the majority of the riders are between the age of 26 and 40 years old (50%).

Driving Experience

For the kilometers ridden per year, the same strategy was applied as for the analysis of age. No significant difference was shown. It has to be mentioned that data were available only for 38 riders of the accident group.

For the number of days driven per year, there was a significant difference. The accident population drove approximately 60 days more per year than the control group (see figure 4, and table 3).

The difference found here seems to be quite large, and therefore the data was investigated more

		Rider age
		Equal variances not assumed
t-test for	t	-2.451
Equality of Means	df	84.917
	Sig. (2-tailed)	.016
	Mean Difference	-5.064
	Std. Error Difference	2.066
	95% Confidence Interval of the Difference	Lower Upper
		-9.173 -.955

Tab. 2: Independent sample t-test for age

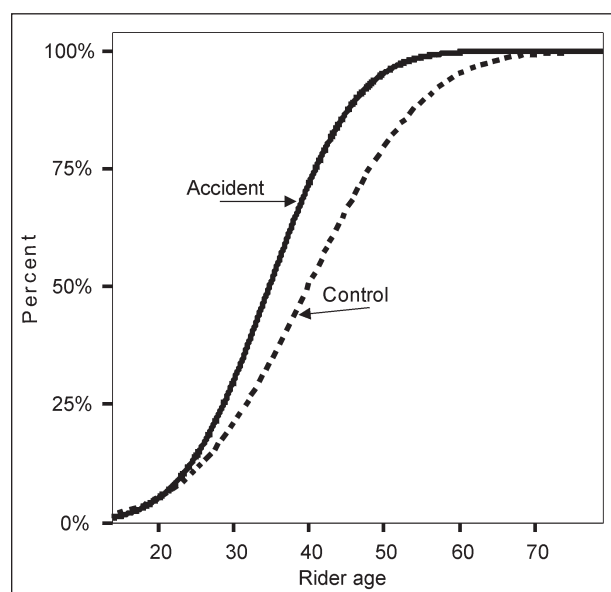

Fig. 3: Cumulative distribution of MC rider age

		Number of days ridden per year
		Equal variances not assumed
t-test for Equality of Means	t	2.906
	df	89.564
	Sig. (2-tailed)	.005
	Mean Difference	58.558
	Std. Error Difference	20.153
	95% Confidence interval of the Difference	Lower 18.517 Upper 98.599

Tab. 3: Independent sample t-test for days ridden per year

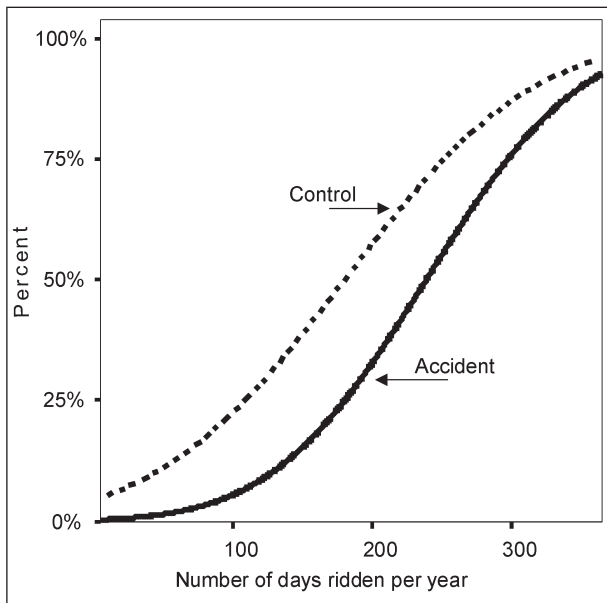

Fig. 4: Cumulative distribution of number of days ridden per year

thoroughly and conditions under which the data was acquired were inspected. This is further explored in the discussion section.

Previous Violations/Accidents

Looking at the previous violations of the last five years, it was found that in the accident group riders with two or more convictions are slightly over-represented ($\text{or} = 1.9, n = 22$) with respect to the control group (see figure 5). Consequently, slightly less riders in the accident population had less than one conviction. Data were available for 48 riders of the accident group. This factor was inserted in the GLM model together with the already known influential factors age and number of days driven per year (and kilometers driven per year). It was found that the factor previous violations on record increased the significance of the model ($p < 0.01$) for the prediction of an accident. Two or more previous violations on record gave a significantly higher probability to be in the accident population.

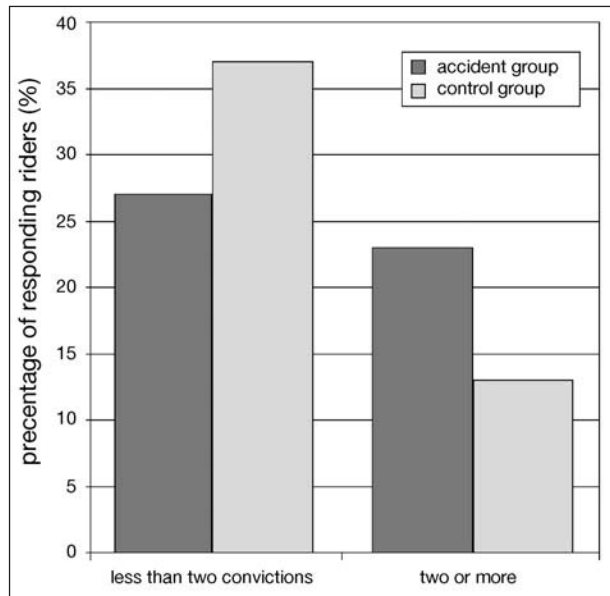

Fig. 5: Comparison of the number of convictions of the last five years between accident and control group

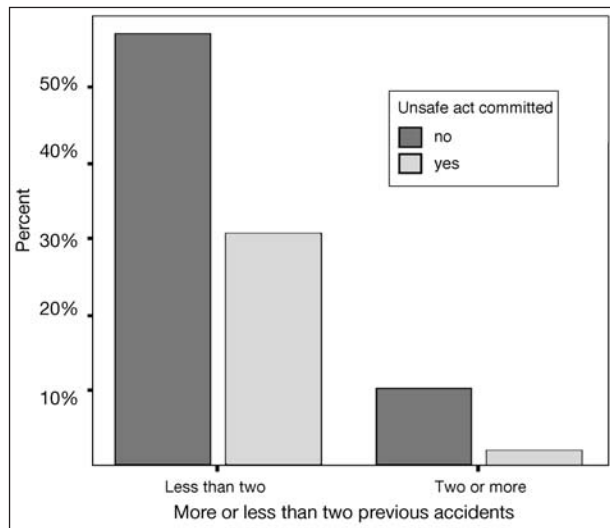

Fig. 6: Comparison of the number of accidents for MC riders who committed (or not) an unsafe act

No such significant difference was found for the riders with previous accident involvement (less or more than two) in the last five years in the accident and exposure group. 49 riders of the accident group responded to this question.

Also the relation between “unsafe act” during the accident and the previous convictions/accidents was investigated (figure 6). No relation was found between “unsafe act” and previous convictions. Also no difference in the number of previous accidents was found based on the presence of an ‘unsafe act’ or lack thereof. This is not in agreement with the study into mopeds and mofas [1], in which such a difference was found.

Alcohol consumption was not significantly different and rather low (3-4%) for the accident and control group. This seems to differ from the whole MAIDS population (all PTW's) in which 4% of the accident riders used alcohol and only 1.5% of the control group. Drugs use was only found in the control group for the Dutch MC riders (2%). This differs from all MAIDS data in which 0.5% of the accident and 0.2% of the control group riders were found to have used drugs. It has to be mentioned that the alcohol/drugs MAIDS analysis refers to the whole PTW group (motorcycle and moped riders).

Causation Factors

The accident cause or causes are coded by the investigator and are based upon expert opinion. The cause(s) are coded in the contributing factors section of the methodology. Three levels of certainty can be distinguished for the contributing factors: 95%, 80% and less than 80% confidence. In the analysis, only the primary contributing factor and the 95% certainty-level factors are taken into account. They are analyzed together.

The accident sample is split up into single accidents and accidents with two or more parties involved. The analysis is described below.

Single Accidents

table 4 shows the different primary factors for the 9 single accidents. Motorcycle rider comprehension failure and decision failure are the most frequent.

In almost all cases (n=7) a MC rider's unsafe act or risk taking behavior also were a main contributing factor. The possible relation between "unsafe act/risk" and violation of the traffic controls or the road speed limit was investigated and no relation was found. Analysis of the MC rider's action just before the accident showed that in 45% (n=4) no action was taken and in 45%, the action failed due to loss of control or poor execution.

Accidents with Other Involved Vehicles

In figure 7 the primary accident factors are depicted for accidents with an OV involved. It can be seen that the failure of the OV driver to observe the MC is the most frequent primary factor (34%). The second most frequent code is the MC rider decision failure (13%) and other MC rider and OV driver related factors (reaction/perception failure,

	Frequency	Percent	Valid Percent	Cumulative Percent
Valid motorcycle rider comprehension failure	3	33.3	33.3	33.3
motorcycle rider decision failure	3	33.3	33.3	66.7
roadway design defect	1	11.1	11.1	77.8
roadway maintenance defect	1	11.1	11.1	88.9
other	1	11.1	11.1	100.0
Total	9	100.0	100.0	

Tab. 4: Primary factors of single MC accident

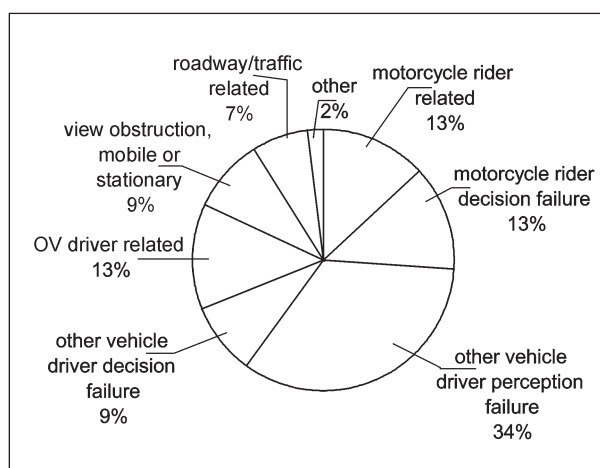

Fig. 7: Primary accident factors in non-single motorcycle accidents

etc.) which are both 13%. OV driver decision failure (9%) and view obstruction (9%) follow next.

The most frequent other contributing factors (i.e. besides the primary cause) are the MC rider's unsafe act or risk taking behavior (40%), the OV driver's unsafe act or risk taking behavior (23%) and the OV driver perception failure (9%). The factor "MC rider's unsafe act/risk" was mostly combined with the primary factors "OV driver perception failure" (33%) and "MC rider decision failure" (24%). The factor "OV driver's unsafe act/risk" was combined more frequent with the primary factors "OV driver perception failure" (25%) and "OV driver decision failure" (25%) and the other contributing factor "OV driver perception failure" with the "motorcycle rider decision failure" (40%) and "view obstruction" (40%).

The possible over-representation of MC rider's/OV driver's unsafe act with respect to the violation of the traffic control/road speed limit was investigated in this case too. No over-representation was found for both MC rider's and OV driver's unsafe act, either with the violation of the traffic control or with the violation of the road speed limit. These aspects

were equally present in accidents with and without an unsafe act as contributing factor.

Looking at the action taken by the motorcyclist to avoid the accident, the available time was not enough to complete his action in 40% of the cases, in 35% of the cases the MC rider lost control during his action and in 16% no action was taken. On the other hand, the OV driver did not react in 66% of the cases (70% in the MAIDS report), he had not enough time for his action in 18% (21% in the MAIDS report) and he made the wrong choice for an evasive action in 7% of the accidents (3% in the MAIDS report).

Loss of Control

Because of the high frequency of the MC loss of control in single and non-single accidents, the parameter was analyzed more in detail. It was found that 43% of loss of control is related to braking slide-out, which means that one of the wheels (or both) blocked during the brake actuation, resulting in a motorcycle/rider fall. From the accident group, only 2% of the motorcycles were equipped with an anti-block brake system. In the control group, the percentage was 6%. In the final MAIDS report, ABS is reported in 0,6% of the accidents and in 2,9% of the exposure population (the whole PTW population).

In the group of single accidents, two of the three cases with loss of control, had an insufficient front

tyre inflation pressure, while in other situations this under-inflation is not predominantly present. The number of cases is very small, but the same findings were found in a study into motorcycle accidents on motorways [5]. In accidents with other vehicle presence, front tyre under-inflation is not found.

Injury Analysis

The medical information, which was reported in the paramedics file or the hospital dossier, was collected by a DART member after having the written consent of the victim. The injuries were coded according to the AIS scale, version 1998.

Almost 11% of the cases were fatal accidents. In 71% of these cases, an OV was involved. The percentage of fatalities coincides with this of the whole MAIDS population in the final report. From the 921 MC riders, 100 died due to the accident (10.9%). Another aspect that was investigated is the relation between loss of control before the impact and number of deaths. It appeared that 23% of the riders who lost control ($n = 22$) died due to the accident. This group was over-represented ($ar = 2.2$, $n = 5$) compared to riders that did not lose control.

In table 5, the distribution of the injuries of different severity across the body regions is shown. Note that no AIS5 were found in the Dutch accidents,

			AIS Level					Total
			1.00	2.00	3.00	4.00	6.00	
Body Region	Head	Count	1	19	9	3	0	32
		a.r.	-5.1	2.7	3.0	2.1	-0.8	
	Face	Count	17	6	0	0	0	23
		a.r.	2.9	-1.2	-1.8	-0.9	-0.6	
	Neck	Count	1	1	0	0	0	2
		a.r.	.1	.4	-0.5	-0.3	-0.2	
	Thorax	Count	10	8	6	4	1	29
		a.r.	-1.3	-1.2	1.6	3.5	.9	
	Abdomen	Count	3	4	3	1	0	11
		a.r.	-1.2	-1	1.6	1.1	-0.4	
	Spine	Count	4	8	0	0	3	15
		a.r.	-1.5	1.3	-1.5	-0.7	5.9	
	Upper Extremity	Count	30	29	2	0	0	61
		a.r.	.7	1.8	-2.4	-1.6	-1.1	
	Lower Extremity	Count	49	21	10	0	0	80
		a.r.	3.4	-2.6	.2	-2.0	-1.4	
Total		Count	115	96	30	8	4	253

Tab. 5: Injury severity vs. body code

which is due to pure chance. The comparison with the final MAIDS report shows that the results match for the regions “head (face)” and “upper and lower extremities”. The injuries for the thorax, spine and abdomen appear to be of a higher severity in the Dutch analysis. It has to be mentioned that the final MAIDS report refers to the entire PTW population. The injuries, which were significantly over-represented in the Dutch analysis with respect to the total injury group, are shown in dark grey in table 5. Under-represented injuries are shown in light grey.

It was further looked at the body region/injury severity versus the contact partner (e.g.: car, pavement). 48% of the injuries were caused by an impact with the environment or an object (mainly the pavement), 19% by the side and 13% by the front of a vehicle. The environment/object was also the cause of most of the injuries on head (47%), thorax (33%), spine (44%), lower (54%) and upper extremities (59%). The side of a vehicle caused the most abdominal injuries (16%).

The severity is depicted in table 6. Over-represented factors are shown in dark grey, and under-represented factors in light grey.

The relation between MC impact speed and injury severity was investigated too. The MC impact

speed is defined as the speed of the MC just before the impact. The OV speed was not taken into account yet in this study. Figure 8 shows the speed versus AIS level. The impact speed is relatively high and no clear relation can be found between the speed versus AIS level. There seems to be an increase of the median speed for increasing AIS level, but this is not a significant

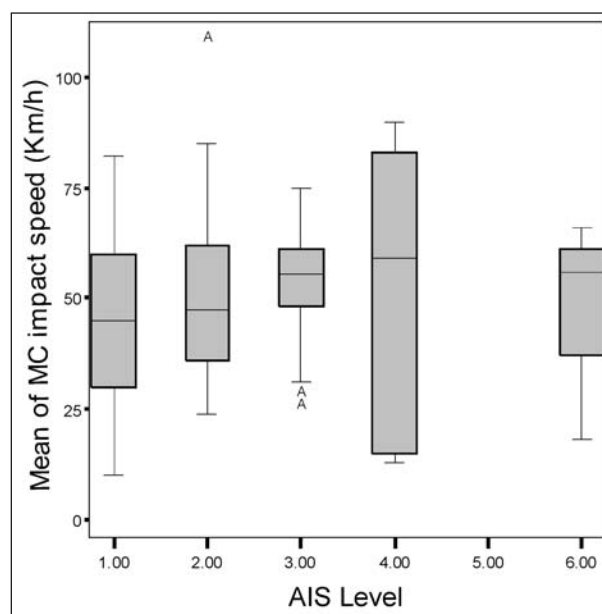

Fig. 8: AIS score vs. the mean of the MC impact speed

Contact code		AIS Level					Total	
		1.00	2.00	3.00	4.00	6.00		
Indirect	Count	1	0	0	0	0	1	
	a.r.	1.1	-8	-4	-2	-1		
Unknown	Count	0	1	0	0	0	1	
	a.r.	-9	1.3	-4	-2	-1		
Environment	Count	3	4	0	0	0	7	
	a.r.	-1	1.1	-1.0	-5	-3		
OV front	Count	72	35	13	1	1	122	
	a.r.	4.2	-2.9	-6	-2.1	-9		
Own motor	Count	10	15	6	1	2	34	
	a.r.	-2.0	.8	1.1	-.1	2.2		
OV rear	Count	11	7	2	0	0	20	
	a.r.	.9	-3	-3	-8	-6		
OV side	Count	0	4	0	0	0	4	
	a.r.	-1.8	2.6	-7	-4	-3		
OV top	Count	10	24	8	6	1	49	
	a.r.	-3.9	1.8	1.1	4.0	.3		
OV bottom	Count	5	3	1	0	0	9	
	a.r.	.6	-3	-.1	-6	-4		
Total	Count	3	3	0	0	0	6	
	a.r.	.2	.6	-.9	-.4	-.3		
Total		Count	115	96	30	8	4	253

Tab. 6: Injury severity vs. contact code

effect. The number of AIS4+ injuries is probably too limited to find a trend.

Accident and exposure groups were compared in order to identify differences in the representation of the use of motorcycle garment. The garment was split up into four categories: upper torso and upper extremities, lower torso and lower extremities, footwear and hand protection. The accident group was over-represented with respect to the control group (ar = 2.0, n = 51) for use of motorcycle oriented equipment of the upper torso. For the other three categories, no significant differences were identified.

The effect of the MC-oriented garment on the severity of the injuries produced to the area covered by the garment was investigated too. The analysis showed no significant over- or under-representation of any of the four cloth categories with respect to the severity of the injuries.

Passengers were not frequently involved in accidents and therefore no injury analysis was performed. From the 66 cases, only three riders were accompanied by a passenger. In all three cases, no interaction took place between them during the crash events.

Discussion

Due to the limited amount of cases the results are not always statistically significant. However, trends and important aspects can be clearly indicated.

Accident Type

The majority of the Dutch motorcycle accidents were accidents in which another vehicle was involved (86%). The accident percentage of OV-accidents almost coincides with the one of the whole MAIDS study. The vast majority of impact partners was a passenger car (all masses: 68.4%), which is most likely caused due to exposure. The configuration "OV performing some sort of turn in front of MC" (in general) is the most common accident type with another vehicle involved (41%). Another important configuration is driving perpendicular to the motorcycle direction by the OV (15%). Small cars (mass <800kg) are significantly over-represented in accidents where the MC rider fell trying to avoid an impact with the car. The reason for this is unclear at the moment. Heavy traffic vehicles were over-represented in

accidents where the OV turned in front of the MC, and their paths were perpendicular to each other.

Human Factors

It was found that the average age of the accident rider population is significantly lower than the control group age (95% confidence). This means that, at first view, younger riders have a significantly higher chance to be involved in an accident. Also the number of days driven per year differed significantly. These differences were so pronounced that further investigation into this area were required. A major difference was found in the months in which the accident and control data were collected. As can be seen in figure 9 the accidents were collected in different months than the control cases. This is significantly different, and should be taken into account. For this purpose it was investigated whether the control group riders are mainly seasonal riders, and the accident cases are not. It was found that in the accident case population the daily use of the particular road is over-represented (a.r. = 2.1, n=31) with respect to the control group, and in the control group more weekly use of the particular road is found (a.r. = 2.0, n=18). So this factor seems to confirm this hypothesis. Also the type of use (recreational vs. work) has a tendency in this direction. The case population seems to use the motorcycle somewhat more for work, and the control group more for recreation. This difference is however not significant.

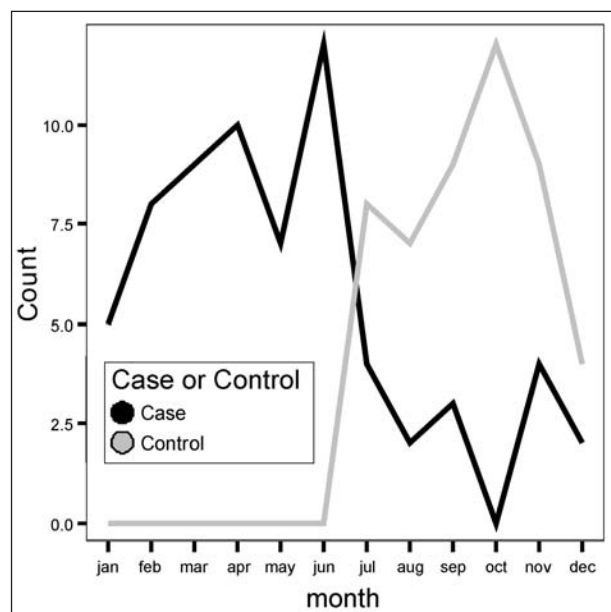

Fig. 9: Number of accidents and controls collected per month

When the number of days driven and the collection month were inserted into a logistic regression model for the prediction of case or control group (see figure 9), it was found that the number of days driven per year was not anymore a significant factor. This was also the same for the age difference between the accident population and the control group. It is therefore concluded that the difference in the number of days driven per year and the age between the accident and control group population is an artefact of the time of collection of the cases and the controls. Another explanatory factor may be that the control group sampling caused a bias towards recreational use, simply because recreational riders might have a tendency to co-operate better with a control study (that took 20 minutes of their time at the petrol station).

The investigation of previous violations on record shows a significantly higher accident involvement of riders with two or more convictions in the last five years, when the effects of age and number of days driven per year were taken into account. This indicates that the number of convictions could predict the chance to be involved in an accident. These conclusions can only be drawn with more certainty if further research into this specific topic confirms this. The numbers for alcohol consumption and drug use are too low to attach any conclusions to.

Causation Factors

Rider's comprehension and decision failure are the dominating primary factors in single MC accidents (67%). An OV driver failure (perception, decision or another failure) is by far the most common primary causation factor in accidents with OV involvement (52%). The OV perception failure is the most prominent of this failure (accounting for 34% of all accidents, i.e. 65% of all failures). Motorcycle rider related factors (e.g.: decision, reaction failure) are also very frequent (26%). In total, in 82% of the accidents any human failure was the primary cause of the accident.

A other contributing factor besides the primary cause, which appears to a high percentage in both single and non-single accidents, is the MC rider's unsafe act/risk taking behavior in the first place (40%) and the OV driver's unsafe act/risk in the second place (23%). Violation of the traffic controls and violation of the road speed limit were not

related to the unsafe act of both MC rider and OV driver. The MC riders seem to be more alert in general than the OV drivers before the impact, because they attempted an evasive action in 75% of the cases, as opposed to the OV drivers, who reacted in only 25% of the cases. In 66%, the OV drivers did not attempt an evasive manoeuvre as opposed to 16% of the MC riders. Despite the fact that the motorcyclists relatively often tried to avoid the accident, their action was apparently not successful due to loss of the motorcycle control in 43% of those cases where an evasive manoeuvre was attempted. In particular, they locked a wheel of their vehicle and slid on the pavement. In 45% of the cases where an evasive manoeuvre was attempted the action was not successful simply because there was not enough time left.

Although the frequency of ABS in the accident case group (2%, only one case) was lower than in the control group (6%, 3 cases) this is not a significant difference (a.r. is only 1.3 and the number of cases is too small as well). Although the tendency is in the direction of the conclusion that ABS increases MC safety this should be checked for a larger group of accidents (e.g. in the MAIDS study).

Injury Analysis

The percentage of fatalities is almost the same as the percentage in the whole MAIDS study (11%). An OV was present in 71% of the fatal cases, whereas in 86% of all cases an OV was involved. This seems to indicate that single MC accidents are more severe than accidents in which an OV was involved. This can however not statistically be proven; however, there is a slight tendency towards this direction. The slightly higher level of injuries in single accidents can be supported by the higher number of riders that lost control of the motorcycle in the avoidance manoeuvre. It was also found that motorcyclists who lost control have a higher probability to die in an accident.

Injuries on the lower (32%) and upper extremities (24%) and the head and face (22%) were the most frequent. The extremity and facial injuries tend to be less severe: AIS1 and AIS2 only. Head injuries seem to be more severe: AIS2 to 4 injuries to the head are significantly over-represented. Also more severe injuries were observed to be higher for the spine and thorax (AIS4 to AIS6). The environment or an object (e.g.: pavement, poles) was the most

common injury causation on head, thorax, spine, lower and upper extremities. The injuries caused by the environment and objects are typically low severity injuries: AIS1 was significantly over-represented, a.r. of 4.2, whereas the more severe injuries are under-represented. The side and front of an OV showed a tendency to produce more severe injuries: the AIS1 injuries are under-represented whereas the heavier injuries (AIS4+) are over-represented.

Concerning the speed of the motorcycle and its influence on the severity of the injuries, no significant relation could be found, although a slight increase of the median of the impact speed can be observed with higher injury severities. This might indicate that the injuries are more related to the accident configuration. This could be explained by the vulnerability of the MC rider.

Conclusions

1. In 86% of the accidents, another party is involved in MC accidents. In almost 70% of these cases the OV is a passenger car.
2. "OV turning in front of MC" (in general) is the most common accident type with another vehicle involved (41%). This might be combined with OV driver perception failure which is the most frequent primary accident factor in MC-OV accidents (34%).
3. An important result is that human failure is in 82% of the cases the main cause of the accident, in 50% this failure is due to the OV driver.
4. MC riders with two or more convictions tend to be more often involved in accidents.
5. Motorcycle riders attempted an evasive action in 75% of the cases, opposed to other vehicle drivers, who reacted in only 25% of the cases.
6. Mechanical factors hardly play any role in MC accident causation. The only factor that could play a role is front tyre under-inflation.
7. Fatal MC accidents due to loss of control are significantly over-represented.
8. Less severe injuries to lower and upper extremities are the most present for MC accidents. Head injuries are the most dangerous for MC riders, because they still appear quite often and they are typically rather severe.
9. Most injuries are caused by the environment but they are typically less severe (AIS1). Injuries caused by the car (front and side) are typically severe injuries (AIS4+).

The most important possibility for preventing MC accidents is to reduce the number of human errors, especially at the OV driver. With respect to injury prevention it is especially worthwhile improving the rider protection in motorcycle to passenger car accidents, because the contact with the car as other vehicle accounts for many and relatively severe injuries (as opposed to the environment).

Acknowledgements

The authors would like to express their appreciation to ACEM, the EU, the DART personnel, the four MAIDS partners, the police authorities, the hospital personnel and of course to the riders that co-operated with an interview for their co-operation and contribution to the realization of this study.

References

- 1 VRIES, Y. W. R. de, MARGARITIS D., MOOI, H. G.: Moped and Mofa Accidents in The Netherlands from 1999-2001: Accident and Injury Causation, Paper no. 348, ESV Conference, Nagoya, Japan, 2003
- 2 MOOI, H. G., GALLIANO F.: Dutch In-Depth Accident Investigation: First Experiences and Analysis Results for Motorcycle and Mopeds, Paper no. 236, ESV Conference, Amsterdam, The Netherlands, 2001
- 3 SPSS Inc: SPSS application guide, Chicago, IL, USA, 1999
- 4 ACEM: In-Depth Investigations of Accidents Involving Powered Two Wheelers: Final Report 1.1, Brussels, July 2004.
- 5 MOOI, H. G., VRIES, Y. W. R. de and Philippens, M. M. G. M.: Motorcycle Accidents on Highways – Analysis of In-Depth and Police Record Data (in Dutch), internal TNO report 02.OR.BV.018.1/ HGM, 2002

Poster Session

M. Hollingworth, Y. Page, M. Stanzel

B. Fildes, A. Linder, A. Clark, D. Otte, H. C. Gabler, J. K. Yang, R. Frederikkson,
Y. Fuyita, D. Cessari, K. Yang, L. Sparke, S. Smith

P. A. Brühwiler, R. Stämpfli, R. Huber, M. Camenzind

G. Schroeder, U. Bosch

S. Hauck, R. Beisse, V. Bühren

S. Majumder, A. Roychowdhury, S. Pal

J. Monclus

P. Thomas, A. Morris, G. Yannis, P. Lejeune, P. Wesemann, G. Vallet, W. Vanlaar

M. Hollingworth
Association des Constructeurs Européens
d'Automobiles, Belgium

Y. Page
Laboratoire d'Accidentologie, de Biomécanique et
d'études du comportement humain, PSA
Peugot-Citroën/Renault (LAB), France,

M. Stanzel
Volkswagen Group Research, Germany

Accident Analysis and Prevention. The E-Safety Accident Causation Analysis Group Experience

eSafety is a joint industry public sector initiative at European Union level which aims to reduce the number of casualties on European roads by encouraging the deployment of new information and communications technologies (ICT). Such technologies can be applied by drivers, the road infrastructure and the vehicles or by a combination of these and there is no doubt that they can contribute significantly to road safety even if their exact impact is not yet known. The eSafety Forum was established by the European Commission DG Information Society in 2003 as a joint platform involving all road safety stakeholders. The forum adopted twenty-eight recommendations towards better use of ICT for improved road safety and it became clear that the exact nature of the contribution that ICT can make to road safety could not be determined because consistent EU-wide accident causation analysis was not sufficiently available to assess this impact. The first of these recommendations sought to consolidate analyses from existing data sources for a better understanding of the causes and circumstances of road accidents and to determine the most effective countermeasures. The second recommendation called for the establishment of a common format for recording accident data to develop an information system covering all EU member states.

When working groups were established to undertake the work required by the recommendations, one of the first to be established was an Accident Causation Analysis working group. The overall job of this working group is to establish the requirements for the results of the recommendations to be made available. The group intends to identify the

remaining needs for a diagnosis of the safety issues and for an evaluation of the expected and observed effectiveness of the countermeasures.

Although neither in the EU nor in any of the member states there is anything like the major NHTSA accident database systems, i.e. NASS and FARS, Europe does not start from scratch in this area of course. A number of data sources already exists but they fulfil varied objectives, are often at different levels, use different methodologies, are inconsistent and do not provide a "European" analysis of accident causation. On the other hand, the EU is now funding an important project, SafetyNet, which particularly aims at making consistent accident data collection protocols in several EU countries and at constituting an accident databank on injury and fatal accidents. But the project has just started and will provide neither accident data, nor accident analysis in the short term. Moreover this project does not aim at identifying relevant methodologies to evaluate the effectiveness and efficiency of safety systems based on technology. To try to overcome these problems in the short term the working group has so far examined available data sources which are known to them. These sources are sometimes at EU level, sometimes member state level, sometimes company specific or compiled by road safety institutions. Occasionally the sources cover a number of member states. Some sources are high-level statistics while others are in-depth studies of small numbers of accidents. All these sources contain useful data, so one of the first tasks of the working group has been to see how these varied sources could be better used to yield a more consistent European picture that would provide a safety diagnosis enabling the assessment of impact and thereby identify priorities for action.

The working group has collected information about a sample of twelve databases that already exist in Europe or will be existing soon, such as CARE, MAIDS, GIDAS, EACS, CCIS, OTS, IRTAD, etc. Data exist outside Europe too of course but this has not been included since it is not always completely relevant for European experience. Some of these data sources are either private or commercial with significant access restrictions brought about by intellectual property right issues. Since there is little prospect of overcoming these restrictions there is no prospect of making disaggregated data publicly available. To overcome these problems the working group undertook some

qualitative analysis of the data sources. This analysis assessed the essential characteristics of the data and secondly the potential for the different sources to be used in conjunction with each other. Four criteria were used for this assessment:

- a) the degree of qualitative description of accidents in the data source; content, reliability, size/scope and relevance;
- b) the degree to which the source contains a statistical representativeness: content, size/scope, sub-samples, reliability and relevance;
- c) an evaluation of the sources;
- d) whether or not the source contained case studies.

The analysis confirmed the hypothesis of the working group that although many information sources already exist they are not enough as they currently exist to provide Europe with the analysis it needs because the picture obtained was a mixed one. Some data sources were never designed for the purpose of coordinated analysis and therefore have little potential. Some others have their main focus on passive safety, biomechanics or traumatology and do not give much insight into the causes of the accidents they contain. Others have considerable potential.

Based on this qualitative analysis of existing sources the working group recommended to the eSafety Forum that existing sources can help to give a better understanding on accident causation and to evaluate (at least partially) the effectiveness of some on-board safety functions, if shared analysis mechanisms are employed to interrogate the different data sources and share the results. This of course requires the formulation of a set of appropriate questions to establish what the analytical focus should be on and which can be used in the interrogation. To devise this list of questions a multi-stakeholder workshop was organised where participants shared and agreed on items in a list of questions. Since the list was long and that resources to carry out the shared analysis were limited, the list will be reordered by priority.

The next stage of the task requires the identification of gaps and lacks that need to be filled to answer the needs expressed at the workshop (and elsewhere). These gaps might

be lack of data, improvements in data analysis, etc.

So far the work on this task has been done on a voluntary basis by a group of volunteers. The next stages of the task are considerable and can only be done when resources are available to support the work. The necessary resources are expected to be made available at the end of 2004 and the work carried out over the next one and a half to two years.

B. Fildes, A. Linder, A. Clark
MUARC, Melbourne, Australia

D. Otte
Hannover Medical School, Germany

H. C. Gabler
Rowan University, New Jersey, USA

J. K. Yang
Chalmers University, Gothenburg, Sweden

R. Fredriksson
Autoliv, Sweden

Y. Fujita
Toyota, Japan

D. Cessari
INRETS, Lyon, France

K. Yang
Wayne State University, Detroit, USA

L. Sparke, S. Smith
Holden, Melbourne, Australia

Pedestrian Safety: International Collaborative Research Based on Real World Crash Data

Introduction

Pedestrian casualties are relatively common and severe types of road crashes. The number of pedestrian deaths in 14-EU countries in 1996 was reported to be 16% overall but with some individual country rates as high as 28% (ETSC, 1999). Pedestrian crashes in Australia between 1994 and 1998 accounted for 18% of all crash-related fatalities and 12% of all serious injury casualties (FITZHARRIS & FILDES, 2002). FURTHERMORE, CRANDALI et al. (2002) reported that vehicle and pedestrian collisions are responsible for more than one-third of all traffic-related deaths and injuries worldwide.

It has long been recognised that vehicle design plays a major role in determining the injury severity of pedestrian crashes with cars (World Health Organization, 2004). EEVC (2002) argued that auto manufacturers should focus on child and adult head injury and lower leg and knee injuries as priority issues for increased pedestrian protection in vehicle design. Consequently, the EEVC WG 10 and 17 for pedestrian safety in Europe developed a component test procedure for specifying pedestrian protection levels for cars that requires

compliance with a dynamic head, knee and lower leg test (EEVC 2002). It is understood that this test will be introduced soon as a mandatory requirement in Europe. Concerns have been raised that the EEVC procedure may not be a suitable test for all pedestrian crashes and whether it is likely to provide optimal pedestrian protection (FORET-BRUNO and FAVERJON, cited in EEVC 2002).

To address some of these concerns, a collaborative research project was established at the Monash University Accident Research Centre (MUARC) involving some of the world's leading specialists in pedestrian safety and crash investigation to undertake a collaborative research program into pedestrian protection with a number of relevant objectives, including:

- the extent of real world pedestrian crashes and type of impacts with passenger cars;
- identification of suitable computer models, capable of accurately predicting pedestrian head velocity and injuries in a collision with a motor vehicle;
- modelling the most common and harmful pedestrian impacts using typical large and small cars available in Australia.

These objectives will be aimed at identifying a suitable computer model for use in improving pedestrian protection as well as judging the relevance and suitability of the component test procedure for this task. The main focus of the study will be on modelling real world pedestrian crashes and outcomes, based on local and international crash data.

Collaborating Partners

A number of partners are envisaged to undertake the research and provide advice and comment on the conduct of the research program. The Monash University Accident Research Centre undertakes and manages the research in collaboration with a number of associated partners including the Medical University of Hannover, Germany; Rowan University, New Jersey, USA; Chalmers University of Technology, Gothenburg, Sweden; INRETS, Lyon, France; Wayne State University, Detroit, USA; Holden, Australia; and Autoliv, Sweden.

Research Program

A number of research tasks are envisaged during the course of this research program.

Literature Review

A review of the published literature on pedestrian safety, vehicle design and other engineering publications was undertaken, focussing on previous findings, outstanding issues, test methods and procedures, regulations (especially EEVC proposal), and dummy and biomechanical findings. The review was intended to provide background information on the safety of pedestrians and previous attempts to improve their safety.

Data Analysis

An analysis of real world field data was undertaken to establish the extent and severity of pedestrian injuries in Australia and overseas. Data used in this analysis included mass databases of fatal crashes that occurred in Australia during the late 1990s as well as in-depth pedestrian data from the Medical University of Hannover. Analysis of these data provided comprehensive details on the types of fatal crashes and injuries sustained as well as detailed information on the range and frequency of specific crash and pedestrian interactions; adult versus child pedestrian crashes and injuries; crash severity (delta-V); detailed injury outcome by body region and injury severity; impact region on the vehicle; and impact kinematics. The harm associated with these pedestrian crashes was computed using Australian injury costs for the various crash and pedestrian impacts involved to provide a profile of priority pedestrian crashes to be addressed. These findings are to be presented at the 2004 IRCOBI conference in Graz, Austria, in September, 2004.

Computer Models

Computer models of road crashes are rapidly developing and are seen as the future way of vehicle design and possibly regulation. From the range of models available, two computer models of pedestrian impacts were chosen for evaluation in this research project.

1. The Chalmers University multi-body pedestrian models (YANG & LÖVSUND, 1997) of adults (5th percentile female, and 50th percentile male (figure 1) and 95th percentile males) and child models (3yrs, 6yrs, 9yrs and 15yrs) scaled from the 50th percentile male model;

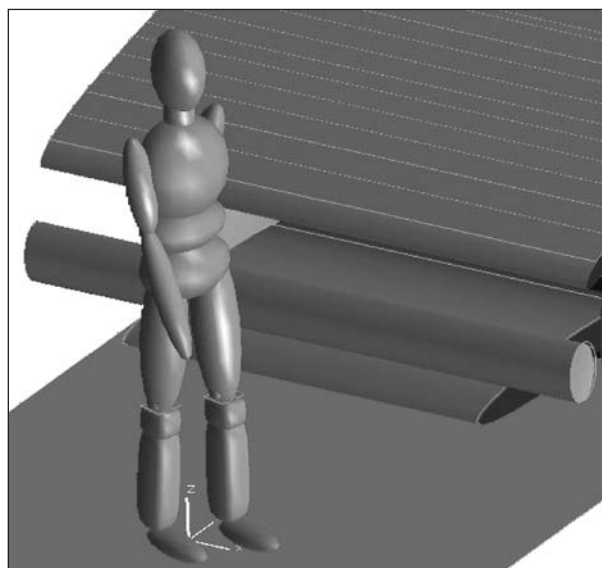

Fig. 1: Chalmers 50th percentile male pedestrian model

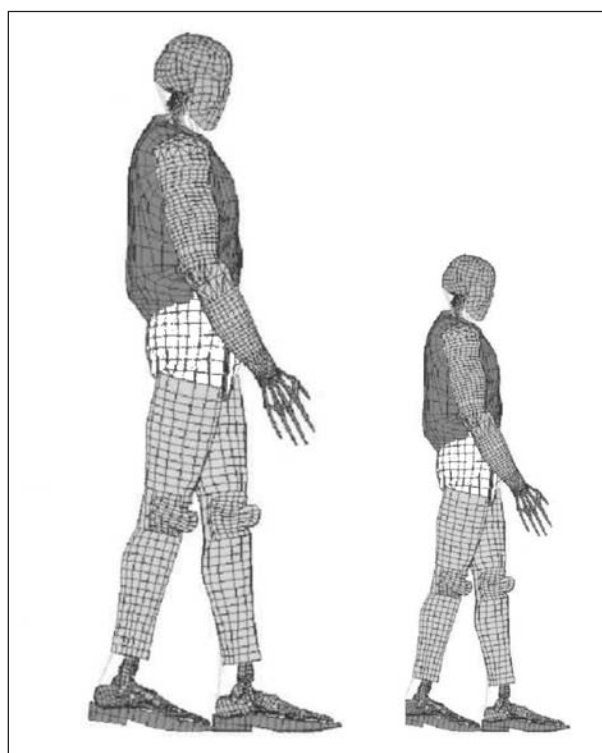

Fig. 2: THUMS-FE model of 50th percentile male pedestrian

2. The THUMS Finite Element model (IWAMOTO et al., 2003) of an adult pedestrian developed by Toyota Central R&D Labs., Inc. (TCRDL), Japan (see figure 2).

While other models are also available, the chosen models seemed to be well developed and suitable for immediate use and represented a comparison of two different types and styles of computer models.

Model Evaluation

Having chosen the two models, the next task is to compare the outcomes using a selected number of relevant in-depth pedestrian crashes. This is not intended to be an extensive validation of the models but rather a comparative study, aimed at examining the relative strengths and limitation of each model. In-depth crash data from the Medical University of Hannover will be used for this comparison task.

Optimisation Procedure

As a first step to investigate the influence of vehicle specific features on the loading to the pedestrian in the event of a crash the influence of the contour of a sedan vehicle was studied using mathematical modelling. In this pilot study an optimisation of the contour of the vehicle was obtained for four different pedestrian output measurements. The pedestrian model used for this study was the Chalmers model of a 50th percentile male pedestrian (YANG & LÖVSUND, 1997). Characteristics of the vehicle model and bonnet profiles to be used are shown in figures 3 and 4.

The procedure to be used for optimisation pedestrian impacts will rely of a number of inputs when developing and running these routines. Figures 5 and 6 show a schematic of the planned procedure. The procedure is expected to use two optimisation criteria, injury criteria and harm. Standard injury assessment functions will be used to convert model outputs into injury and harm outcomes. Particular attention will be paid to head injuries and head kinematics in this procedure.

Crash Testing

The final step in this research program will be to run a limited number of crash tests using available pedestrian dummies to evaluate the models and the model outputs, as well as to follow-up any issues that might arise throughout the research program. Tests may involve the use of available pedestrian dummies and possibly a few pedestrian cadaver tests using vehicle models and profiles established during the modelling activities.

Project Main Points

As noted earlier, the project aimed at identifying a suitable computer model for use in improving pedestrian protection as well as judging the relevance and suitability of the component test procedure for this task. A number of specific

deliverables are therefore planned to address these aims.

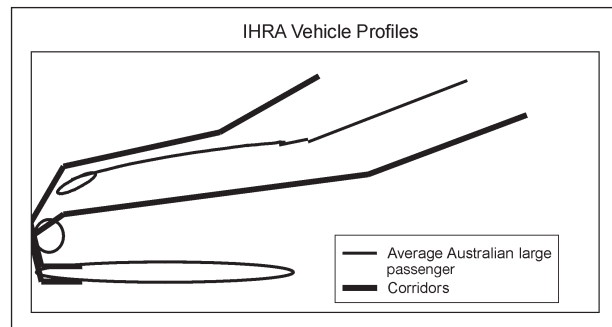

Fig. 3: IHRA vehicle front shape corridor (MIZUNO et al. 2001) and the average large Australian vehicle shape used as the baseline shape

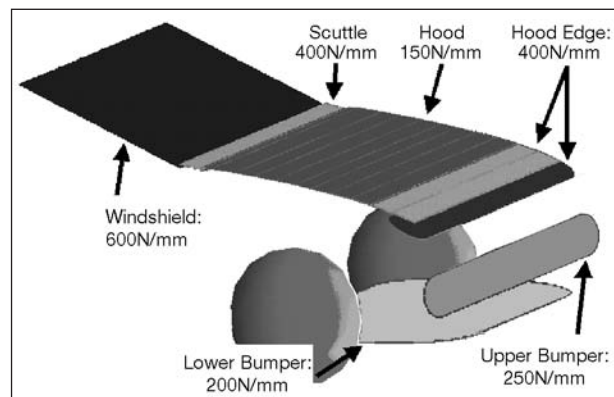

Fig. 4: Vehicle stiffness from YANG et al. (2001) and the upper and lower bumper values used for the simulations of the vehicle contour

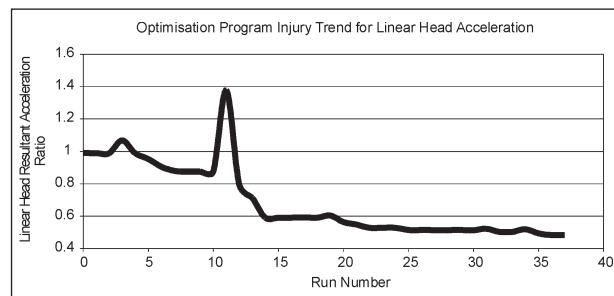

Fig. 5: Linear head acceleration

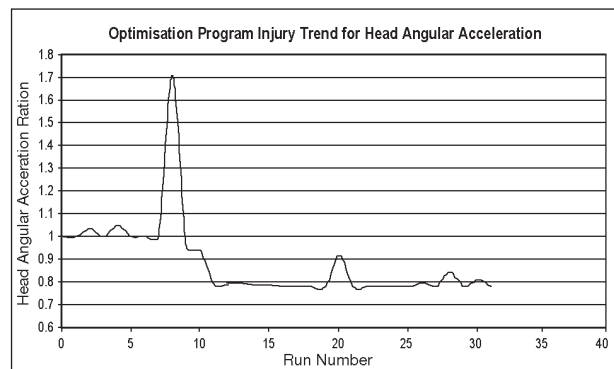

Fig. 6: Angular head acceleration

Models

One of the more important findings expected from this research program is the evaluation of the strengths and limitations of the pedestrian computer models that will be tested here and any recommendations that flow from the research as to how they might be improved or developed further for optimising pedestrian protection in crashes.

Real World Findings

The focus of this work will be on real world crashes involving child and adult pedestrians. Local and international relevant crash data will be analysed to identify priority pedestrian crashes and harm priorities. This will ensure that the research is guided by crashes that are frequent and harmful to the individuals involved. Given the various degrees of vulnerability and frailty among injured pedestrians, it is important that the research focuses on a range of different pedestrian sizes and ages as dictated by the crash findings.

Relevance of Component Test

The EEVC component test procedure essentially calls for a single crash type involving one adult and child set of injury criteria. The International Harmonisation Research Activity (IHRA) is also involved in similar research but with more of a regulation focus to what is proposed here. Findings from this program will be provided to both these bodies to help feed into their deliberations.

Reports and Papers

As noted above, it is expected that many of the findings from this research program will be published at relevant international scientific conferences throughout the course of the research. This will ensure that the results are made publicly available to vehicle designers and those with an interest in improving pedestrian safety on our roads. This could include auto manufacturers, traffic engineers and educationists from industry and governments. In addition, a final project report on the outcome of the research will be freely available to the participants as well as the general public.

Acknowledgments

The authors are grateful to Holden, Australia, for sponsorship of this research program and for their

organisations in agreeing to participate in this collaborative research activity. The views expressed are those of the authors only and do not necessarily represent those of the sponsor or its organisations.

References

- CRANDALL, J. R., BHALLA, K. S. & MADELY, J. (2002): Designing Road Vehicles for Pedestrian Protection, *Brit. Med. Journal*, 324: 1145-1148
- EEVC (2002): Improved Test Methods to Evaluate Pedestrian Protection Afforded by Passenger Cars, EEVC Working Group 17 Report, European Enhanced Vehicle-Safety Committee, Brussels, www.eevc.org
- ETSC (1999): Safety of Pedestrians and Cyclists in Urban Areas, Report, ISBN 09-76024-08-1, European Transport Safety Council, Brussels, www.etsc.be/rep.htm
- FITZHARRIS, M. & FILDES, B. N. (2002): Pedestrian Crash Injury Analysis, Occasional Report by the Monash University Accident Research Centre, Clayton, Victoria
- MIZUNO, Y. (2003): Summary of IHRA Pedestrian Safety WG Activities (2003) – Proposed Test Methods to Evaluate Pedestrian Protection Afforded by Passenger Cars. 18th International Technical Conference on the Enhanced Safety of Vehicles (ESV), Nagoya, Japan, Paper no 580
- IWAMOTO, M., OMORI, K., KIMPARA, H., NAKAHIRA, Y., TAMURA, A., WATANABE, I., MIKI, K., JASEGAWA, J., & OSHITA, F. (2003): Recent Advances in THUMS: Development of Individual Internal Organs, Brain, Small Female, and Pedestrian Model. Proc. of the 4th European LS-DYNA Users Conference, Ulm, Germany, Paper # C-1-01
- YANG, J. K. & LÖVSUND, P. (1997): Development and Validation of a Human-Body Mathematical Model for Simulation of Car-Pedestrian Impacts. Proc. of the International IRCOBI Conference on the Biomechanics of Impacts. Hannover, Germany, pp. 133-149
- World Health Organisation (2004): World Report on Road Traffic Injury Prevention, ISBN 92 4 156260 9, World Health Organisation, Geneva, www.who.int/features/2004/road_safety/en/

P. A. Brühwiler, R. Stämpfli, R. Huber,
M. Camenzind,
EMPA, St. Gallen, Switzerland

CO₂ and O₂ Concentrations in Integral Motorcycle Helmets: Cause for Alarm?

Abstract

The average CO₂ concentrations relevant to a motorcyclist wearing an integral helmet were measured twenty years ago and found to be alarmingly high. The present study examined gas concentrations typically inhaled by a motorcyclist. Average concentrations of CO₂ for persons (n=4) wearing integral motorcycle helmets were measured in the laboratory and the field to facilitate comparison to previous work, and similarly high average concentrations were found: above 2% when stationary, well below 1% for speeds of 50km/h or more. Detailed measurements of the time-dependent CO₂ concentrations during normal inhalation showed levels of about half of the corresponding average concentrations, including 1% at standstill, though higher concentrations (4% or more) are inhaled at the beginning of each breath. Opening the visor at standstill lowered the average inhaled concentration only to about 0.8%. The oxygen deficiency is equal to the CO₂ concentration, and could also contribute negatively to motorcyclist cognitive abilities.

Notation

RH relative humidity

Introduction

Motorcycle rider safety depends primarily on the cognitive faculties of the rider. A motorcycle is inherently unstable in comparison to a four-wheeled vehicle, and requires a much higher level of sustained alertness. Several studies have shown that in two-vehicle collisions involving motorcycles the other driver is found to be at fault in about 60% of the cases; commonly, other motorists overlook motorcycles and cause accidents by, e.g., turning in front of them. A motorcyclist is therefore in constant need of a high level of concentration and quick reactions, and any influence which could

reduce the cognitive abilities of a motorcyclist is therefore cause for alarm.

Helmets reduce the level of injury sustained by riders involved in accidents. On the other hand, it is not always possible to establish that helmets do not contribute to accidents. For integral helmets, e.g., which completely encase the head, the visual field could be limited, and present standards address this problem. Questions of excess heat or exhaled CO₂ [1, 2] are, however, not yet covered in motorcycle helmet standards, and may pose a hazard [3, 4]. To the extent that exhaled CO₂ is retained in a helmet, a deficit of O₂ must also be considered, and these issues are the subject of this paper.

Equipment and Methods

The measurements of the gas concentrations in the helmet dead space were conducted in the following two phases: (1) the average CO₂ concentrations were studied in subject tests in the laboratory and in the field, and compared to values obtained with a headform; (2) the detailed time-dependent CO₂ and O₂ concentrations during each breathing cycle were recorded. Phase 1 served to establish a connection between laboratory and field tests, and Phase 2 to elucidate the inhaled gas concentrations in the helmet dead space under varying conditions.

Equipment

For Phase 1, a stationary and a portable device were employed. For subject tests, a battery-

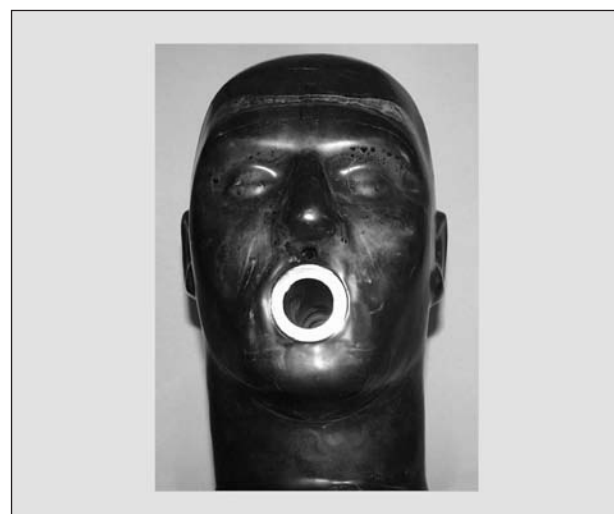

Fig. 1: Headform used to measure CO₂ concentrations. Barely discernible is a hole to which the gas detector tube was connected, between nose and mouth opening

powered infrared sensor was chosen (OEM-NDIR Gassensor Serie EGC, Pewatron AG). With the stationary system (Jaeger Oxycon Alpha, ViaSys Healthcare GmbH), both CO₂ and O₂ concentrations could be measured simultaneously. In Phase 2, therefore, the Oxycon Alpha was used to record detailed time-dependent variations in both of these gases.

Methods

The laboratory tests in Phase 1 were carried out in a climate chamber at 20°C/65% RH. The headform or subject sat at the end of a small wind tunnel; further details and an illustration of these aspects are given elsewhere [5]. For the subject tests, only CO₂ was measured, and the inlet tube was taped to the upper lip so as to place the inlet at the middle of the lip. The helmeted subjects placed their heads in the middle of the wind flow, and wore typical motorcyclist clothing. Subjects were instructed to breathe through the mouth only, and remained at rest throughout the measurements. The headform was placed so as to simulate the position of the subjects. The inlet of the measurement tube was connected to the opening in the face between the nose and upper lip. Only the exhalation portion of the breathing cycle was simulated, using an artificial lung. To ensure that both the Oxycon and NDIR values agreed, headform data were taken with both. For Phase 2,

a very short home-built mouthpiece (with virtually no additional dead space) was used, in order to measure the air entering and leaving the mouths of the subjects using the Oxycon, and nose-breathing was avoided. The O₂ concentration was measured simultaneously.

The field tests in Phase 1 were carried out during motorcycle trips by the same subjects, using the NDIR instrument and a similar measurement configuration. Breathing through the nose was permitted for these tests. The trip parameters (distance, speed, temperature, altitude, etc.) were also recorded, using a bicycle computer of model SPY 300H, SteiNamic. Motorcycle speed was equated with wind speed when comparing to laboratory measurements. Further details on the experiments are given elsewhere [4].

Results and Discussion

Average CO₂ Concentrations

A typical average headform result for the CO₂ concentration in one helmet is compared with a measurement using (n=4) human subjects in figure 2. The subject studies in the laboratory and field conditions yielded similar results, although the speeds used were not identical: “City traffic” was 36km/h (50km/h) and “Highway” was 62km/h (80km/h) for laboratory (field) measurements. The

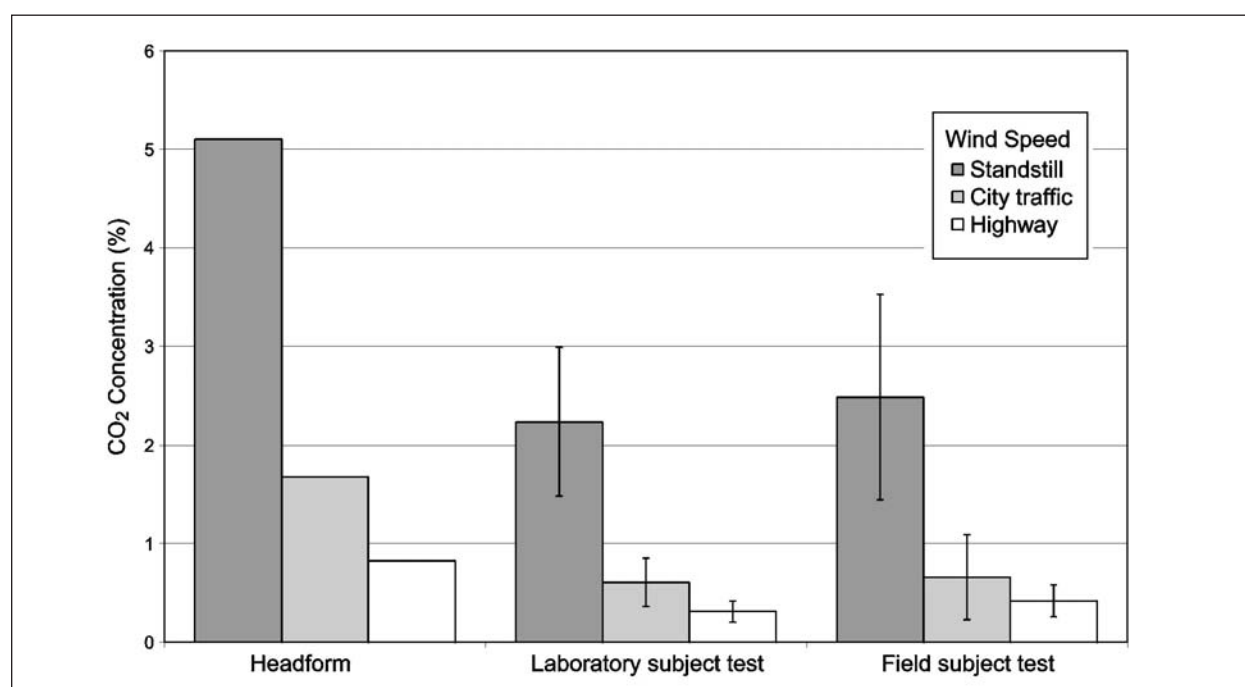

Fig. 2: Average CO₂ concentrations measured for the indicated subjects and wind speeds

good agreement shows that laboratory measurements as carried out here are directly relevant for motorcyclists in traffic. A similar variation with speed is found for all three measurement configurations, but the headform results are higher. The subject values are similar to those found by [1], though larger than those of [2], a difference previously explained as likely due to the subject clothing [2]. We tested this assumption by taking measurements without a scarf, and found that this indeed lowered the values to approach the results of [2]. One drawback of these measurements is that average values may not reflect the concentration of the gas actually inhaled by a helmet-wearer, since ventilation generally removes CO₂ and supplies O₂ before inhalation has taken place [6, 7]. The act of inhalation itself also brings fresh air into the deadspace.

Time-Dependence of the CO₂ and O₂ Concentrations

To check the effects of the helmet ventilation on the inhaled gas concentrations, the full breathing cycles of subjects in the laboratory were recorded in Phase 2. The results of one measurement are shown in detail in figure 3. In the upper figure, it is

apparent that the CO₂ and O₂ concentrations are highly complementary, down to details of the pressure fluctuations. Hence we focused on the CO₂ concentrations, equating them to the O₂ concentration decreases.

The lower part of figure 3 shows the same CO₂ measurement, but now divided into exhalation (dark) and inhalation (light) portions of each breathing cycle. We could not directly measure the direction of breathing, but because the dead space of the mouthpiece employed was so small, the start of inhalation was associated with the decrease in CO₂ concentration, and was identified using a computer algorithm. The increase in CO₂ concentration associated with exhalation was similarly identified. To account for the fact that exhalation begins with the expulsion of gas from the body's dead space, which has the same concentration as was inhaled immediately prior, we chose an arbitrary offset of 0.3s before the concentration increase as shown, which appears to be reasonable from the data in figure 3 and other data, and is consistent with similar measurements done elsewhere [6]. Nevertheless, this introduces an uncertainty into the evaluated inhaled gas concentrations. These were evaluated by averaging the concentration in the inhalation portion of each cycle. Since the highest concentrations are inhaled first, and since the lowest concentrations (inhaled last) are to some extent not available for gas exchange due to the body's dead space, these average concentrations are not completely comparable to concentrations steadily supplied for breathing in other tests. A better measure of the effective inhaled concentration would require much more detailed analysis of the final gas distribution and exchange in the lungs, which is beyond the scope of the present work. Because of the large initial concentrations in each inhalation, a slight upward revision of the present concentrations from the Phase 2 measurements for comparison to constant value studies is probably reasonable. Table 1

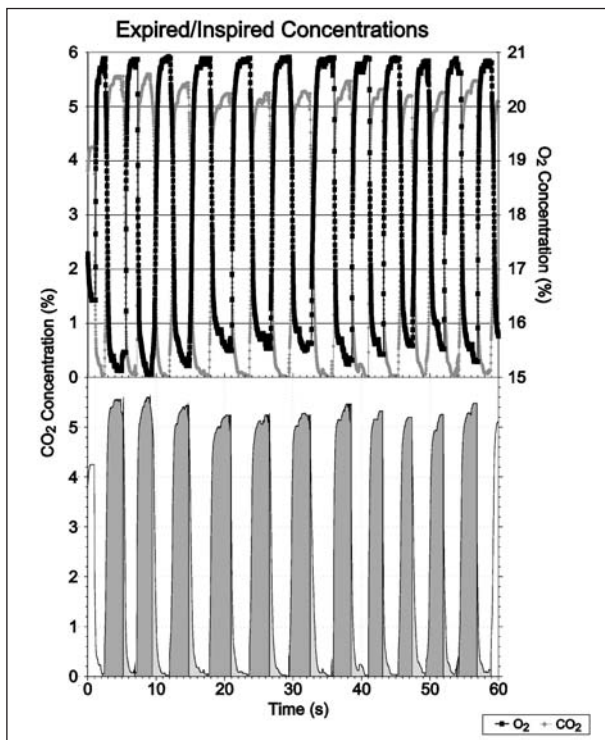

Fig. 3: Upper: Time-dependent concentrations of the indicated gases at the mouth of a subject wearing an integral helmet with visor closed and zero wind. Lower: The CO₂ concentration analyzed for exhalation and inhalation portions of the breathing cycle, as described in the text

Condition	Inhaled CO ₂ Concentration (%)	
	Mean	σ
Without helmet	0.16	0.04
With helmet, visor open	0.77	0.21
With helmet, visor closed	1.08	0.27
With helmet, visor closed, scarf, wind (50km/h)	0.27	0.19

Tab. 1: Average inhaled CO₂ concentrations under the indicated test conditions for one subject. Similar results were obtained with other subjects

shows the present results for one subject, for which a series of breathing cycles were evaluated.

The results shown in table 1 are qualitatively consistent with those given in figure 2 and elsewhere [1, 2], but much lower. Putting a helmet on and keeping the visor open leads to inhaled CO₂ concentrations which slightly exceed the norm limits for workers exposed over periods of hours (0.5% in several countries). Closing the visor tends to raise the concentration even further. When moving at reasonable speed, however (visor closed), the concentration falls back towards the values for normal breathing. This matches with the experiences of many riders wearing integral helmets, who rarely experience breathing discomfort except when standing still. Thus, previous suggestions [2, 1] of values much higher than 1% are not supported by the present analysis. The complementary lowering of the oxygen concentration in the helmet dead space is therefore also at most about 1% (to about 20%) during inhalation, a level which lies well above the values at which strong physiological effects have been observed.

Typically, the maximum allowed concentration of CO₂ in workplaces is 0.5%. In addition, values of 1% are allowed for exposures of 15 minutes or less in Sweden, for example. The degree to which exposures as high as 1% or higher occur when wearing an integral helmet is unclear, since motorcyclists often raise their visors when stopped, which should bring the concentration below that level. Thus, it does not appear that the official safe levels of CO₂ are exceeded by motorcyclists. However, the effects of low concentrations of CO₂ (and lowered concentrations of O₂) on cognitive abilities relevant to the control of a motorcycle are unknown. Recent studies [8, 9] suggest that perception of motion and stereoacuity are noticeably reduced after short periods of exposure to 2.5% CO₂, and as reviewed elsewhere [4], other phenomena related to the good functioning of the brain are similarly sensitive on short timescales. Hence research directed specifically at the question of the physiological effects of wearing an integral helmet on the ability to control a motorcycle are required to understand whether such helmets contribute to the accident statistics.

Summary and Outlook

The present work has confirmed that both the CO₂ and O₂ concentrations deviate from the atmospheric ideal for the wearer of an integral helmet, especially at standstill, but with a maximum deviation of about 1%, i.e., to an extent below that previously reported. It remains to be established whether the short periods of exposure normally expected for a typical motorcyclist (e.g. when stopped at a traffic light) are enough to affect cognitive performance, and thereby contribute to the accident probability. In cooler weather, the drive to lift the visor when stopped can be reduced, suggesting that natural feedback mechanisms will not automatically eliminate the problem, and therefore that future work on the cognitive aspects of exposures at these levels is warranted.

References

- [1] ALDMAN, B., BALLDIN, U., GUSTAFSSON, H., NYGREN, Å., SPORRONG, A., ÅSTRAND, I.: Carbon dioxide retention inside motorcycle helmets, IRCOBI, Salon-de-Provence (France), 1981, pp. 128-137
- [2] IHO, L., JONASSON, H., PETERSSON, J.-I., STRIDH, G., LJUNG, C.: Measurement of aerodynamically generated noise and concentrations of carbon dioxide and oxygen in protective helmets for motorcycle riders, Report SP-RAPP 1980:31, Statens Provningsanstalt, Sweden, 1980
- [3] CHINN, B., CANAPLE, B., DERLER, S., DOYLE, D., OTTE, D., SCHULLER, E., WILLINGER, R.: Final report of the action COST 327: Motorcycle safety helmets, European Commission, Directorate General for Energy and Transport, Brussels, 2003, pp. 44-53
- [4] BRÜHWILER, P. A., STÄMPFLI, R., HUBER, R., CAMENZIND, M.: CO₂ and O₂ Concentrations in Integral Motorcycle Helmets (submitted)
- [5] BRÜHWILER, P. A.: Heated, Perspiring Manikin Headform for the Measurement of Headgear Ventilation Characteristics, Measurement Science and Technology, 14 (2003) 217-227
- [6] MICHEL, E. L., SHARMA, H. S., HEYER, R. E.: Carbon Dioxide Build-up Characteristics in Spacesuits, Aerospace Medicine, 40 (1969) 827-829

- [7] WARKANDER, D. E., LUNDGREN, C. E. G.: Dead Space in the Breathing Apparatus - Interaction with Ventilation, *Ergonomics*, 38 (1995) 1745-1758
- [8] SUN, M., SUN, C. N., YANG, Y.: Effect of low-concentration CO₂ on stereoacuity and energy expenditure, *Aviation Space and Environmental Medicine*, 67 (1996) 34-39
- [9] YANG, Y. D., SUN, C. N., SUN, M.: The effect of moderately increased CO₂ concentration on perception of coherent motion, *Aviation Space and Environmental Medicine*, 68 (1997) 187-191

G. Schroeder
Institute of Legal Medicine,
Hannover Medical School, Germany

U. Bosch
Center of Orthopaedic Surgery, Sports
Traumatology, International Neuroscience
Institute, Hannover, Germany

Is the Kneebag Save in Out of Position Situations?

Abstract

Nowadays airbags are part of the standard equipment in almost all new cars. While airbags are saving an increasing number of people from severe injuries and death in moderate and high speed crashes, they do not completely prevent dashboard injuries. The most common mechanism in dashboard injuries is a posteriorly directed force to the proximal tibia with the knee flexed. This may occur during a motor vehicle frontal impact accident when a knee of the driver or the front-seat passenger strikes the dashboard. The posterior force can be combined with a abducting or rotational force leading to concomitant lateral or posterolateral injury.

Car and airbag manufacturers therefore develop special inflatable systems to reduce the impact force in dashboard injuries.

Every new inflatable system, however, has to be evaluated in out of position situations in which the system might cause injuries to certain body areas.

Therefore, we investigated a new kneebag system in different critical seating positions of post mortem test subjects (PMTS).

The tested knee airbag module is a folded airbag (18 litre volume) which is installed below the lower section of the instrument panel of a passenger car. Using four PMTS (2 male, 2 female, age 36–67) the following positions were tested: normal seating position, knee flexed >90 degrees and knee flexed <60 degrees in static deployment tests with direct contact. In addition a dynamic test (48.8kph, AAMA-pulse) was carried out with the PMTS belted in a normal seating position. The inflation phase and the impact of the system on the knee/lower leg were analysed by high speed videos. After the test

the lower legs of the PMTS were examined by X-ray and autopsy. All soft tissue injuries and bone fractures were recorded.

All the tests could be evaluated. Except some superficial skin lesions in the impact area no fracture of the bones around the knee and no knee ligament and tendon injuries were observed.

Neither video analysis nor autopsy of the PMTS showed any critical contact injuries caused by the inflation process of the bag. Therefore, it can be concluded that in the tested seating positions which are the most critical for the knee area the knee bag system is safe.

Introduction

Nowadays airbags are part of the standard equipment in almost all new cars. While airbags are saving an increasing number of people from severe injuries and death in moderate and high speed crashes, they do not completely prevent dashboard injuries. The most common mechanism in dashboard injuries is a posteriorly directed force to the proximal tibia with the knee flexed. This may occur during a motor vehicle frontal impact accident when a knee of the driver or the front-seat passenger strikes the dashboard. The posterior force can be combined with a abducting or rotational force leading to concomitant lateral or posterolateral injury.

Car and airbag manufacturers therefore develop special inflatable systems to reduce the impact force in dashboard injuries.

Every new inflatable system, however, has to be evaluated in out of position situations in which the system might cause injuries to certain body areas.

Therefore, we investigated a new kneebag system in different critical seating positions of post mortem test subjects (PMTS).

Methods

The tested knee airbag module, with its folded airbag (18 litre volume), is installed below the lower section of the instrument panel in the area of the jacket tube. In the event of deployment, the airbag tears open a seam on the instrument panel and expands in the form of a bolster, which stretches from the side door covering to the dome, in front of



Fig. 1: Location of the inflated knee bag system

the knee impact area on the instrument panel. The fabric is made of Polyamide. Figure 1 shows the location of the bag after the inflation.

Using four PMTS (2 male, 2 female, age 36-67) following positions were tested: normal seating position, knee flexed >90 degrees and knee flexed <60 degrees in static deployment tests with direct contact. In addition a dynamic test (48.8kph, AAMA-pulse) was carried out with the PMTS belted in a normal seating position. The inflation phase and the impact of the system on the knee/lower leg was analysed by high speed videos. After the test the lower legs of the PMTS were examined by x-ray and autopsy. All soft tissue injuries and bone fractures were recorded.

Chosen Seating Positions

Tables 1 to 3 give an overview about the chosen seating positions.

In addition to the static test series one dynamic test was carried out. A specially prepared body-in-white was put on a sled and was driven at 48.8 kph against brake tubes to simulate the AAMA-pulse. The PMTS was belted and seated in a normal driver position (table 4).

Test Conditions and Medical Examination

The post mortem test subjects were seated in the car as seen in the tables 1 to 4. All PMTS were belted. No additional instrumentation in the lower leg area was used. Next to the test an autopsy of the lower leg area was carried out, starting with an optical examination of the hip, the knee joints, the

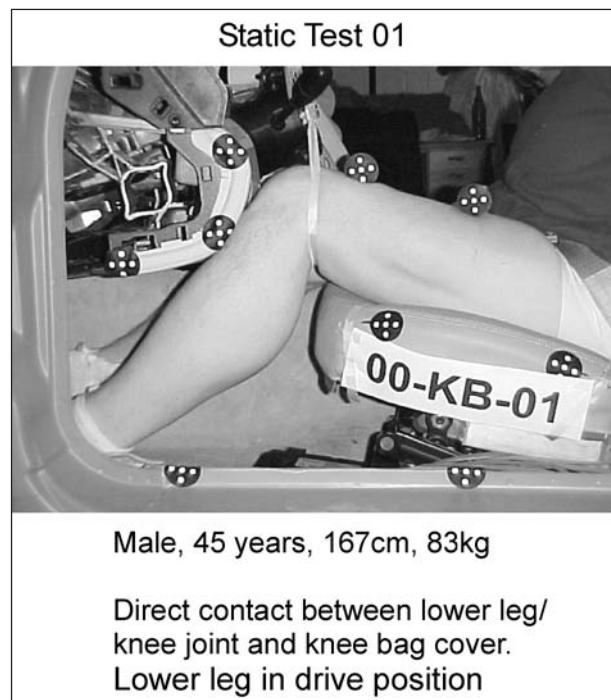

Tab. 1: Static inflation test 01

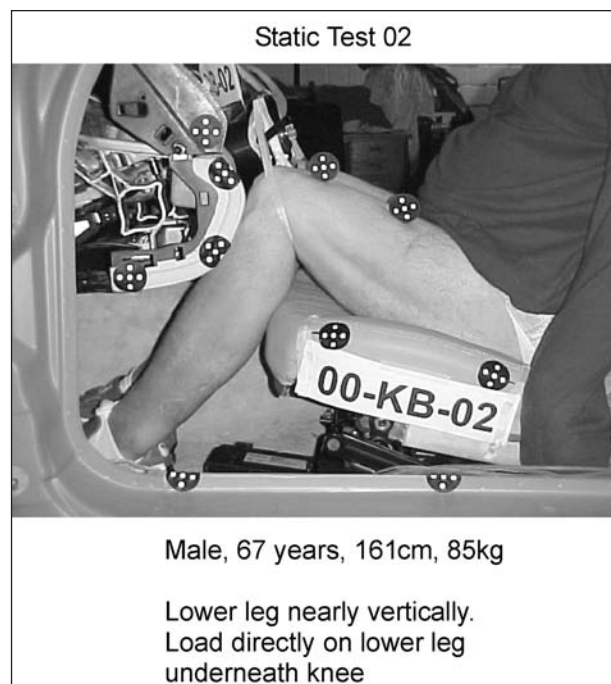

Tab. 2: Static inflation test 02

thighs and the lower legs. Beyond that X-rays of the bony structure were taken to identify possible fractures.

After that the knee area was opened to examine in detail the cruciate ligaments and the collateral ligaments. Figure 2 shows the location of the ligaments (ROHEN, 1988).

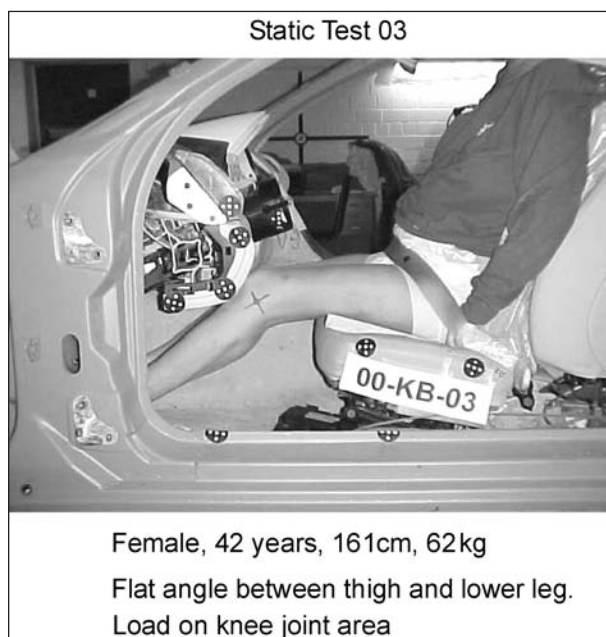

Tab. 3: Static inflation test 03

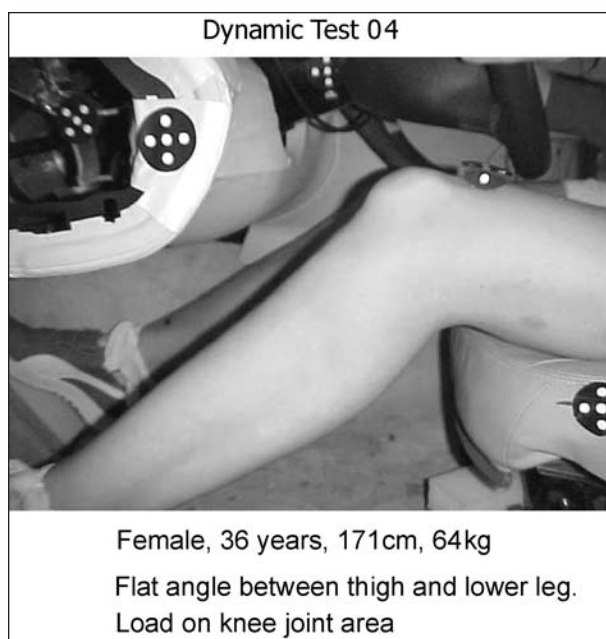

Tab. 4: Dynamic test at 48.8kp/h with inflatio



Fig. 2: Lig. cruciatum ant.
Lig. collaterale

Lig. cruciatum post.



Fig. 3: Picture of typical
superficial bruises

Example of uninjured
collateral ligament

Results

All the tests could be evaluated. Except some superficial skin lesions in the impact area no fracture of the bones around the knee and no knee ligament and tendon injuries were observed. This is shown as an example in figure 3.

Also the knee movements caused by the impacts were uncritical: in some cases a compression of the thigh could be observed without movement in the hip area. After the compression phase the knees were moved to the sides. In none tests additional injuries could be examined during the movements.

Conclusion

The goal of this investigation was focused to possibly direct contact injuries caused by the inflation process of the bag. Neither the level of injury nor the film analysis showed a potential for occupant risk. This result was confirmed by examinations of the lower extremities.

Therefore, it can be concluded that in the tested seating positions which are the most critical for the knee area no additional risk for the occupants can be derived.

References

- BURGES, DISCHINGER, O'QUINN, SCHMIDHAUSER: Lower Extremity Injuries in Drivers of Airbag-Equipped Automobiles: Clinical and Crash Reconstruction Correlations, *The Journal of Trauma*, Volume 38 (4), 1995
- ROHEN, YOKOCHI: Anatomie des Menschen. Schattauer Verlag, Stuttgart – New York, 1988

Hauck, S., Beisse, R., Bühren, V.
 BG-Unfallklinik Murnau, trauma center,
 Murnau, Germany

Severe Seat-Belt Syndrome in Children: A Case Report of two Children

Abstract

The so-called "seat-belt injuries" or "seat-belt syndromes", described as 2-point seat-belt injuries, contain heavy inflection injuries of the lumbar spinal column, combined with heavy abdominal injuries as rupture of the upper intestinal bold or heavy injuries of the upper entrails.

With "playing" children in the front of the car, with inappropriate plant of 3-point belts, identical injuries can occur.

Introduction

Since the sixties there are many publications about seat-belt syndrome or seat-belt injuries in children in the Angloamerican and German linguistic area [1, 2, 3, 4, 5, 6, 7, 8]. Mostly to the belts of point of 2, like the lap belts of the rear center, one refers (figure 1).

The injuries most described with seat-belt syndromes are L1 and L2 burst fractures, mostly AO-Type B1.2, B2.2 or B2.3 with heavy abdominal traumatic injuries like rupture of bowels, pancreas, liver or/and spleen. With the introduction of the

3-point seat-belts in the rear of the cars these heavy injuries were seen less or only by front passengers, sitting in the middle with a 2-point seat-belt fixation.

We would like to present a case of two girls, who suffered a traffic accident with inappropriate plant of 3-point belts as rear passengers, with which it had come to heavy "seat belt injuries".

Material/Method/Results

Two girls, 14 years and 11 years old, with 3-point belt system secured as rear passengers, suffered heavy abdomino-lumbale injuries by a traffic accident.

The 14 year old girl (patient 1) showed an initial GCS of 15 and stable cycle conditions, the 11 year old girl (patient 2) showed an initial GCS of 15 and unstable cycle conditions at the accident place.

After lead-in supply and rescue by means of helicopters the diagnostics in the clinic showed a L 3/4 spondylises with flexion without neurological deficit and rupture of the Jejunum (patient 1) (figure 2).

The 11 year old girl (patient 2) showed a spondylises with flexion of T 12/L 1 without neurological deficit, a rupture of the kidney on the right side, a rupture of the liver, the spleen and the diaphragm and a rib series fracture with a haematopneumothorax (figure 3).

The immediate operational supply of the abdominal injuries took place, time-delayed in each case the spinal column injury was fixed with an internal fixture (figure 4).

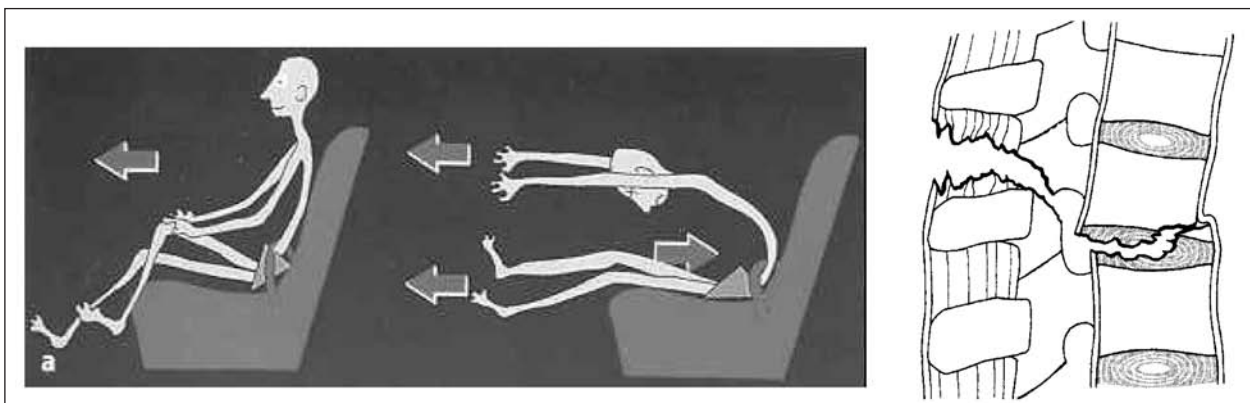

Fig. 1: Seat-belt injuries mechanism (H. TSCHERNE, M. BLAUTH et al.: Brust- und Lendenwirbelsäulenverletzung, Springer Verlag 1998, S. 257)



Fig. 2: L 3/4 fracture type B2.2, preoperative, postoperative with internal fixation

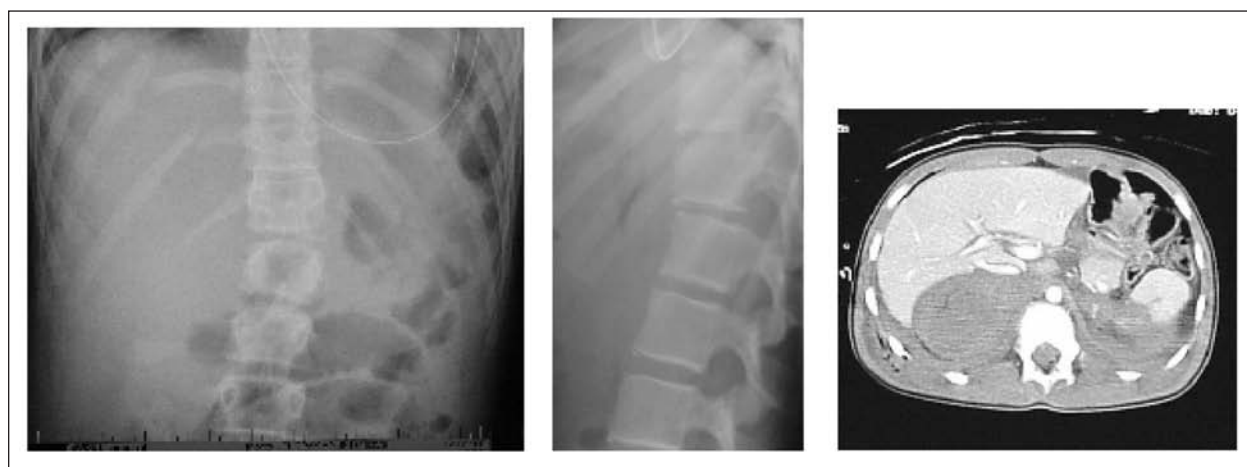

Fig. 3: T 12/L 1 fracture type B2.2, preoperative, rupture of kidney right side, liver, spleen



Fig. 4: Intraoperative view with stabilisation of the spine, exploration of the bowels

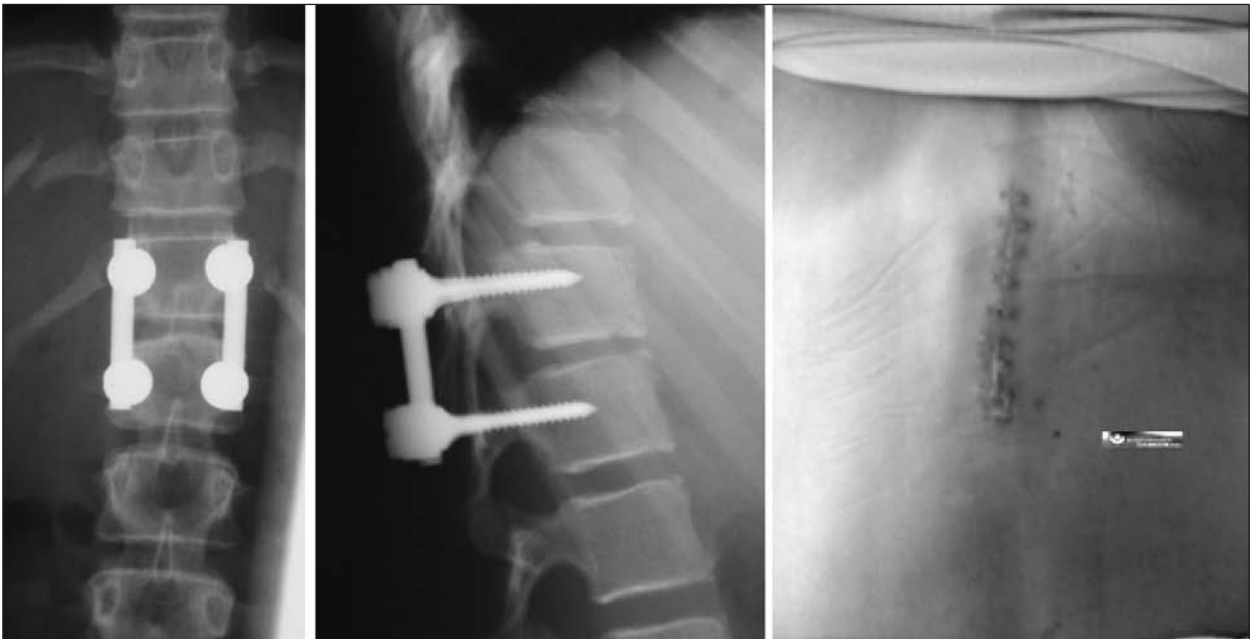

Fig. 5: Postoperative with internal fixation, clinical after 15 days



Fig. 6: Correct position of the 3-point belts, inappropriate plant of 3-point belts “playing children”

The stationary stay of both girls amounted to 20 days, of it on intensive care unit 10 days. The re-examination showed good results without consequences process, the ME of the interval fixture interne took place after 5 months, both girls showed a fully portable recover in each case with only small spinal column complaints.

Conclusion

The so called “seat-belt injuries” or “seat-belt syndromes”, described as 2-point seat-belt injuries, contain heavy inflection injuries of the lumbal spinal column, combined with heavy abdominal injuries as rupture of the upper intestinal bold or heavy injuries of the upper entrails. With “playing” children in the font of the car, with inappropriate plant of 3-point belts, identical injuries can occur.

References

1. GRIFFET, J., BASTIANI-GRIFFET, F., EL-HAYEK, T., DAGEVILLE, C., PEBEYRE, B.: Management of seat-belt syndrome in children. Gravity of 2-point seat-belt. *Eur J Pediatr Surg.* 2002 Feb; 12 (1):63-6
2. CORNELI, H. M., COOK, L. J., DEAN, J. M.: Adults and children in severe motor vehicle crashes: a matched-pairs study. *Ann Emerg Med.* 2000 Oct; 36 (4):340-5
3. LEVINE, J. L., FARIES, P. L., WEINBERG, G.: Seat-belt injury presenting as bilateral abdominal wall herniations in a child. *Pediatr Emerg Care.* 1998 Oct; 14 (5):352-3. Review
4. GUPTA, N., AUER, A., TROOP, B.: Seat-belt-related injury to the common iliac artery: case report and review of the literature. *J. Trauma.* 1998 Aug; 45 (2):419-21. Review

-
- 5 ILLUMINATI, G., CALIO, F. G., BERTAGNI, A., FORTE, A., GALLINARO, L., MONTESANO, G.: Seat-belt injuries to the supra-aortic trunks. *Eur Rev Med Pharmacol Sci.* 1997 Jul-Aug; 1 (4): 87-93
 - 6 ELTAHIR, E. M., HAMILTON, D.: Seat-belt injuries and sigmoid colon trauma. *J. Accid Emerg Med.* 1997 Sep;14 (5):338-9
 - 7 SMITH, M. D., CAMP, E., JAMES, H., KELLEY, H. G.: Pediatric seat-belt injuries. *Am Surg.* 1997 Mar; 63 (3):294-8
 - 8 HINGSTON, G. R.: Lap seat-belt injuries. *N Z Med J.* 1996 Aug 9; 109 (1027):301-2

S. Majumder, A. Roychowdhury
Dept. of Applied Mechanics, Bengal Engineering
College (Deemed University), Howrah, India

S. Pal
School Bio-science and Engineering, Jadavpur
University, Kolkata, India

A Finite Element Study on the Behavior of Human Pelvis under Impact through Car Door

Abstract

Pelvic fracture, cracking or breaking of a portion of the pelvis are extremely common injuries in the side impact collisions of motor vehicles. Due to both its shape and structural architecture, mechanics of the pelvic bone is complicated. There is a lack of knowledge regarding the dynamic behavior of the pelvis and its biomechanical tolerance under impact environment. Hence this study is aimed at the understanding of the mechanical response of the human pelvis with three-dimensional finite element (FE) models, under side impact load, applied through a structure, equivalent to a car door. The door structure was modeled, considering few layers, consisting of foam (Styrodur[®], 3035 CS), plastic (UHMWPE), steel, glass and steel, putting them in series. A soft tissue layer (equivalent to fat) was also considered on the greater trochanter location. These FE models (with and without the car door structure) were analyzed with ANSYS-LS-DYNA[®] dynamic finite element software to compare the effect of the car door padding system for shock absorption. It was observed that with proper combination of shock absorbing material (foam, etc.) and its thickness, the transmission of impact load to the body part (pelvis, etc.) from the outer surface of the car door could be reduced.

Introduction

The Pelvis is most susceptible to severe fractures in near-side motor vehicle crashes due to intrusion of door and impact loading through greater trochanter. Car manufacturers are giving more importance to the protection of the occupants in lateral impacts. With the rapid industrialization and advancement of technology, uses of high-speed cars are increasing day by day. As a result, the car

accidents are also increasing. A survey showed that side-impacts represented 15-30% of the collision [9]. Due to these accidents, the pelvis (8-14%) is the one of the most affected areas of the human system [2]. Pelvic fracture, cracking or breaking of a portion of the pelvis [14, 20] are extremely common injuries in side-impact collisions of motor vehicles. The victim of a side-impact car collision is likely to end up with a fractured pelvis, an injury that may take weeks or months to heal. Otherwise, the victim may walk away only to discover years later that he or she is suffering from post-traumatic arthritis, a long-term disability caused by undiagnosed cartilage damage. Fractures at pubic rami, acetabuli, iliac wing, pelvic ring disruption, or posterior injuries such as sacral fracture are commonly observed [8, 19].

In the musculoskeletal system, the pelvis is one of the most vital components. The lower extremities are connected to the upper portion of the body through the pelvis. The role of the pelvis is to transfer gravitational and external load across the sacro-iliac joints and the hip joints. The pelvic bone contains mainly of low-density trabecular bone that is covered by the high strength cortical bone of varying thickness in the form of a thin shell. Due to both its shape and structural architecture, the mechanics of the pelvic bone is complicated.

To establish the biomechanical response and injury tolerance, automotive side impact conditions were simulated through experimental analyses [2, 3, 7, 12, 13, 21]. Through these investigations, different fracture tolerance criteria were established, with the help of different testing protocols. In addition to experimental testing, only few investigators [5, 11, 15, 17] performed analytical simulations to address the issue of impact load tolerance of the pelvis with the help of the finite element method (FEM).

Objectives of this study were to develop a three-dimensional finite element model of the pelvis along with an equivalent car door structure and analyze them under dynamic load, resulting from motor vehicle side impact condition. Thus the present study was aimed at a better understanding of the mechanical response of the pelvis under dynamic loading through a car door and impact absorbing capability of the car door with proper padding.

Methodology

Solid modeling, finite element mesh generation, selection of material properties, imposition of boundary conditions (loads and constraints), solutions, dynamic analysis and interpretation were done with the help of the commercially available finite element modeling and dynamic analysis software ANSYS® (ANSYS, Inc. Pennsylvania, USA) and ANSYS-LS-DYNA® (LSTC Corporation, USA and ANSYS, Inc. Pennsylvania, USA).

Finite Element Modeling

The three-dimensional finite element model of the pelvis, used in this study, was a modified version of our earlier models (figure 1a–c, MAJUMDER et al. [10] and figure 1d–f, MAJUMDER et al. [11]), developed from co-ordinate data [6] of a dried pelvis cadaver. An idealized sacral bone was modeled for this study, in the form of a solid bar (figure 1d–f) whose cross-section was close to sacro-iliac articulating surface. As the side impact

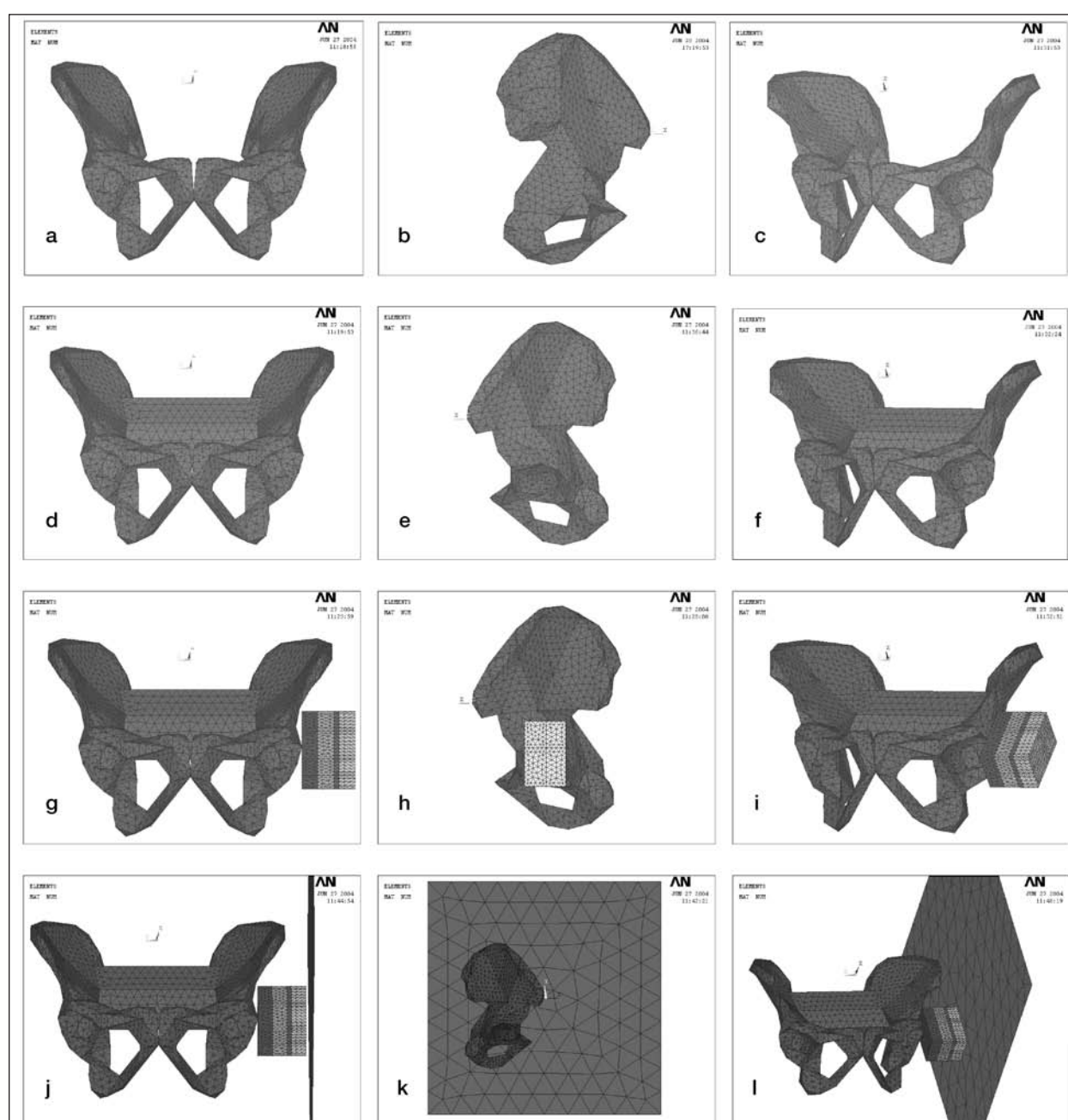

Fig. 1: Different views of the three-dimensional finite element models, (a-c): Only pelvis without sacrum, from MAJUMDER et al. [10]; (d-f): Full pelvis with idealized sacrum for this study and from MAJUMDER et al. [11]; (g-i): Full pelvis with equivalent car door structure; (j-l): Rigid wall with which full pelvis with equivalent car door structure collided

is transmitting through the car door, an equivalent car door structure attached to the left greater trochanter was modeled (figure 1g-l). This equivalent structure of a car door was simulated by considering few layers ('b', 'c', 'd', 'e' and 'f' in figure 2) consisting of foam (Styrodur[®], 3035 CS),

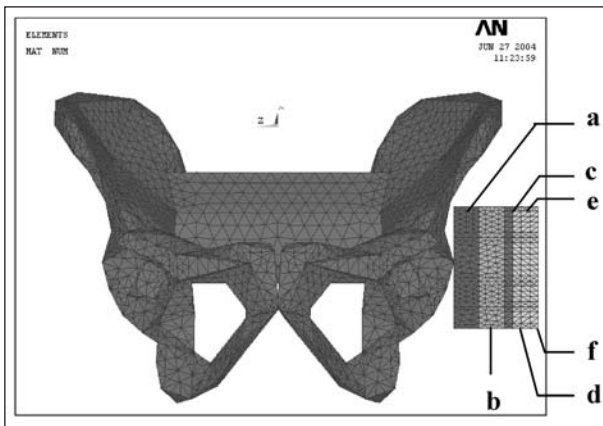

Fig. 2: Three-dimensional finite element model (22,967 tetrahedral and 5,820 shell elements through 5,824 nodes) of human pelvis with layers of soft tissue and equivalent car door structure (a – Soft tissue; b – Styrodur[®] Foam; c – Plastic (UHMWPE); d – Steel; e – Glass; f – Steel)

	E (MPa)	ρ (kg/m ³)	ν
Cortical Bone*	17,000	2,000	0.3
Trabecular Bone*	70	1,500	0.2
Soft Tissue**	20	750	0.49
Styrodur [®] Foam***	20	33	0.4
Plastic (UHMWPE)**	1,100	937	0.34
Glass	62,000	2,230	0.22
Steel	200,000	7,850	0.3

E – Young's modulus of elasticity
 ρ – Density and ν – Poisson's ratio
 * from DALSTRA and HUISKES [4]
 ** from ROYCOWDHURY [18] and
 *** from BASF Aktiengesellschaft [1]

Tab. 1: Material properties, used for FE model of the pelvic bone, soft tissue and equivalent car door structure

plastic (UHMWPE), steel, glass and steel, putting them in series (with thickness of 15, 5, 5, 5 and 5mm respectively). A soft tissue layer (equivalent to soft tissue and fat) of 15mm thickness was also considered on the greater trochanter location (layer 'a' in figure 2). Assuming the car hitting the wall on lateral impact, an equivalent rigid wall was modeled (figure 1j-l) very near (6 mm) to the pelvis (acetabulum) and car door structure.

The shell element and solid (tetrahedral) element were used to represent the cortical bone and trabecular bone of the pelvis respectively. Soft tissue (fat) and five layers of the equivalent car door structure were modeled with solid (tetrahedral) elements. The degrees of freedom (dof) for the ANSYS[®] solid and shell elements were six (three translational and three rotational) each. Similarly the dof for the ANSYS-LS-DYNA[®] solid and shell elements were nine (three translational, three velocity, three acceleration) and twelve (three translational, three rotational, three velocity, three acceleration) respectively. The pelvic FE model without the car door structure (figure 1d-f) contained 5,820 shell elements and 13,070 tetrahedral elements. Hence the total 18,890 elements were connected through the 3,704 nodes. The FE model of the car door structure contained 9,897 tetrahedral elements. Hence in case of the pelvic model with car door (figure 1g-i), the total 28,787 elements were connected through 5,824 nodes.

The material properties of the pelvic bone were assumed to be isotropic and the material distribution was assumed to be homogeneous throughout the pelvic model. The same was considered for the layers of the car door structure. All the properties required for this analysis are given in table 1.

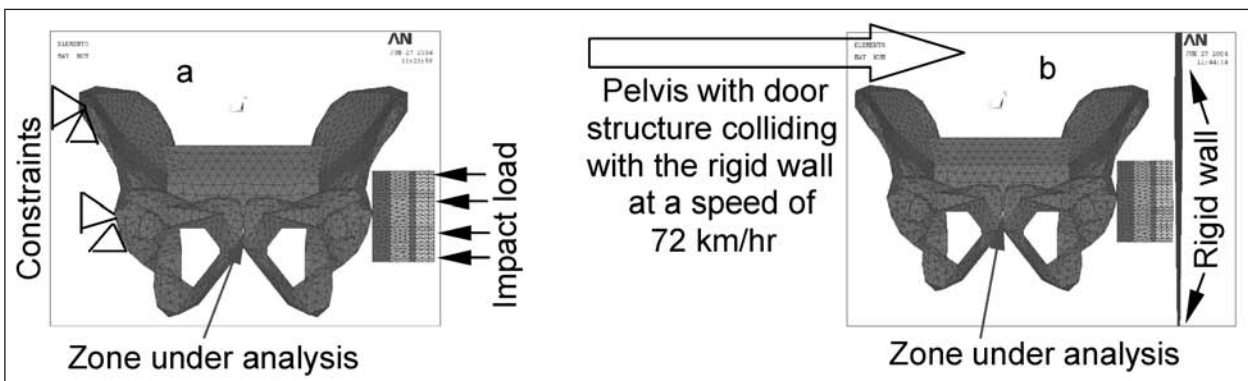

Fig. 3: Impact load cases for analysis with (a) ANSYS[®], (b) ANSYS-LS-DYNA[®] software

Impact Loading

To simulate the motor vehicle side impact situation on a finite element model, one needs to know the loading data during the impact between two objects (motor vehicle and rigid wall for example).

This may be applied in two ways: Case 1: in the form of impact load and impact duration; Case 2: in the form of velocity and acceleration. The first case was simulated with the ANSYS® software and the second case with the ANSYS-LS-DYNA® software.

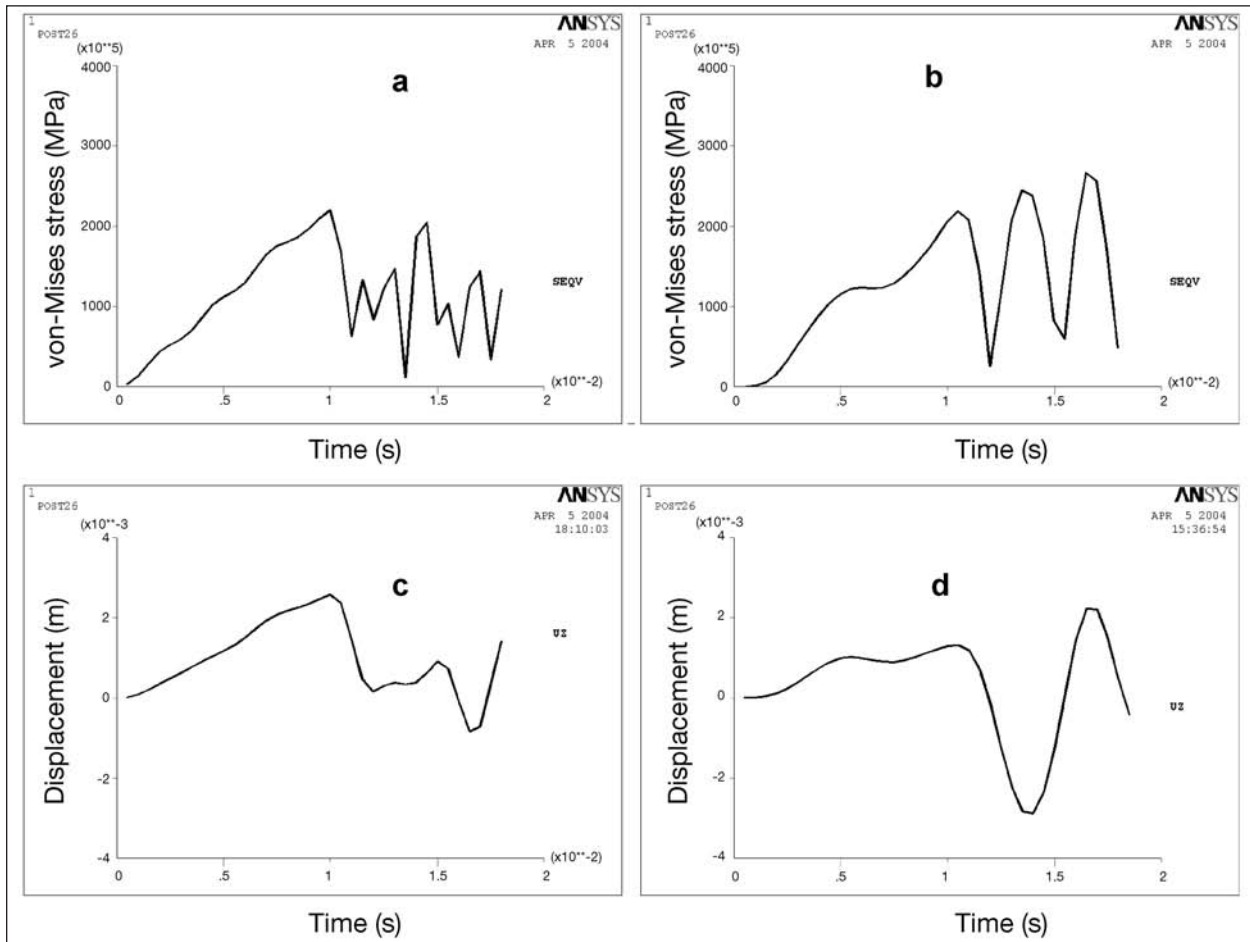

Fig. 4: Von-Mises stress plot and displacement (in the direction of impact) plot with impact duration for pelvis without car door and padding (a and c respectively) (from MAJUMDER et al. [11]) and for pelvis with car door and padding (b and d respectively) (present study), analyzed by ASIS® software

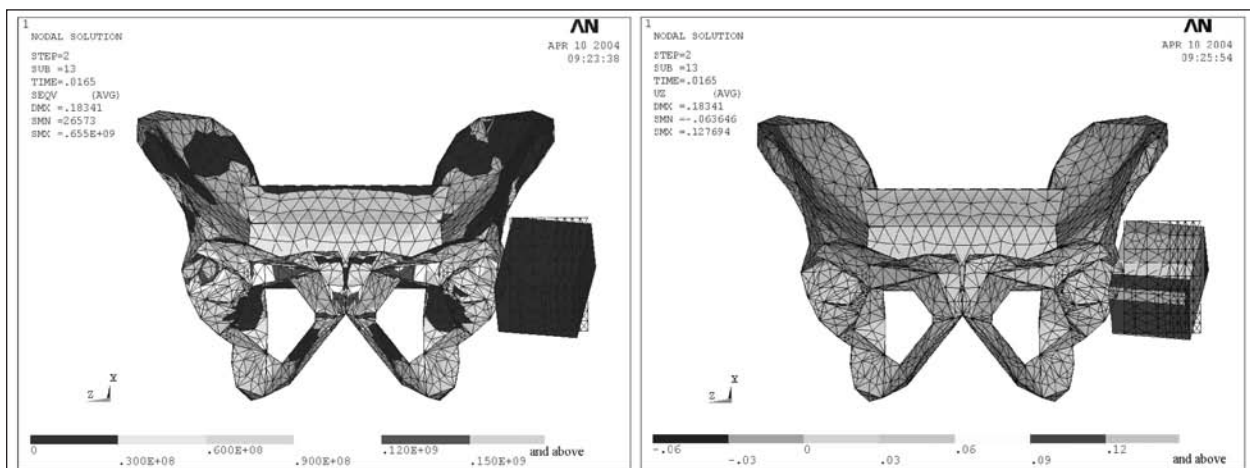

Fig. 5: (a) von-Mises stress (MPa) and (b) displacement (m) contour in the direction of impact, for the pelvis with car door structure and padding, at 16.5ms, for the first load case, analyzed with ANSYS® software

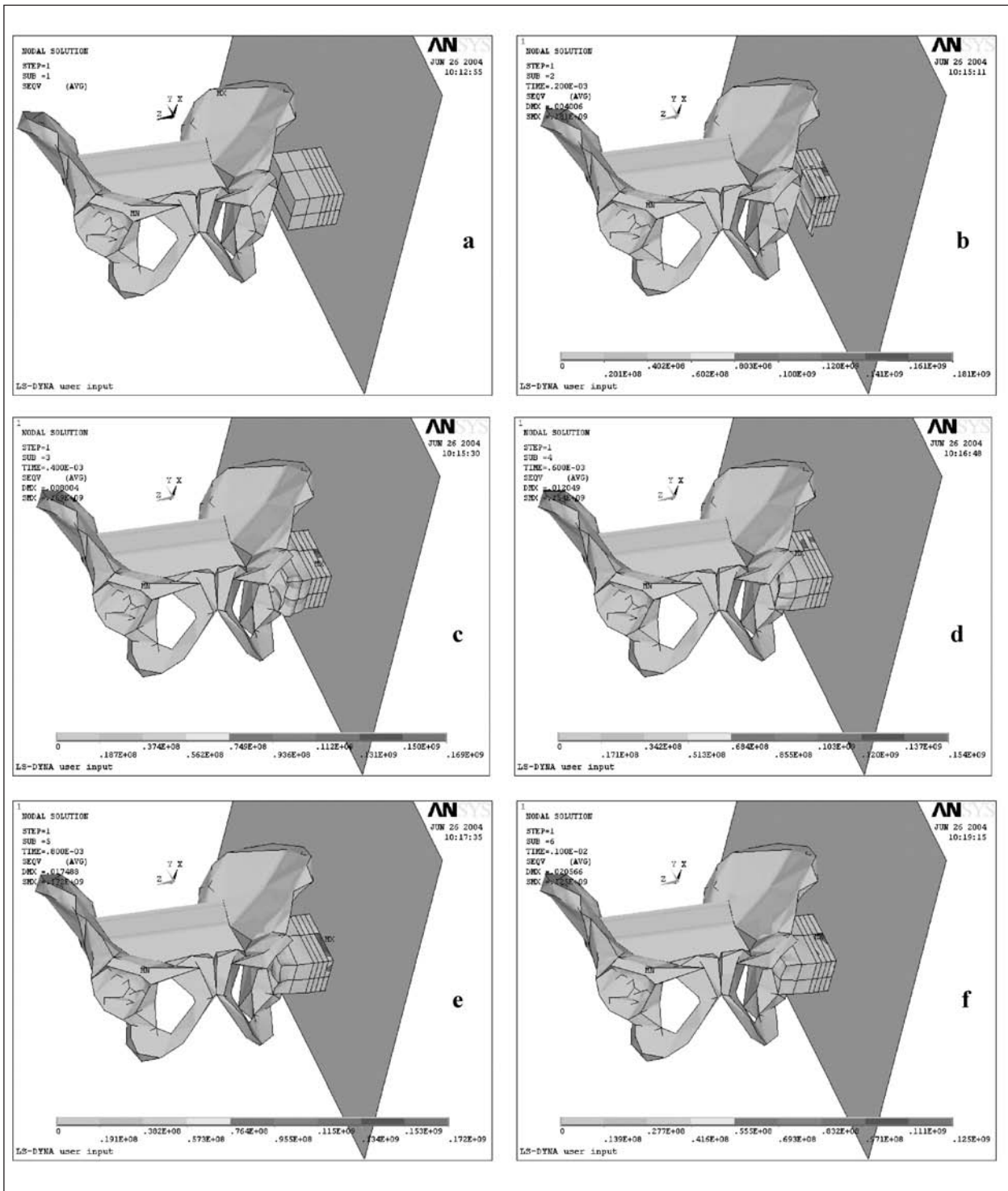

Fig. 6: (a-f) von-Mises stress contour (Pa) during different sub-time steps for the pelvis with car door and padding, for the second load case, analyzed with ANSYS-LS-DYNA® software

Load Case 1

An impact load of 5kN was applied on the outer surface (figure 3a) of the last layer (steel) for a duration of 18ms with the peak load occurrence at 10ms. As the impact load was applied to the right side in a direction from left to right, the right iliac

and right acetabulum zone were constrained to no displacement situation. This case is comparable to our previous investigation [11] without the equivalent car door structure. This case was solved with the ANSYS® software.

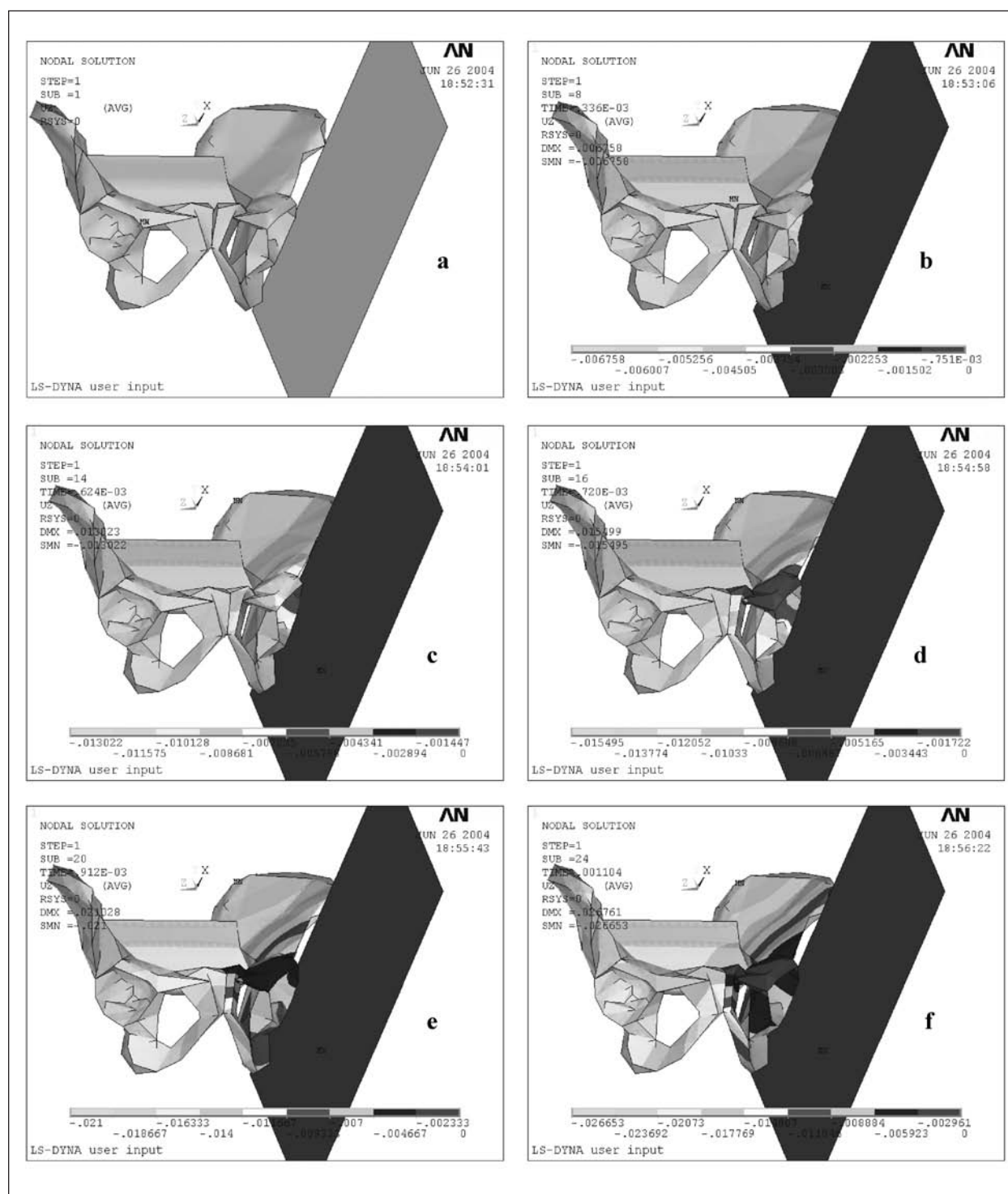

Fig. 7: (a-f) Displacement contour (m in the direction of impact, during different sub-time steps for the pelvis without car door, for the second load case, analyzed with ANSYS-LS-DYNA® software

Load Case 2

It was considered that the motor vehicle, with a velocity of 72km/hr collided with a rigid wall. The same condition was applied to the pelvic model with the equivalent car door structure (fig. 3b). To reduce the CPU time, the distance between the door outer surface (steel layer) and rigid wall was kept very low

(6mm), so that the door along with the pelvis came into contact with the rigid wall within a very short duration. The impact duration was taken as 1.2ms. Another analysis was done with the pelvic model, without the car door structure, for the same impact condition. These cases were solved with the ANSYS-LS-DYNA® software.

Results and Diskussion

For both the load cases, the von-Mises stress and displacement (in the direction of impact) criterion were considered. For the first load case (figure 3a), analyzed by ANSYS[®], it was observed that the maximum von-Mises stress (figure 4b) for a particular zone, i.e. pubic symphysis, was exceeding the compressive strength (200MPa) [16] under 5kN load case. At the end (10ms) of peak impact load, stress was 205MPa and it went on increasing up to a value of 26MPa at 16.5ms. This gradual increase depicted actual load transfer and impact absorption through car door, as compared to our earlier study, without car door and padding [11], where the highest stress (266MPa) (figure 4a) occurred at the end (10ms) of peak impact load of 5kN. The same trend was observed from the displacement pattern (figure 4c, d). The displacement in the direction of impact (figure 3a) was low at 10ms (figure 4d), as compared to our earlier findings, without padding (figure 4c). These results were also similar to the findings of the previous experimental investigations [3, 7, 13, 21]. Though the peak values were not reduced to that level during impact, the attainment of the peak values was delayed. These were due to the impact absorbing capabilities of the padding materials. The von-Mises stress and displacement contour (in the direction of impact) at 16.5ms were given in figure 5a and 5b respectively for the first load case.

For the second load case (analyzed by ANSYS-LS-DYNA[®]), the von-Mises stress contours, for the pelvis with car door and padding were shown in figure 6a-f. Displacement contours in the direction of impact, for the pelvis without car door were shown in figure 7a-f respectively. From these contours it was observed that the padding system had reduced the impact transmission effect on the pelvis by to some extent, as compared to the case of pelvis without car door. For the case without the car door, to maintain a distance of 6mm between the greater trochanter and the rigid wall, the height of rigid wall was reduced (figure 7), as compared to the rigid wall in the case of the pelvis with car door (figure 6). Hence the rigid wall did not interfere with the superior ilium and the acetabulum came into contact first with the rigid wall in both the cases.

Conclusion

Car manufacturers are becoming more and more concerned with the protection of the occupants in lateral impacts. But there are many knowledge gaps regarding the behavior of various regions of the pelvis and its biomechanical tolerance, under dynamic loading such as heavy impact due to motor vehicle accidents. This knowledge is essential in order to optimize protection devices and car structures with regard to the security of the occupants. This knowledge is also important for designing improved crash dummies or mathematical models of the car occupants. Current research in car door padding and side air bag technology have been greatly focused on the side impact force and stress distribution on the pelvis. Hence to study the behavior of the human pelvis under impact through car door, the three-dimensional finite element model with the sacrum bone and equivalent car door structure with padding, attached to pelvis was developed, with 22,967 tetrahedral and 5,820 shell elements through 5,824 nodes. From two load cases, analyzed with ANSYS[®] and ANSYS-LS-DYNA[®], it was concluded that for the cases with padding, the occurrence of peak stress and displacement was delayed and peak values were reduced, as compared to the case without padding

Acknowledgements

The authors would like to thank Dr. S. L. DELP, Associate Professor, Biomechanical Engineering Division, Mechanical Engineering Department, Stanford University, Stanford, USA, for providing the bone surface data of pelvis without sacrum. The authors would also like to acknowledge Mr. Debjit CHAKARBORTY for providing the technical expertise regarding ANSYS-LS-DYNA[®].

References

- [1] BASF Aktiengesellschaft: Ludwigshafen, Germany, <http://www.basf.de>
- [2] D. CESARI, M. RAMET, P. Y. CLAIR: Evaluation of pelvic fracture tolerance in side impact. Proceedings of the 24th Stapp Car Crash Conference, Troy, MI, 1980, 229-253
- [3] D. CESARI, M. RAMET: Pelvic tolerance and protection criteria in side impact. Proceedings of the 26th Stapp Car Crash Conference, Ann Arbor, MI, 1982, 145-154
- [4] M. DALSTRA, R. HUISKES, L. van ERNING: Development and validation of a three-dimensional finite element model of the pelvic bone. *Journal of Biomechanical Engineering* 117, 1995, 272-278
- [5] J. M. DAWAON, B. V. KHMELNIKER, M. P. McANDREW: Analysis of the structural behavior of the pelvis during lateral impact using the finite element method. *Accident Analysis and Prevention* 31, 1999, 109-119
- [6] S. L. DELP: Surgery simulation: computer graphics system to analyze and design musculoskeletal reconstruction of the lower limb. PhD dissertation, Stanford University, Stanford, 1990
- [7] H. GUILLEMOT, C. GOT, B. BESNAULT, F. LAVASTE, S. ROBIN, S. J. Y. LE COZ, J. P. LASSAU: Pelvic behavior in side collisions: static and dynamic tests on isolated pelvic bones. Proceedings of the 16th International Technical Conference on the Enhanced Safety of Vehicles, Windsor, ON, Canada, 1998, 1412-1424
- [8] A. A. HOFMANN, C. P. DAHL, R. W. WYATT: Experience with acetabular fractures. *Journal of Trauma* 24, 1984, 750-752
- [9] P. R. LEWIS Jr., F. J. MOLZ, S. Z. SCHMIDTKE, M. W. BIDEZ, P. R. LEWIS: A NASS-based investigation of pelvic injury within the motor vehicle crash environment. Proceedings of the 40th STAPP Car Crash Conference, Albuquerque, NM, 1996, 123-129
- [10] S. MAJUMDER, A. ROYCHOWDHURY, S. PAL: Variations of stress in pelvic bone during normal working, considering all active muscles. *Trends in Biomaterials & Artificial Organs* 17, 2004a, 48-53
- [11] S. MAJUMDER, A. ROYCHOWDHURY, S. PAL: Dynamic response of the pelvis under side impact load – a three-dimensional finite element approach. *International Journal of Crashworthiness* 9, 2004b, 89-103
- [12] F. L. MOLZ, P. D. GEORGE, L. S. GO, M. W. BIDEZ, A. I. KING, J. ALONSO: Simulated automotive side impact on the isolated human pelvis. Phase I: development of a containment device. Phase II: analysis of pubic symphysis motion and overall pelvic compression. Proceedings of the 41st Stapp Car Crash Conference, Orlando, FL, 1997, 75-89
- [13] G. S. NUSHOLTZ, P. S. KAIKER: Pelvic stress. *Journal of Biomechanics* 19, 1986, 1003-1014.
- [14] J. F. PERRY: Pelvic open fractures. *Clinical Orthopaedics* 151, 1980, 41
- [15] J. W. PLUMMER, M. W. BIDEZ, J. ALONSO: Parametric finite element studies of the human pelvis: the influence of load magnitude and duration on pelvic tolerance during side impact. Proceedings of the 40th Stapp Car Crash Conference, Albuquerque, NM, 1996, 17-28
- [16] D. T. REILLY, A. H. BURSTEIN: The mechanical properties of cortical bone. *Journal of Bone and Joint Surgery* 56A, 1974, 1001-1022
- [17] F. RENAUDIN, H. GUILLEMOT, F. LAVASTE, W. SKALLI, F. LESAGE, C. PECHEUX: A 3D finite element model of pelvis in side impact. Proceedings of the 37th Stapp Car Crash Conference, Washington, DC, 1993, 249-259
- [18] A. ROYCHOWDHURY: Stress & tribological analysis of artificial human knee joint. PhD dissertation, Jadavpur University, Kolkata, India, 1996
- [19] J. D. SPENCER, T. LALANADHAM: The mortality of patients with minor fractures of the pelvis. *Injury* 16, 1985, 321-323
- [20] M. TILE: Fractures of the pelvis and acetabulum. Williams & Wilkins, Baltimore, 1995
- [21] J. Y. ZHU, J. M. CAVANAUGH, A. I. KING: Pelvic biomechanical response and padding benefits in side impact based on a cadaveric test series. Proceedings of the 37th Stapp Car Crash Conference, Washington, DC, 1993, 223-233

J. Monclus
FITSA Foundation, Madrid, Spain

A Proposal for a Coordinated In-Depth Crash Investigation Programme in Spain

Abstract

Vehicle crash research at different levels is currently being conducted by several investigation groups in Spain, in some instances within various EU-funded projects. However there is a clear opportunity for increasing compatibility and maximizing usefulness, both at national and European levels, of the information collected by these groups. After reviewing on-going activities and programs in different countries, a framework for a nationwide crash investigation project is proposed: an organizational scheme is suggested as part of a future National Road Safety Strategic Plan; a map of investigation teams located in technological centres, universities and police agencies in Spain is presented; alternatives for several practical aspects such as team composition, deployment and operational budgets and project developmental stages are also discussed.

Programme Concept and Traffic Safety Policy Frame

Every year dozens of crash investigations are being conducted in Spain but the lack of data aggregation substantially limits their usefulness. FITSA Foundation (a Spanish private foundation supported by public funds whose mission is the promotion of scientifically proven measures in the field of traffic safety) is proposing the setup of an in-depth crash investigation programme in Spain. The proposal has been included in the Spanish National R&D Plan 2004-2007 [1].

The definition of this National ACCidentology PROGRAMME (NACCPRO or PRONACC) has taken into account existing crash investigation programmes both in car manufacturers such as BMW (whose team was visited in 2003) and in universities and research center such as those existing in France, Germany, the United Kingdom and the United States of America, as shown in the summary table in the appendix [2, 3, 4]. From a European perspective, this programme would anticipate the definition of a possible in-depth crash investigation pan-European programme as final result of the chain of EC funded research projects STAIRS, PENDANT and SafetyNet. PRONACC is proposed, in order to maximize its private and societal usefulness, within a new traffic safety policy framework shown in figure 1.

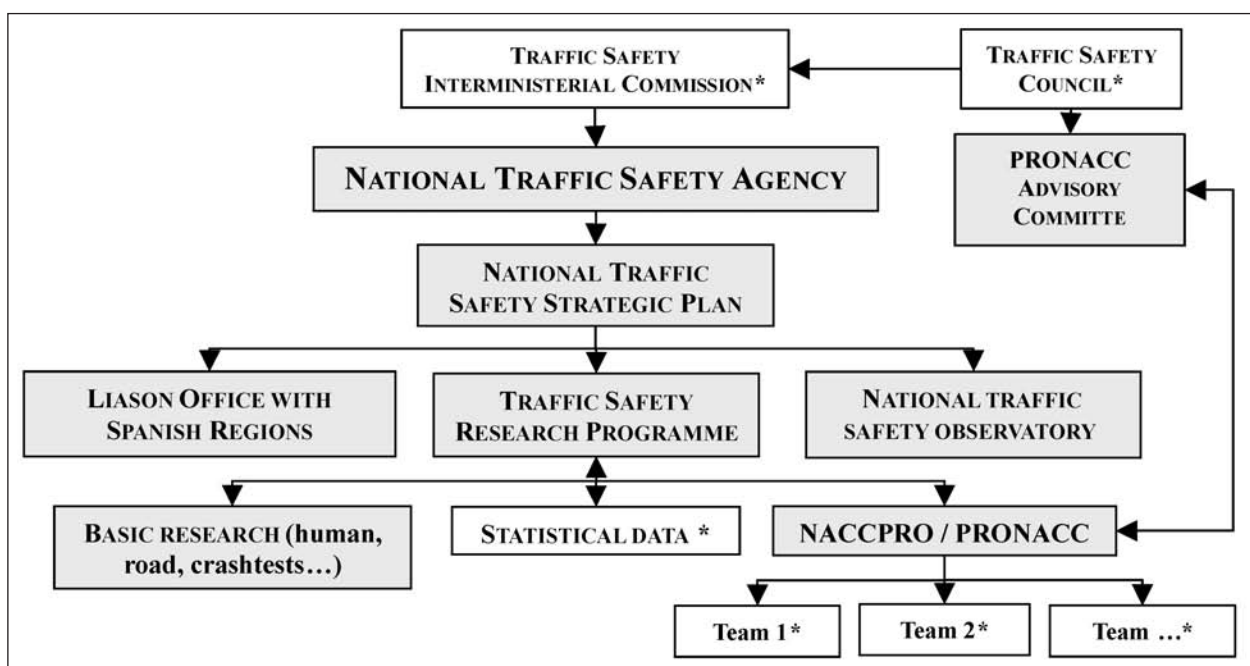

Fig. 1: Proposed traffic safety framework for NACCPRO (* = existing bodies)

At this stage of the proposal, all the items are still open to discussion with interested parties (administrations, crash investigation teams, sponsors, data users...). Therefore rather than a definitive design, this poster condenses the proposed starting point for necessary future debates. In fact, discussions have already started in the Accidentology Observatory (i.e. a group of accident data experts meeting regularly) coordinated by FITSA Foundation since the end of 2003.

Map of Crash Investigation Centers and Team Composition

The review of existing crash investigation activities in Spain has led to the map in figure 2 representing the location of available resources, many of them having accrued large experience in national and international accidentology studies (PENDANT, SARAC II, APPROSSYS, MAIDS, ROLLOVER...). Although the initial actual capabilities of the various centres might vary, they all could be brought to a homogenous minimum standard in a short period of time with the adequate training programme.

The map includes research centres such as Centro Zaragoza, CESVIMAP, CIDAUT, the recently established in Galicia CTAG, or IDIADA, university institutes such as Grupo SVyAT, INSIA or INTRAS,

car manufacturers such as SEAT, private consultant companies such as REGES and policy units such as Guardia Civil (ATGC) and Mossos d'Esquadra in Catalonia. The proposed minimum team composition consists of three members: one police officer, one technician and one physician. The participation of two technicians instead of one (one focusing on the infrastructure and the second one on the vehicle) and one psychologist is also suggested in a more comprehensive team design focusing on crash avoidance.

Timeline and Budget

The timeline for the development of a NACCPRO/PRONACC is coherent with the duration of the above mentioned National R&D Plan 2004-2007:

- Year 1 (2004): Final approval of the project (political/technical decision) and establishment of first institutional agreements and working groups.
- Year 2 (2005): Definition of details through the work of different working groups, barrier removal (data access, additional collaboration agreements), team training, database creation.
- Year 3 (2006): Pilot activities over approximately 150 crashes.

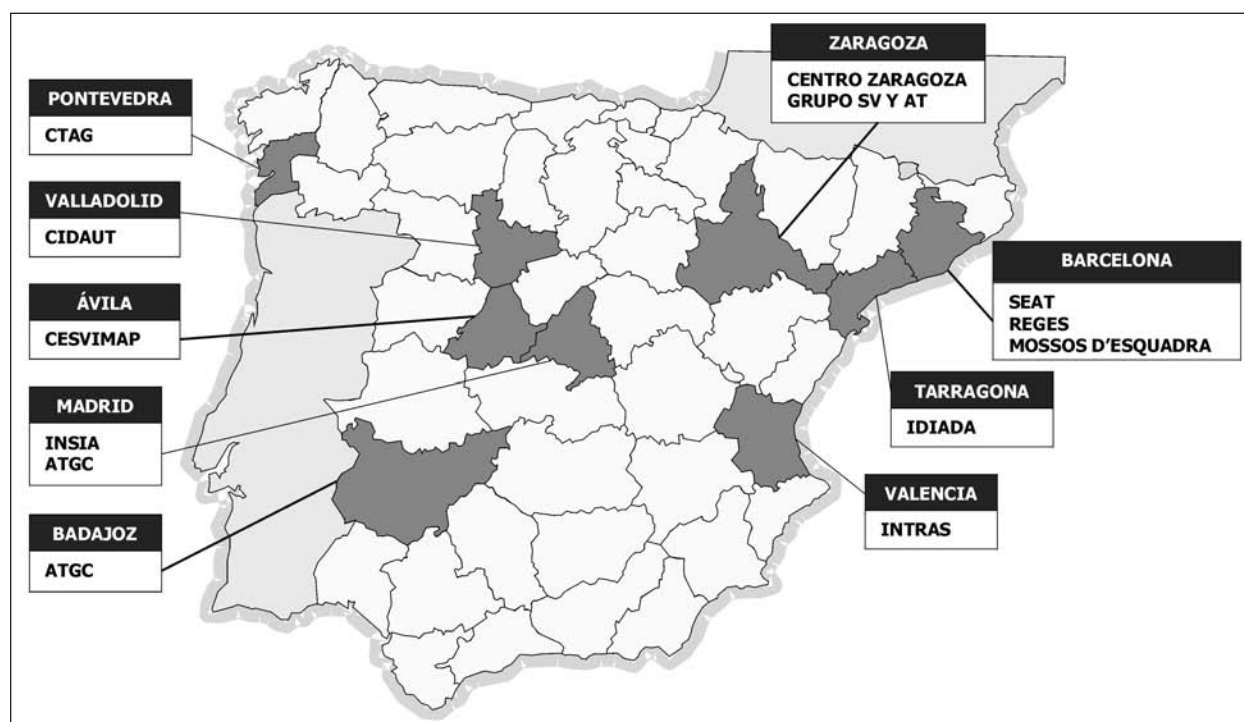

Fig. 2: Map of existing Spanish in-depth traffic crash investigation resources

- Year 4 (2007): Investigation of 1,000 accidents (same figure as for the “permanent” NACCPRO).

An estimated budget for years 1-3 has been calculated in 1.9 million euros and an estimated yearly budget for 1,000 investigations has been estimated in 3.4 million euros. A societal economical return of this activity is justified with the saving of two fatalities and their associated non-fatal casualties (using values developed by the European Transport Safety Council [5]). A mixed public (a large share of the returns are societal) and private financing scheme is being proposed at this stage.

Conclusion

This poster presents the basic concepts for a National ACCidentology PROGRAMME (NACCPRO) or a Spanish In-Depth Accident Study (SIDAS). This proposal is intended to provide a general framework for this type of investigations following the pattern of existing studies such as GIDAS in Germany in order

to maximize at national and European level the usefulness of on-going activities in Spain.

References

1. Plan Nacional de Innovación Científica: Investigación y Desarrollo 2004-2007. Ministerio de Ciencia y Tecnología. Madrid, 2003
2. Final Report STAIRS: Contract: RO-96-SC.204, 1999. www.lboro.ac.uk/research/esri/vsrc/stairs/
3. A. GEORGI: GIDAS-German In-Depth Accident Study. FISITA Congress 2004. Paper F2004V213
4. <http://www-nrd.nhtsa.dot.gov/departments/nrd-30/ncsa/NASS.html>
5. Cost Effective EU Transport Safety Measures: European Transport Safety Council. Brussel 2003

Appendix

	CCIS	OTS	INRETS-CEESAR	MUH (GIDAS)	NASS/CDS
Country	UK	UK	France	Germany	USA
Period covered	Since 1983	2000-2003	Since 1993	Since 1973 (1999 GIDAS)	Since 1979
On the spot-retrospect.	Retrospective	On the spot	On the spot	On the spot	Retrospective
Primary focus	Injury causation	General	Crash avoidance	Legislative tool	General
Case selection	Stratified	Random	Random	Random	Stratified
Team activation	Police reports	Police call		Police call	Police reports
No of teams	2 (Universities) + 5 (Gov't)	2	4	1 (2)	24
No crashes/year	1,600	500	200-240	1,000 (2,000)	5,000
No crashes/year-team	215	250	50-60	1,000	200
Coordinator	TRL			MUH (BAST)	NHTSA
Team composition		Police officer, technician and coordinator. Optionally: physicians and psychologists	Technical team and psychologist	Coordinator, technicians (2) and physician	
Budget	2.9 Mill. € approx.	-	-	2 Mill. € approx.	-
Financing sources	Public+private	Public	Public+LAB (private)	Public (Mixed)	Public
Inclusion criteria 1	At least one injured occupant		At least one victim	At least one victim	At least one victim or vehicle damage
Inclusion criteria 2	Passenger cars <7years old	All types of vehicles	At least two vehicles involved	All types of vehicles	Vehicles <4,500kg
Inclusion criteria 3	Tow-away vehic.				
Note 1	Retrospective: loss of inform.	More expensive	More expensive	More expensive	Retrospective: loss of inform.
Note 2	Only passenger cars	Higher level of police cooper. required	Higher level of police cooper. required	Higher level of police cooper. required	

P. Thomas, A. Morris
Vehicle Safety Research Centre, Loughborough,
United Kingdom

G. Yannis
National Technical University of Athens, Greece

Ph. Lejeune
CETE de S.O., France

P. Wesemann
SWOV, The Netherlands

G. Vallet
INRETS, France

W. Vanlaar
ISBR, Belgium

Establishing the European Road Accident Observatory – the SafetyNet Integrated Project

Background

The need for improved EU level accident information and data was identified in the EU White Paper on Transport Policy (2001)¹ and detailed in the Road Safety Action Plan (2003)². The plan specifies that the EC will develop a road safety observatory to coordinate data collection within an integrated framework.

What Is SafetyNet?

SafetyNet is an integrated project, funded by the European Commission under the Sixth Framework Programme. The project addresses the shortfall in accident data and will develop the structure of the

European Road safety observatory to provide a coordinated set of accident information resources for the EU, to meet the needs for data to support public policy. The project will focus on the development of the structure of the observatory and will populate many parts with data. Macroscopic data will be gathered by EU member states under an agreement between ministers³ according to technical specifications developed within SafetyNet. In-depth data will be gathered by specialist teams within the project, largely employing the infrastructure developed within the Pendant Fifth Framework Project.

Macroscopic Data

Work Package 1 - CARE Accident Data

Work Package 1 will extend the CARE database to include the data from the 10 new member states, Switzerland and Norway. It will produce a series of analyses of the complete data, the first ever that will be publicly available and will examine the issues of classification of non-fatal but serious injury crashes.

Work Package 2 – Risk Exposure Data (RED)

This WP will develop new transformation rules that will be applied to exposure data from the member

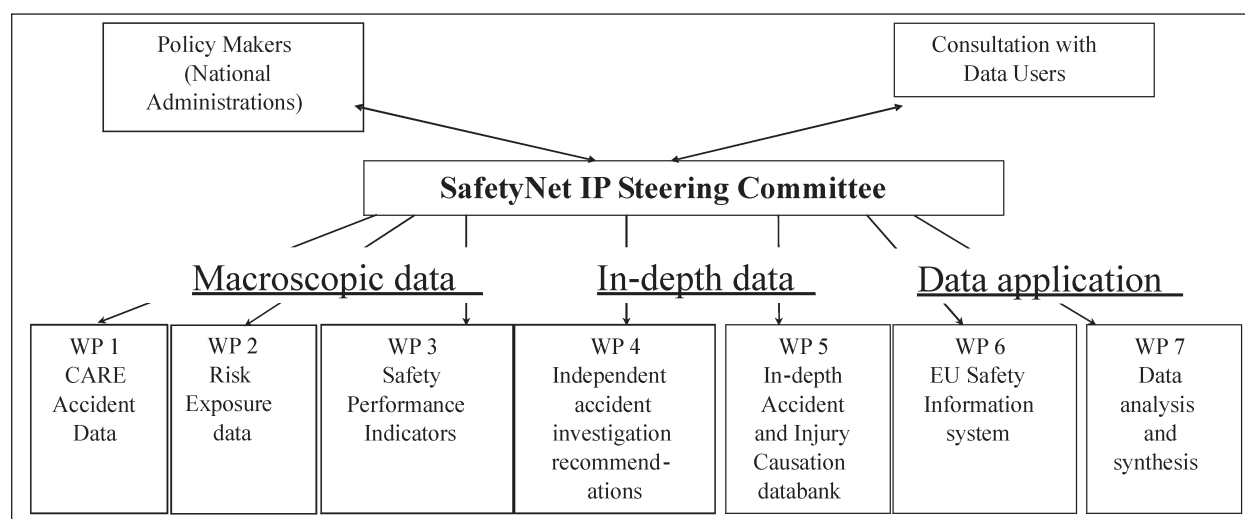

¹ European Commission White Paper, European transport policy for 2010: Time to decide, Brussels, 2001

² European Commission, Road Safety Action Plan, COM (2003) 311 final, 2.6.2003, Brussels

³ Council doc. 10753/1/03 REV 1 – discussion on the Road Safety Action Programme – conclusion #8, 5 June 2003, Brussels

states permitting comparable comparisons of accident risk for a range of conditions.

Work Package 3 – Safety Performance Indicators

Safety performance indicators are support tools to understand better the causes of accidents and to monitor policy interventions. This WP will develop a new framework within which data gathered by member states will be brought together in a comparable format.

In-depth Data

Work Package 4 – Independent Accident Investigation Recommendations

This WP will examine issues concerning “independence” and produce guidelines for assessing the independence of accident data and its analyses. It will also give guidance on constraints of existing EU legislation and particular requirements in the investigation of major accidents.

Work Package 5 – Independent Accident and Injury Databases

This WP will develop a framework for two new representative accident databases and populate them with data gathered by the project. A fatal accident database will provide details of the circumstances of 1000 fatal crashes while a new accident causation database will give particular attention to infrastructure safety and the needs of eSafety technologies.

Data Application

Work Package 6 – European Road Safety Information System

WP 6 will assemble an extensive range of information and data related to traffic accidents including the results of other SafetyNet WPs and make them accessible over the web. It will provide a single source for policy makers and researchers wishing to obtain details of accident related information.

Work Package 7 – Data Analysis and Synthesis

WP 7 will review available analysis techniques and apply them to data to demonstrate the added

value. It will focus on time dependent data and clustered data.

SafetyNet includes three main types of information. Macroscopic accident, exposure data and safety performance indicators will be gathered at national level and supplied to the project following a decision by the European Council of Ministers of Transport. New in-depth data will be gathered by the partners while the results will be analysed and made widely available over the web.

List of Partners

Project Steering Committee

- Vehicle Safety Research Centre, Loughborough University, UK
- National Technical University of Athens, Greece
- Centre d'Études Technique de l'Équipement du Sud Ouest, France
- SWOV Institute for Road Safety Research, The Netherlands
- Institut National de Recherche sur les Transports et leur Sécurité, France
- Institut Belge pour la Sécurité Routière, Belgium

Partner Organisations

- Agència de Salut Pública de Barcelona, Spain
- Bundesanstalt für Straßenwesen, Germany
- Centrum dopravního výzkumu, Czech Republic
- Chalmers University, Sweden
- University of Rome, Italy
- Finnish Motor Insurers' Centre, Finland
- Institute of Transport Economics, Norway
- Közlekedéstudományi Intézet Rt, Hungary
- Kuratorium für Schutz und Sicherheit, Austria
- Laboratório Nacional de Engenharia Civil, Portugal
- Medical University of Hanover, Germany
- Road Directorate – Ministry of Transport, – Denmark
- Swedish National Roads Administration, Sweden
- Swiss Council for Accident Prevention, Switzerland
- Technion - Israel Institute of Technology, Israel
- TNO, Netherlands
- TRL Limited, UK

**Session: Accident Prevention and Causation –
Part I**

L. Hannawald

J. Sandin, M. Ljung

B. Fildes, J. Charlton

L. Hannawald
 Technical University Dresden, Chair of Automotive
 Engineering and Transmission Technology,
 Dresden, Germany

Computerized Case by Case Analysis for Evaluation of Primary Safety Systems Regarding Accident Prevention

Abstract

Because of actual developments and the continuous increase in the field of drive assistant systems, representative and detailed investigations of accident databases are necessary. This lecture describes the possibility to estimate the potential of primary and secondary safety measures by means of a computerized case by case analysis. Single primary or secondary safety measures as well as a combination of both are presented.

The method is exemplarily shown for the primary safety measure "Brake Assist" in pedestrian accidents.

Regarding accident prevention only the primary safety measure is determined.

Primary and Secondary Safety

Real world accident data are mostly focused on the technical and medical description of accident scenarios and outcome. They are excellently suitable to indicate the benefit and for developing secondary safety measures. Secondary safety measures especially for pedestrians have positive effects regarding injury severity mitigation but they are not able to prevent accidents. Therefore primary safety systems, especially regarding the prevention of accidents, are gaining more and more importance. The scientific wording "primary safety" indicates that such measures have to be implemented with highest priority.

A sensible combination of primary and secondary safety measures is a promising way to go. Another important fact is that a combination of primary and secondary safety measures is able to operate independently.

Accident situations where the possible effect of any secondary safety measures is limited (e.g.

pedestrian impacts with overrun, side impact etc.), still effort the benefit from primary safety measures. Additionally primary safety measures can influence the accidents in any speed range.

On the other hand secondary safety still has an effect if primary safety measures can not be activated with current technology (e.g. driver does not brake, no benefit with current brake assist systems).

Computerized Case by Case Analysis¹

A computerized case by case analysis, instead of conventional single case analysis, is an important tool for representative statistical evaluations and objective results. This method is able to combine the advantages of single case analysis and virtual prototyping. It can not only help to find out significant influences due to accident causation and injury prevention, further therewith it is possible to determine benefits of existing primary and secondary safety measures or to predict the potential of future measures or systems regarding traffic safety.

This lecture shows exemplarily for pedestrian accidents the effect of the primary safety system "brake assist" with regarding to accident prevention.

Injury Risk Funktion

Injury risk functions help to understand the relation between injury severity and load criteria. For pedestrian accidents an injury risk function for the Maximum Abbreviated Injury Scale (MAIS) versus the collision speed was required.

The injury risk functions were calculated using the logistic regression method in order to describe the injury severity of the pedestrians with a mathematical formula. Therefore always a binary classification (e.g. more/equal MAIS₂→(1) and less MAIS₂→(0)) is necessary. An example of the average for each speed band is shown in Fig. 1 as a field of points.

To differentiate between the severity classes slightly, seriously and fatally injured, the correlation

¹ BECKER, BUSCH: Volkswagen AG, 2003, "Methods for the evaluation of primary safety measures"

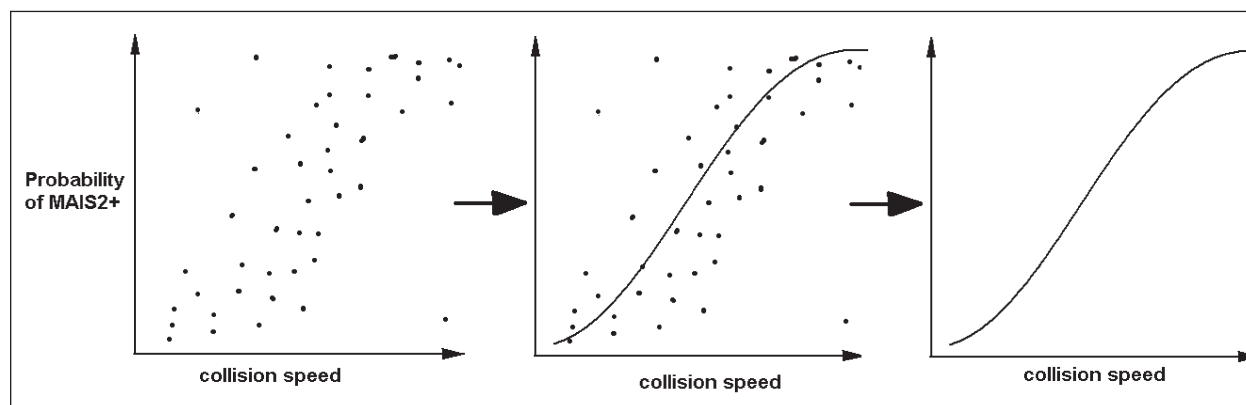

Fig. 1: Calculation of IRF using logistic regression method

between MAIS2+ and “at least seriously injured” and also MAIS5+ and “fatally injured” is shown in Fig. 2. This function gives a probability of being injured at a given MAIS level or otherwise delivers a classification of all cases at one collision speed of sustaining an injury of certain severity level (e.g. MAIS2+) or not.

Pedestrians with a MAIS2 to 4 were considered to be severely injured, those with a MAIS5 and 6 were considered as fatally injured, respectively.

Additionally it is possible to calculate the probability for pedestrians to be slightly, seriously or fatally injured depending on the collision speed, using the curves of MAIS2+ and MAIS5+ (Fig. 3).

The probability to be slightly injured as a pedestrian decreases in higher collision speed while the probability to be at least seriously injured increases. In each collision speed the sum of all probabilities has to be 100%. For example (Fig. 3), the probability for a pedestrian, impacted at collision speed of 40km/h, is approximately 30% to be slightly injured (MAIS1), 70% to be at least seriously injured (MAIS2+).

This injury risk function is based always on the same dataset used for the analysis. This fact assures, that there will be no bias due to different bases. Moreover it is possible to verify the injury risk function. For all cases in the analysis the collision speed is known and the probability of injury severity for each case could be calculated using the IRF. The sum of all predicted probabilities of at least seriously injured pedestrians should be equal to the original number of seriously and fatally injured pedestrians in the dataset. This possibility was stated as a requirement in the logistic regression analysis, so that the approximated

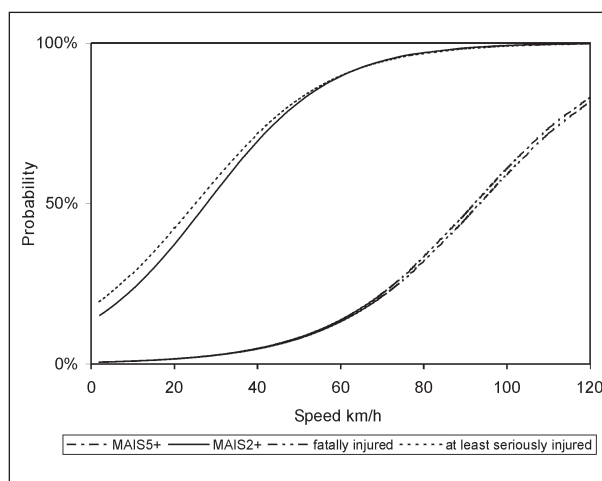

Fig. 2: Correlation between injury severity classes and maximum abbreviated injury scale

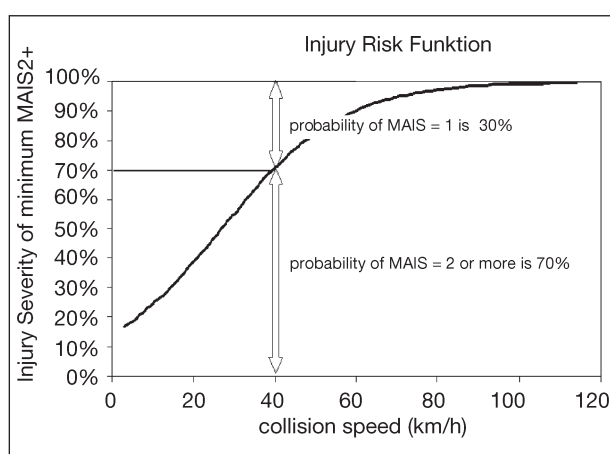

Fig. 3: Description of injury risk function

numbers of seriously and fatally injured pedestrians in the IRF are the same as the original number in the dataset. This requirement ensures accuracy for the results and minimizes the fault rate.

Effects of Primary and Secondary Safety

The possible effects of primary (BAS) and secondary safety measures are shown in Fig. 4 and Fig. 5. Secondary safety measures can reduce the injury severity of pedestrians. Therefore the effect

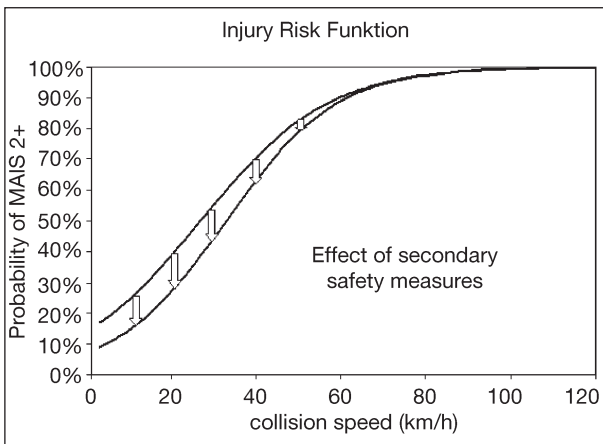

Fig. 4: Assumed influence of secondary safety measures regarding injury risk

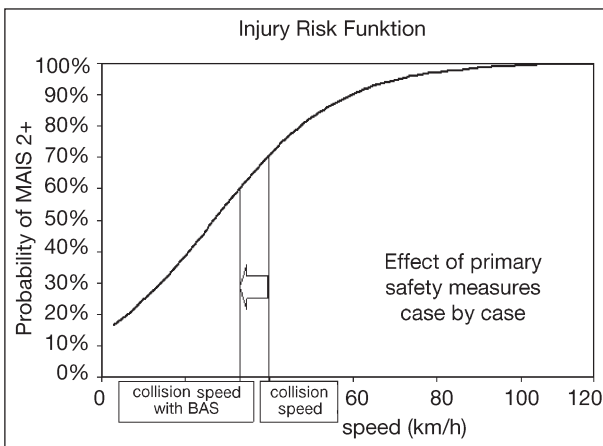

Fig. 5: Influence of BAS regarding injury risk

is a decrease of the injury risk for e.g. MAIS2+ injury severity.

On the other hand, the primary safety measure BAS has an influence on the collision speed. This influence does not directly change the injury risk function, but the collision speed as input of this IRF. In computerized case by case analysis the effect of BAS on collision speed can be predicted (Fig. 5). The overall probability of MAIS2+ injuries decreases with the reduction of the collision speed.

Current Situation

The current situation with the actual dataset was represented by an injury risk function. This was necessary for the following comparison. Therefore the real collision speed and the MAIS of the pedestrians were taken into account (Fig. 6, Fig. 7).

The probability of the injury severity class is calculated for each case using the collisions speed. The sum of all probabilities in each severity class results in the number of pedestrians in the dataset (Fig. 8).

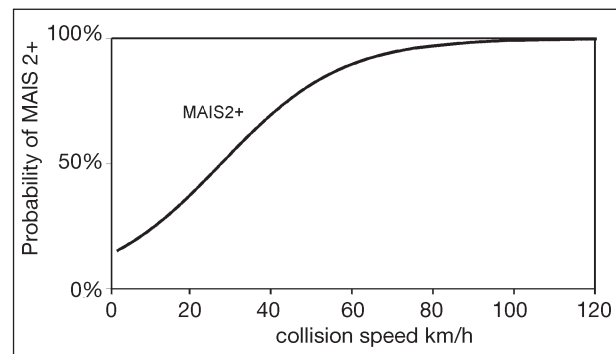

Fig. 7: Current situation – IRF

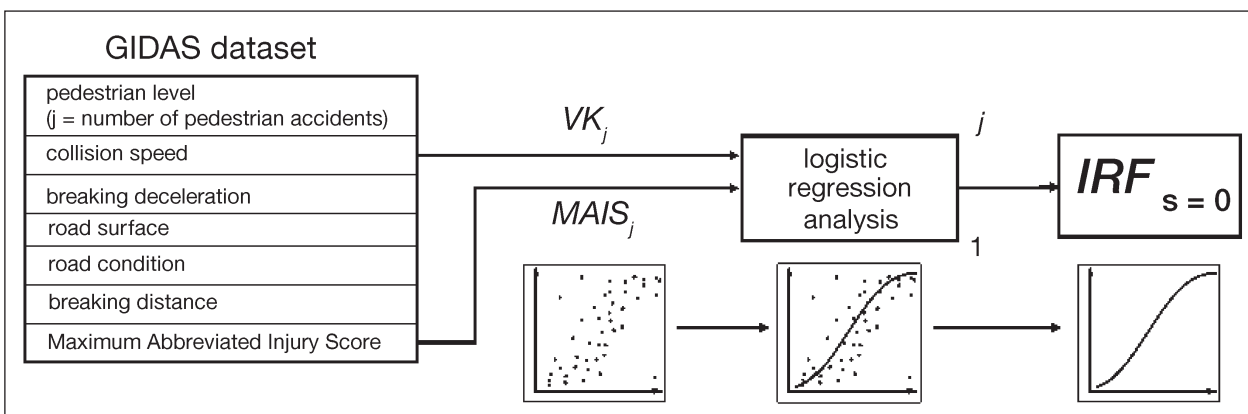

Fig. 6: Current situation – determination of IRF

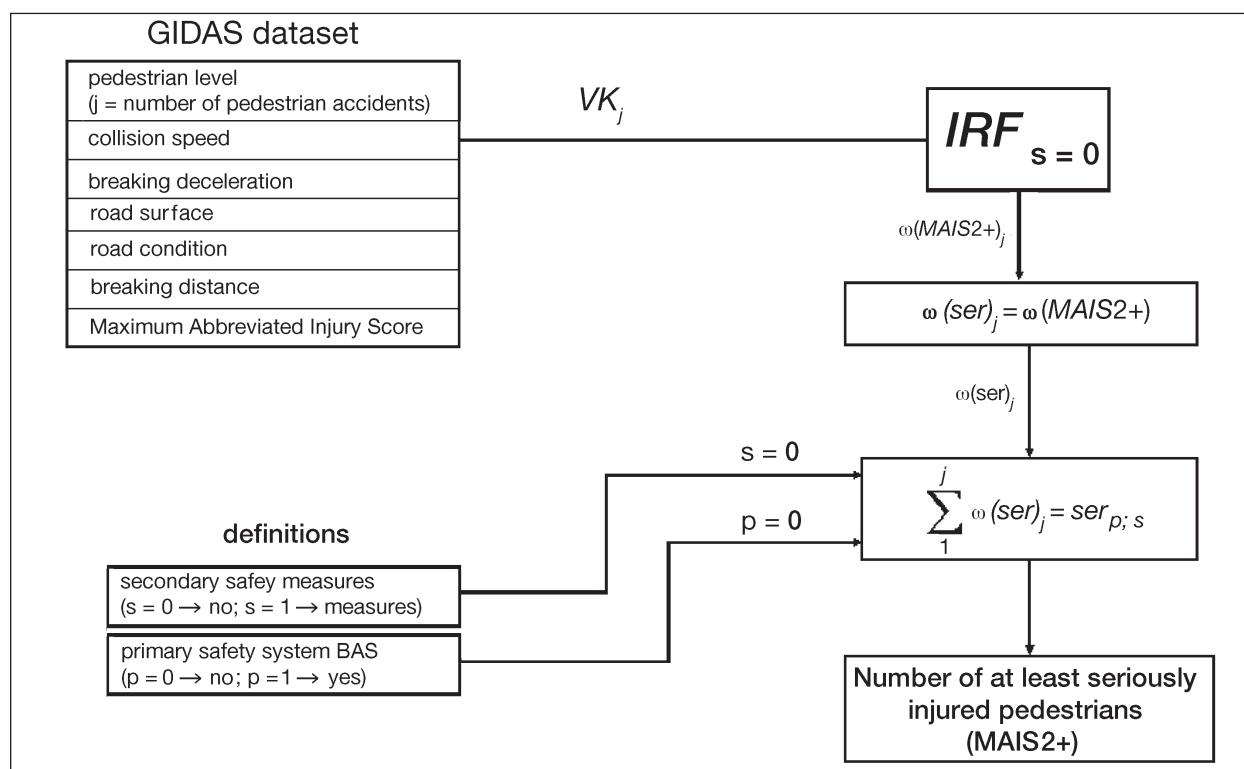

Fig. 8: Current situation – number of at least seriously injured pedestrians

Situation after Implementation of “Brake Assist”

Previous investigations suggest that the Brake Assist System (BAS) has an important influence on the avoidance of accidents.

Different crash research studies found, that although drivers reacted quickly in critical situations, they did not apply the brakes with sufficient force to achieve the highest possible deceleration. Most of the drivers who participated in the tests either could not make up their minds to brake with full force, or simply reacted incorrectly. Under normal braking conditions as well as under emergency conditions, they start out with little brake pressure and whenever necessary they will increase their pedal effort. In an emergency this behaviour can lead to a crash since valuable time (or, distance) is lost.

This finding was the rationale for developing the Brake Assist System. BAS is a controlled system helping to reduce braking distances by recognising the intent of the driver to do an emergency stop and initiating full braking within a fraction of a second. This can reduce braking distance substantially. In other words most drivers do not use the performance of the brakes – BAS automatically optimises it.

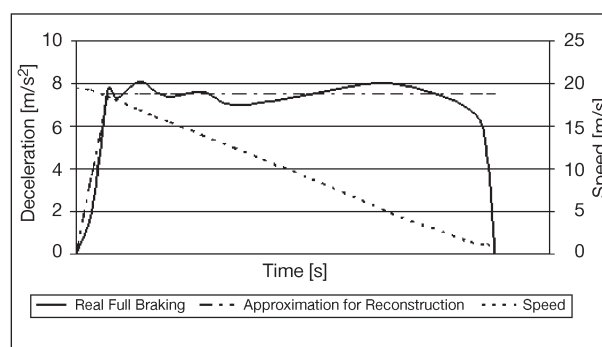

Fig. 9: Deceleration during a full brake current situation without BAS

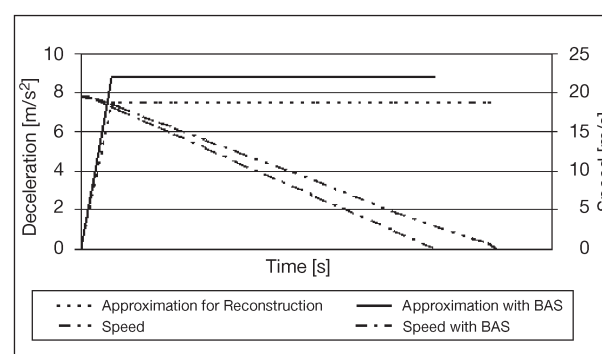

Fig. 10: Deceleration during full brake with and without BAS

Time histories of deceleration and speed are shown in Fig. 9.

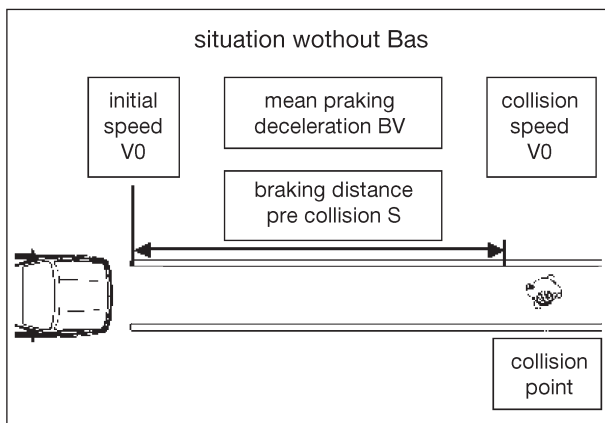

Fig. 11: Variables of accident reconstruction

All accidents scenarios in the GIDAS database are reconstructed as described regarding the initial speed, the mean braking deceleration, the braking distance pre-collision and the real collision speed (Fig. 11).

Especially the mean braking deceleration is mostly estimated using forensic literature. Based on this literature the road surface (e.g. asphalt, concrete) and the road conditions (e.g. dry, humid, wet) are important influence factors. Furthermore they declare that current vehicles equipped with antilock systems could reach a mean braking deceleration of 10–20% higher than described in the literature. Since all new vehicles will be equipped with these systems the estimated mean deceleration is always near the ceiling.

Both road surface and road condition are available in the GIDAS dataset and can be used to predict maximum possible braking deceleration if the car will be equipped with BAS.

To identify the intent of the driver to do an emergency stop, mostly the brake pedal speed, the brake pedal pressure or a combination of both is used.

The only variable in the dataset which quantifies the braking characteristics of the driver is the mean braking deceleration. Given a conservative approach the minimum of $6,0\text{m/s}^2$ mean braking deceleration was required to assume BAS activation. With this high threshold every real system would be activated. Setting the activation threshold this high also compensates for neglecting the influence of pedal speed. With this threshold of more than $6,0\text{m/s}^2$ in 47% an activation of BAS is predicted. This rate for activation of the BAS concurs with driving simulator tests.

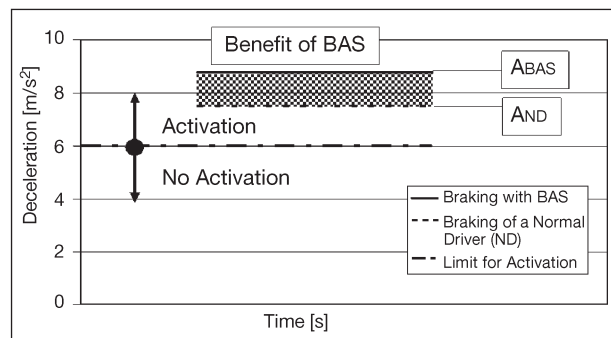

Fig. 12: Benefit of BAS

The collision speed was recalculated for all cases, independently of activation of BAS. The reduction in collision speed, as the possible effect of an activated BAS, was calculated as shown in Fig. 13. For non activation of BAS the collision speed was the same as before in the original dataset.

The effect of BAS leads to a change of collision speed.

Generally it is possible to reach a collision speed of 0km/h in certain cases, i.e., these accidents could be completely avoided due to BAS.

To determine the effect of primary safety systems, the influence in injury risk due to the change in collision speed was considered. Therefore the IRF was related to the recalculated collision speeds as the effect of BAS.

Potential of Primary Safety Systems “BAS”

To assess the effectiveness of the primary safety system BAS, the difference between the predicted numbers of at least seriously injured pedestrians of current situation and the situation after implementation of BAS in each car is decisively. That means the benefit is identified as number of saved at least seriously injured pedestrians if all cars are equipped with BAS.

If an accident was prevented with BAS, the predicted collisions speed would have to be 0km/h. Another important fact is, that with this method a combined effectiveness of primary and secondary safety systems is ascertainable.

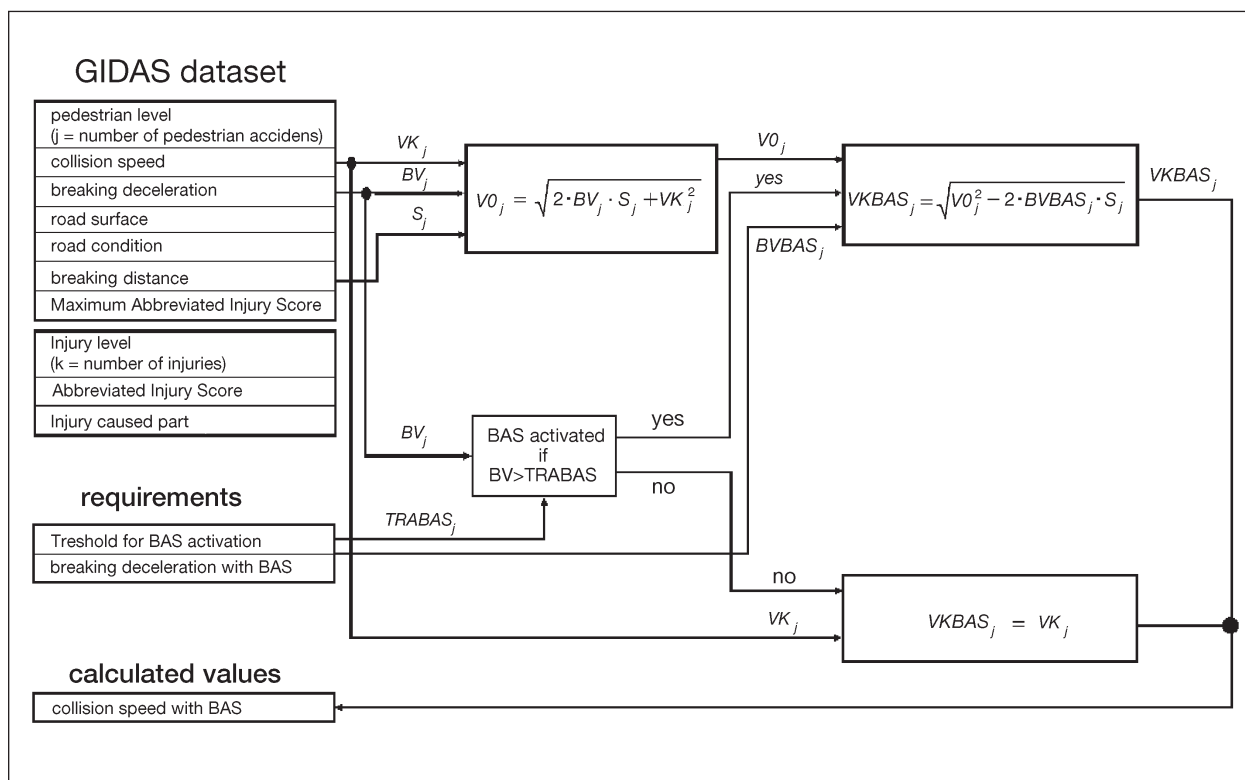

Fig. 13: Recalculation of collision speed with and without BAS

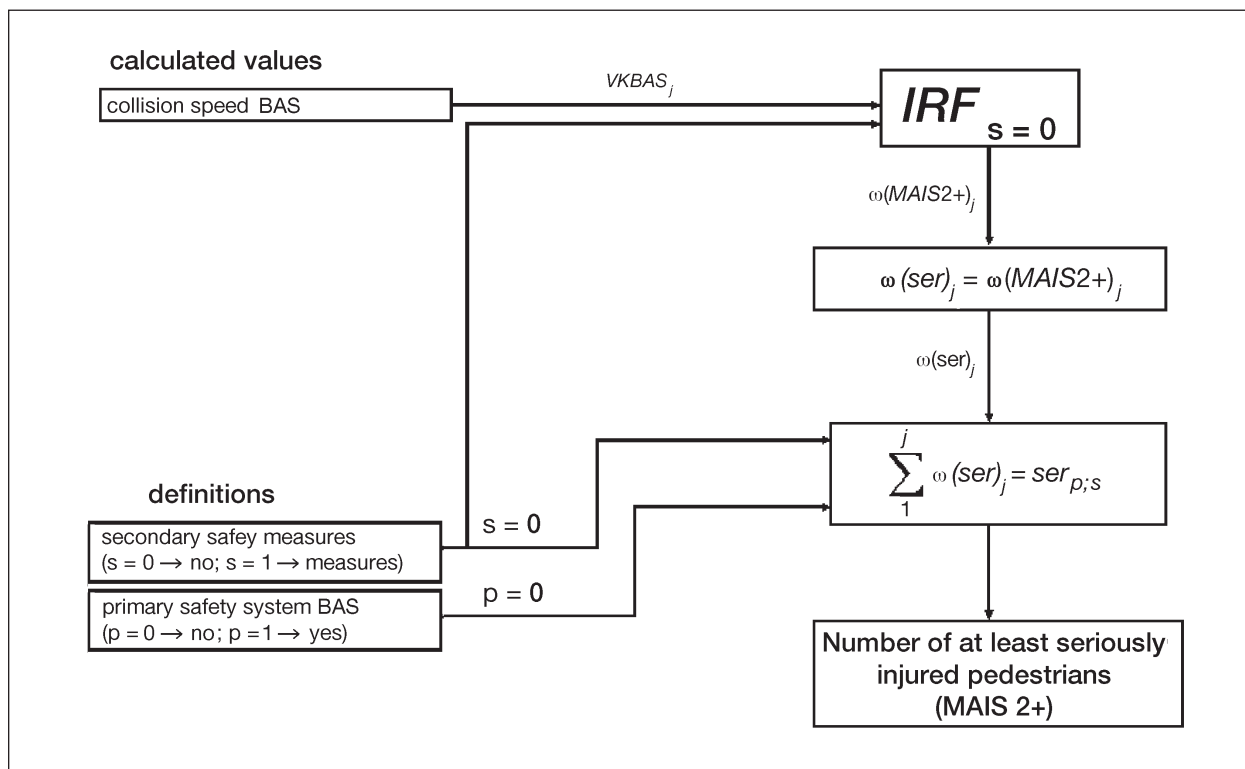

Fig. 14: BAS is equipped in all cars –number of at least seriously injured pedestrians

J. Sandin
Department of Machine and Vehicle Systems,
Chalmers University of Technology, Gothenburg,
Sweden

M. Ljung
Volvo Cars Safety Centre, Traffic Safety Analysis &
Requirements, Göteborg, Sweden

Crash Investigations for Active Safety – Meeting New Demands on Investigation Methodology

Abstract

Active safety systems are aimed at accident prevention, hence the knowledge required for their development is different from that required for passive safety systems aimed at injury prevention. Particularly, knowledge about accident causation is required. When looking at existing accident causation data, it is argued it fails to explain in sufficient detail how and why the accidents occur. Therefore, there is a need for detailed micro-level descriptions of accident causation mechanisms, and also of methodologies suitable for creating such descriptions. One study addressing these needs is the Swedish project FICA (Factors Influencing the Causation of Accidents and Incidents), where an accident investigation methodology suitable for active safety is developed, and in-depth accident investigations following this methodology are carried out on-scene in the area of Gothenburg by a multidisciplinary team. A preliminary aggregated analysis of different cases shows that the methodology developed is adequate for pointing out common contributing factors and devising principal countermeasures.

Introduction

Vehicle safety has increased significantly during the last decades due to development of vehicle structures and highly efficient passive safety systems. However, as these systems are aimed towards injury prevention, other technologies need to be introduced to reduce the total number of collisions, preferably through preventing the accidents from occurring at all. This reduction is expected to come through active safety systems.

Data from accident investigations are frequently used as a base for the development and/or evaluation of safety features. As active safety systems are aimed at accident prevention, the knowledge base required for their development is different from what is needed to develop passive systems aimed at injury prevention. While passive safety research is focused on injury mechanisms, active safety research needs to be focused on knowledge about contributing causal factors, and be formed in such a way that effective countermeasures can be developed based on the causes found.

That new methodologies are needed for accident investigation can be clearly discerned by looking at what is generally available in current accident causation analysis. Here, causes of accidents are mostly described on a coarse macro-level, through factors such as weather and road conditions, drug abuse and driver inexperience. Although these parameters are easy to collect from police reports and easy to manage statistically, they are not detailed enough for creating guidelines for active safety systems.

This last observation is especially true when it comes to knowledge about human behaviour. In analyses of traffic accidents it is often argued that the human factor, or driver errors, is responsible or involved in 90-95% of accidents [1-3]. However, accident analyses rarely explain why the human factor is involved, and it would be dubious to make direct use of these findings for the design and implementation of accident countermeasures [4]. Instead there is a need for micro-level descriptions of accident causation mechanisms, with sufficient detailed accounts of how and why accidents occur. Otherwise, efficient development of active safety systems that can detect and respond to situations associated with accident risk is hard to accomplish. Active safety therefore demands different data collection procedures for accident investigations, compared to passive safety.

FICA – Project Description

The Swedish project FICA (Factors Influencing the Causation of Accidents Incidences and) is a project aimed at developing data collection procedures that are adequate for active safety research. The project has three objectives. The first is to develop a methodology that can be used for active safety accident investigations. The second is to use this

methodology to identify factors, expressed in the domains driver-vehicle-environment, that contribute to the occurrence of typical vehicle-to-vehicle accidents. The third objective is to develop guidelines or principles for how the next generation of automotive safety systems should be designed, based on the factors identified. The third objective is primarily not aimed at providing technological support in the pre-crash phase, but to prevent the pre-crash phase from occurring at all. If you eliminate risk, you eliminate accidents.

Important Demands when Developing Accident Investigation Procedures

To achieve the objectives of FICA, two things are required: (1) detailed transcriptions of the courses of different accidents; (2) a systematic way of sorting out the threads of the accident event and finding the factors behind it. The first objective is relatively straightforward, and the procedures for doing this work will be described below. The second objective, however, needs some discussion and clarification.

In order to avoid an accident analysis to be based on individual judgement, it is necessary to have a way to systematically sort out the threads of an accident event and the factors behind it. Therefore, an accident model and an accident analysis method are two essential ingredients in every kind of accident analysis. An accident model is a theoretical framework for the accident analysis. Its purpose is to describe how a set of causes and conditions may lead to an accident, and to explain what the concepts of the model mean. An accident analysis method is a set of definitions and procedures, which the investigators follow in order to carry out every analysis in the same way. Having an accident model and an accident analysis method is very important when conducting in-depth accident causation investigations, because the model and method selected will determine which data are to be collected, in what form the results are to be presented and how they can be used [5].

FICA Accident Model

The accident model of the FICA project (see figure 1), is based on the principles of Cognitive Systems Engineering (CSE) [6]. It refers to a contemporary accident model [7], which is framed in a Man-

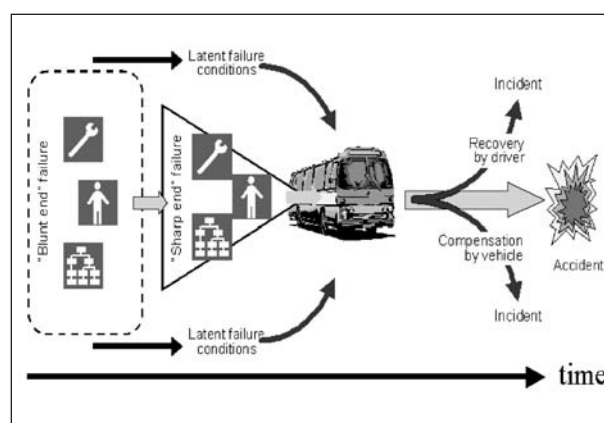

Fig. 1: Preliminary accident model of FICA

Technology-Organization (MTO) perspective. It involves latent failure conditions [8-10], and a distinction between sharp end and blunt end factors. Briefly, a traffic accident or incident is caused by the failure of the Joint-Driver-Vehicle-System (JDVS) at a certain point in time and space (a sharp end failure). However, the analysis of the causes behind the event must include also factors at the blunt end, that is factors that can be remote in space and time and yet contribute to the course of the event. Consequences of a blunt end failure (such as an improperly fastened tyre) remain in the system as latent conditions if they are not corrected, and can contribute to an accident scenario (the tyre comes loose during an evasive manoeuvre, for example).

FICA Accident Analysis Method – DREAM

The analysis of the accident data is carried out using a method called Driving Reliability and Error Analysis Method (DREAM) [11]. DREAM is developed within the FICA project and is an adaptation to the traffic safety domain of the more generic Cognitive Reliability and Error Analysis Method (CREAM) [12]. Analysing an accident with DREAM takes place in two steps. First, an evaluation of the context from an MTO-perspective for the event is made. This evaluation is done by assigning values in a table to a set of so-called Common Performance Conditions (CPCs). Each CPC represents the state of a contextual variable affecting the general performance of the JDVS (Joint-Driver-Vehicle System) in a traffic situation.

Second, a detailed analysis of the accident scenario is made, with the context description as support.

This analysis is carried out using the DREAM classification scheme. On the highest level the scheme distinguishes between the effects that are present in a situation, and the causes of those effects. The effects are classified as belonging to different phenotypes, where the phenotypes represent possible ways for a dysfunctional behaviour to manifest itself in the dimensions of time, space and energy. The causes of the effects are called genotypes. Every genotype is a factor which can be used to describe what has brought about, or can bring about, the effects.

Causes typically cannot be observed, but must be inferred by reasoning. In addition to listing possible factors that can cause dysfunctional behaviour, the DREAM classification scheme therefore also describes the links between them. The links can be said to represent existing knowledge about how different factors (causes and consequences) can interact with each other. The purpose of a DREAM analysis is to find a probable connection among these factors; a connection that can explain the observed consequences or the event phenotype.

One important advantage of the DREAM methodology is that the results of the individual cases analysis can be aggregated in order to discover causation patterns among different groupings of accidents. How this works will be demonstrated below.

Accident Investigations in FICA

Identification of Typical Accidents for In-Depth Investigations

Accident types can be classified in many ways. In this project, the classification used by the Swedish National Road Administration (SNRA)

was adopted. The reason for this is that the accident investigations are conducted in Sweden, and therefore it is easier to compare with statistics based on Swedish accident categorisations. Besides the SNRA database [13], several accident data sources were surveyed and two extra data files were selected because of their high validity and compatibility with the SNRA classifications. One is the Statistics of Road Traffic Accidents in Europe and North America Accident Data File [14]. The other is the European Accident Causation Survey (EACS) [15].

To decide typicality, several sorting criteria can be used. These include frequency, fatalities, injuries, and various indexes, such as Disability Adjusted Life Years (DALY). Because the purpose of FICA is to identify the factors that lead to accidents, using consequence-related criteria is misleading. Two accidents can have the same causes but very different consequences, depending on how or where they happen (falling asleep at high speed as compared to low speed). Therefore, the frequency criterion was chosen as a definition of typicality, and evaluated in a car-to-car perspective, since the development of countermeasures in FICA will be directed at in-vehicle technologies. Using this criterion on the data from the three files, two typical accident types were identified; ‘single vehicle’ accidents and intersection accidents (crossing/turning) (Figure 2).

Accident Investigation Procedure

The multidisciplinary accident investigation team consists of investigators with expertise in driver behaviour as well as vehicle design and vehicle dynamics. When necessary, expertise on infrastructure can be included through cooperation

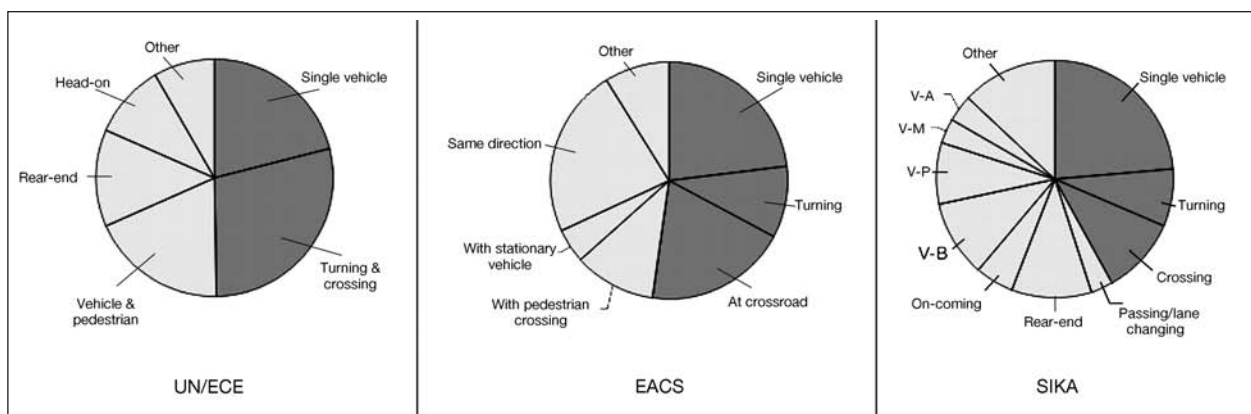

Fig. 2: Proportion of single vehicle and intersection accidents in three databases [13-15]

with local traffic authorities and the Swedish National Road Administration.

Accident alarms are automatically sent to the investigation team from the regional emergency central as an XML-file distributed by email (also to a mobile phone). The XML-file arrives within one or two minutes of someone calling the Swedish emergency number (112) and reporting a traffic accident. Accident alarms are received from the whole region of Västra Götaland in the south-west part of Sweden. However, for on-scene investigations to take place, the area is for practical reasons limited to a 30 minutes drive (corresponding to about 30km radius) from Gothenburg City Centre. Alarms are received twenty-four hours a day, but the team restricts investigations to Monday through Friday during normal working hours (08.00-17.00).

The average time for arriving at the accident scene is 15-30 minutes. Since the team does not include rescue service personnel, it cannot drive faster than normal speed limits. Because the XML-file in most cases includes GPS-coordinates for the accident, the accident scene is usually easily navigated to. The team experience is that the GPS-service both decreases the time to reach the accident scene and the stress felt while driving to the scene.

On the scene, the team establishes contact with rescue services and police, and then tries to create a description of the accident site and context as close to the course of events as possible. This includes getting the vehicle rest positions and deformations for later technical reconstruction, as well as identifying the point of impact, tire tracks and debris. The positions of the evidence are put on a sketch for a later scale-to-scale digital sketch. A digital camera is used for further documentation of the scene and vehicle state. A digital video camera is also used to film the driver's view driving up to the point of the accident.

Drivers remaining at the scene are interviewed about their experience of the accident. The interviews are audio recorded for later review. If the driver is no longer on the scene, an in-depth follow-up interview is made as soon as possible after the accident. The interview follows a protocol set up to correspond to the accident analysis method, and is performed in an informal, conversation like way, to make the driver feel comfortable and avoid hesitance [16].

Preliminary Analysis

After the scene investigation, a preliminary accident analysis is conducted using the collected material. In this preliminary analysis, some initial theories about the accident circumstances are drawn up. Also, the need for follow-up data collection is discussed, where additional data concerning the driver, vehicle and accident site can be collected to clarify the accident circumstances. Information about the involved vehicles is retrieved from the Swedish national vehicle registry which the team has access to on-line.

Technical Reconstruction

If the quality of the information collected from the accident scene is high enough to sufficiently describe the vehicles rest positions, identified point of impact, tire tracks and debris, a simulation in PC-Crash [17] is made. This simulation results in a scene-based and kinematical reconstruction which can be used to either confirm or reject some hypothesis regarding e.g. impact velocities and emergency manoeuvres up to a few seconds before impact. In some cases a damage based reconstruction is made using AI Damage [18] and correlated measurement protocols for measuring the vehicles deformations.

Final Analysis

Once a month there is an in-depth study meeting where collected cases are discussed together with experienced accident investigators from Volvo Cars, Volvo Trucks, and Saab Automobile. In these meetings, the task of the delegates is to comment on the preliminary case analysis performed by the team. After thoroughly discussing the cases and forming a final analysis, cases are filed and stored.

Examples of Individual Case Analysis and Aggregated Factors Analysis

In the following, an example from the FICA in-depth studies is shown, as well as an example of what can be achieved through aggregating the analysis results, which is possible using the DREAM method.

Individual Example Case

Type of accident:	intersection accident
Time, month:	10:10, August

Light conditions: Sunny. Because of the sun angle and nearby buildings, the Peugeot lane was in deep shadow, while the Toyota lane was in bright sunshine. The sun angle was 45 degrees up and 45 degrees to the left from the Toyota driver's field of view.

Traffic environment: Urban intersection, both vehicles travelling on primary road

Road surface condition: dry

Speed limit: 50km/h

Vehicles involved: Peugeot 206, 2001, in good condition
Toyota Corolla, 1999, in good condition

On an urban street, a Toyota (T) with a 58 year old male driver approached a crossing (see figure 3). The driver had the radio on and was driving in moderate speed (40-50km/h). He works as a construction site supervisor, and was out to pick up some blueprints at the copy centre next to the car park. He was just about to turn left onto the side street when a road-work to the right caught his attention. He had the indicator turned on but did not stop since he had not seen any approaching vehicle. He afterwards estimated his approaching speed to be 20-30km/h.

From the opposite direction, a 23 year old male driver in a Peugeot (P) approached, heading

straight. The driver had his car stereo on quite loud and was driving fast, 60-65km/h according to his own estimation. The young man was in a hurry since he had just been home (1km away) to pick up some study material which he had forgotten for a student project meeting at the college 300m further down the road from the intersection.

The young driver noticed the Toyota but did not see its indicators, and was surprised when the Toyota suddenly turned right in front of him. He thought that he just had time to put his feet on the brakes right before the impact. At the impact he felt as if the car was lifted up in the air and that the brakes lost their efficiency after the impact.

The Toyota spun around 270 degrees and came to rest with the front wheels against the sidewalk. The Peugeot continued with a slight angle to the right and came to rest after 23m right in front of the car park wall (see figure 4). Both vehicles had airbags on driver and passenger side which deployed in the collision. The Toyota driver wore a seat-belt, but suffered a rib fracture on the lower right side due to an impact against the Toyota's mid console. The young man in the Peugeot was not wearing a seat-belt at impact. The only damage he suffered however was small cuts on his forehead, from hitting the laminated windscreen.

Using PC-crash to reconstruct and simulate the crash, the speeds prior to impact were calculated to be around 70km/h for the Peugeot and 17km/h for the Toyota. These velocities are supported from a damage based reconstruction using Ai Damage

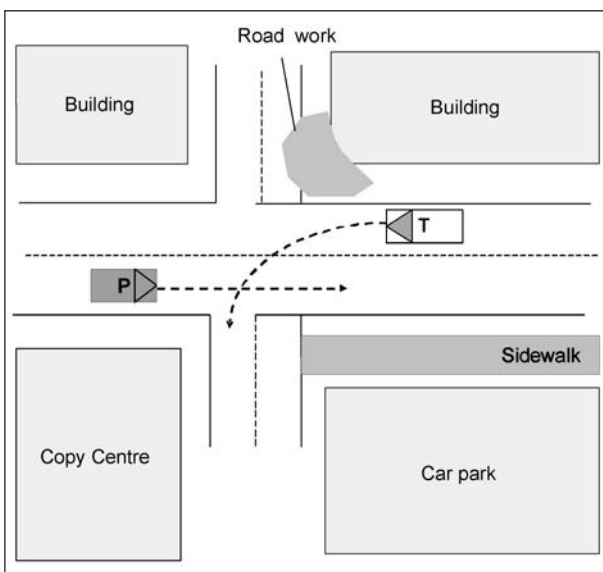

Fig. 3: Vehicle movements prior to collision

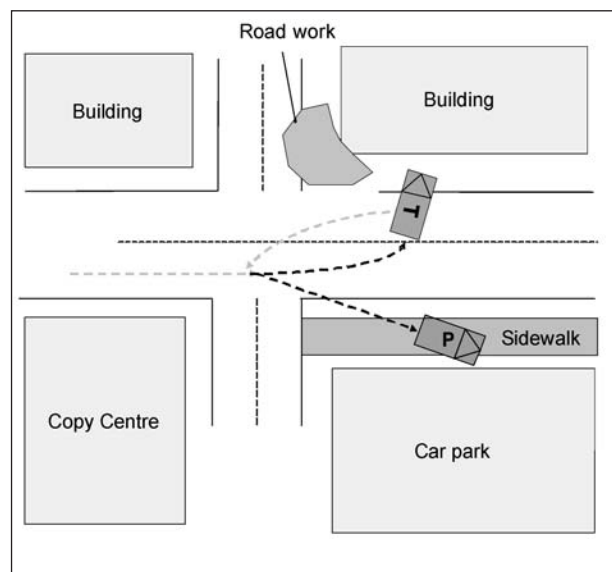

Fig. 4: Vehicle rest positions after collision

and the damage measurement protocols prescribed for this method.

The final analysis result from this accident is documented in a DREAM-diagram where the contributing factors and their links are depicted.

The diagrams should be read from left to right, where the rightmost box represents the phenotype (the error state immediately prior to the collision). The DREAM-diagrams for the example case are shown in the figures 5 and 6.

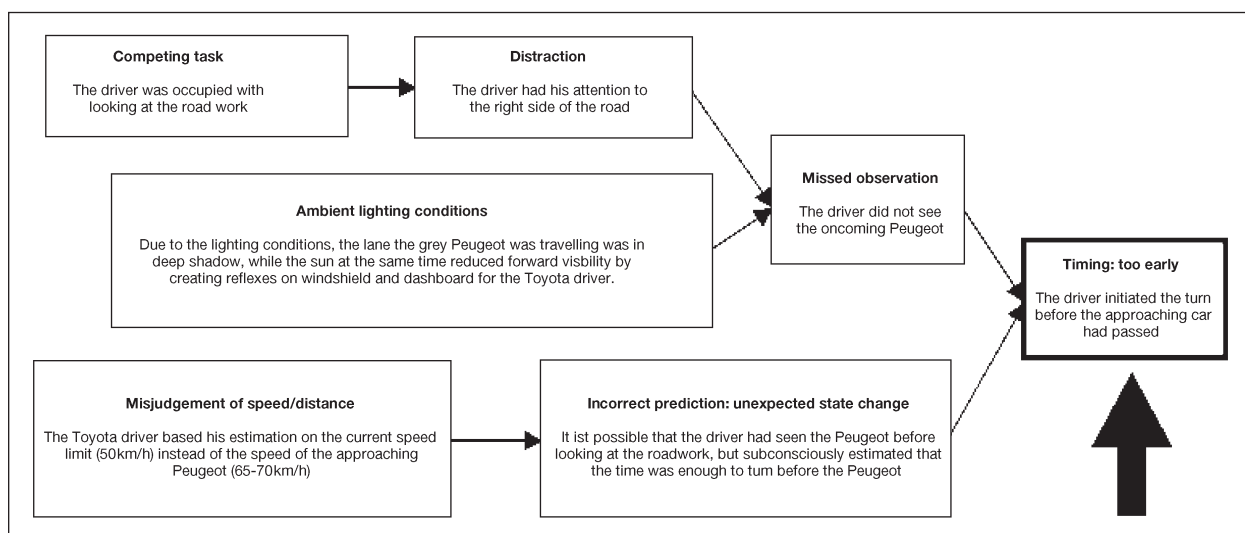

Fig. 5: DREAM analysis for the Toyota

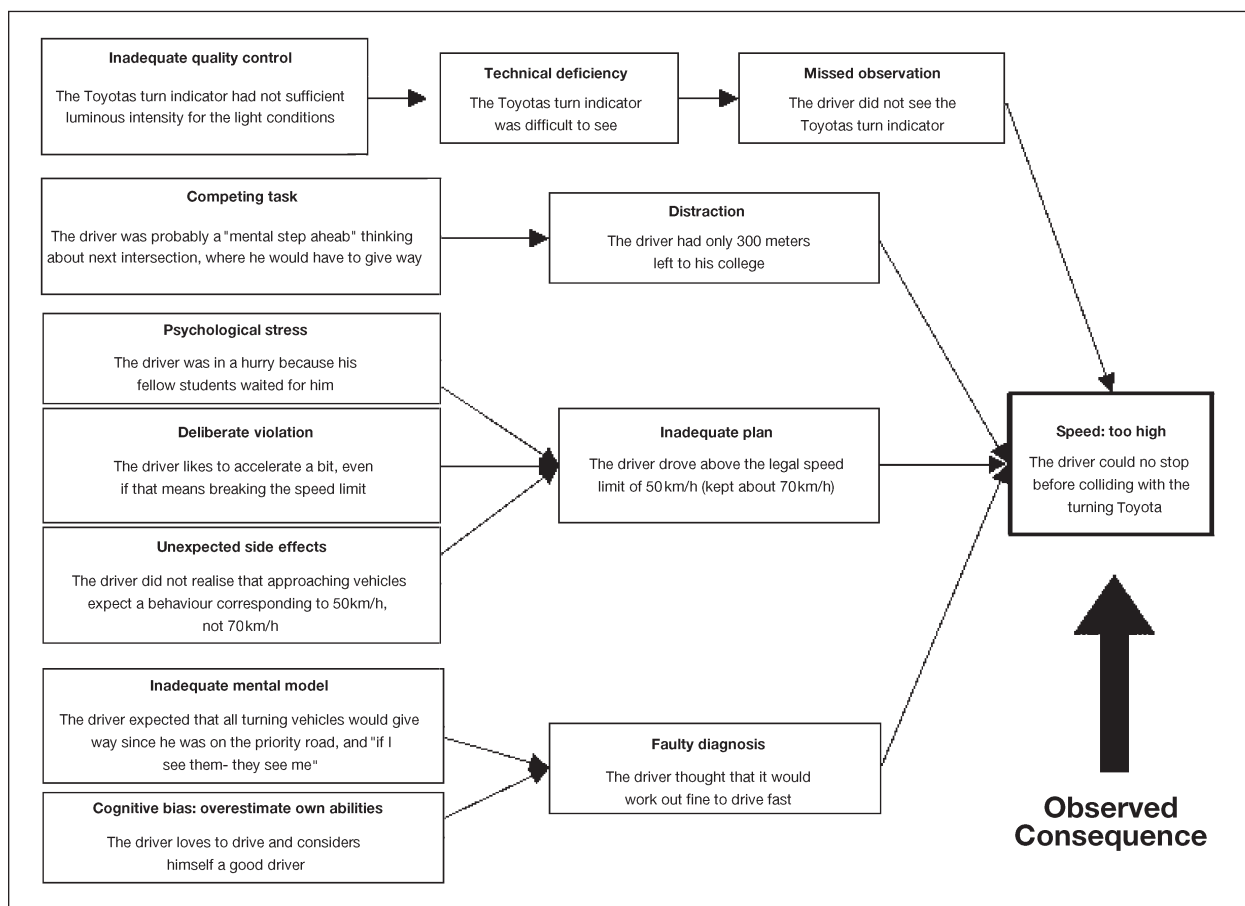

Fig. 6: DREAM analysis for the Peugeot

Example from Aggregated Factors-Analysis

As mentioned above, the DREAM-analysis method makes it possible to make an aggregate analysis of groups of accidents by superpositioning the causal links from the classification scheme. This is a useful tool when looking for patterns in accident causation. In the example provided below, five intersection cases (including the one described above) were selected based on vehicle movements prior to the accident (see figure 7).

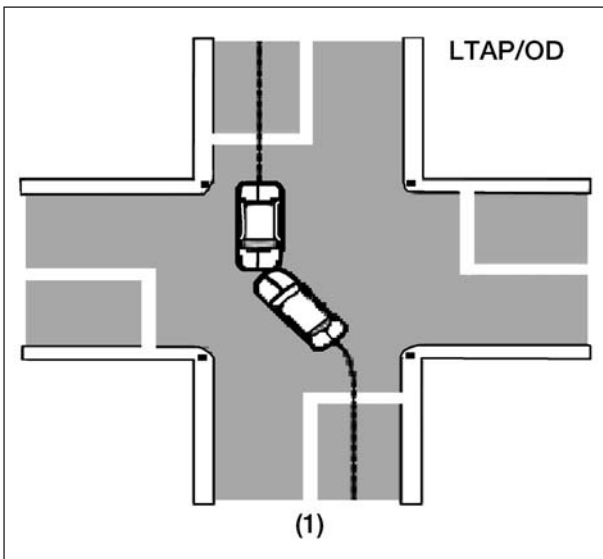

Fig. 7: Vehicle turns left across the path of oncoming vehicle from opposite direction

In the aggregated analysis (see figure 8) the individual analyses for each of the left turning drivers have been aggregated in such a way that the frequency of the causal links is illustrated by arrow thickness.

Analysing this figure, several patterns in the contributing factors emerge, distributing themselves over the whole spectra of possible MTO-factors (Man-Technology-Organisation) available for the analysis. Beginning with the M-factors, three of the drivers were distracted by a competing task, and two of the drivers made incorrect predictions about the speed of the approaching vehicle. Next, in the T-factor area, there is one case where the design of the vehicle contributed to reduced forward visibility (the glare-factor above). Last, several O-factors have contributed. For example, three of the drivers have not had enough information available, due to inadequate traffic environment design.

A note of caution is of course in place when doing the aggregated analysis. It needs to be remembered that the results and conclusions from the accident investigations are case investigations. The possibility to make generalized conclusions from these cases is therefore limited, at least until the number of cases reaches statistical significance. What also has to be taken into consideration is the hours for which the accident

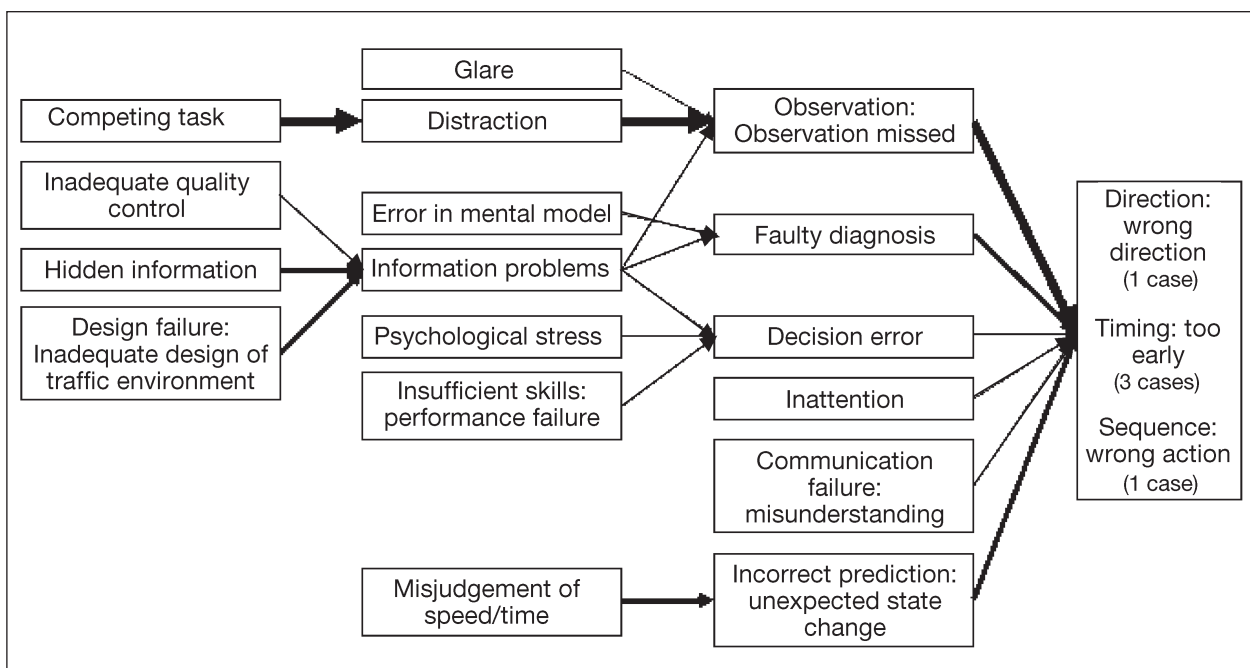

Fig. 8: Aggregate DREAM analysis for left turning driver in five intersection collisions. (To make it readable, only the headlines and not the detailed descriptions in each box is included. The conclusions below however, are based on the full material)

investigations are scheduled (Monday to Friday, 8.00-17.00), which might give a bias towards accidents typically occurring in this time interval.

Discussion and Conclusions

As an accident investigation method, in-depth case investigations can be argued to be crucial for accident causation studies, since it is necessary to get a micro-level causation description of events in order to develop efficient countermeasures. Comparing accident analysis methodologies for active and passive safety, it can be said that the analysis of the pre-crash phase through technical reconstruction from kinematics might, if data quality is sufficient, explain how an accident occurred from a physical point of view, which is very useful for the reconstruction of injury causation mechanisms.

A technical reconstruction however is not satisfactory when analyzing why or how an accident occurred from a psychological point of view, which is crucial when investigating accidents in order to develop and evaluate countermeasures for accident prevention. Also kinematical reconstructions can only explain the accident event physically milliseconds, or seconds prior to the accident. This time scope is very limited and can be used only for conclusions regarding an emergency phase just before a crash.

However, it can be argued that the challenge for accident prevention measures is to prevent an emergency situation from occurring at all. Hence, the circumstances which may have contributed to the accident must be considered when analysing accidents for prevention measures. Also, it is necessary to find the causation factors which are involved in the majority of accidents, and not concentrate countermeasures on a factor which is unique to only one accident [19].

The methodology developed in the FICA project shows promising results in this regard. It provides a tool for consistent and detailed accident analysis, and by aggregating the results of each analysis in the way exemplified above, questions of why, how and how often can be answered in sufficient detail to identify principal solutions that address the identified contributing factors. For example, the fact that several drivers were distracted by a competing task shows that one appropriate countermeasure would be to redirect driver

attention to a vehicle approaching at collision speed and course, especially when the approach is unexpectedly fast (the approaching driver drives faster than the legal limit).

In-depth accident studies on scene are acknowledged as being resource demanding, and sometimes it is argued that in-depth accident investigations should be conducted after-the-fact instead. However, the team's experience is that the time used for reaching the accident site and conducting an on-scene investigation is less than the time needed for tracing all the necessary information after-the-fact. This is partly due to the efficient on-line alarm system, which gives the team immediate and accurate accident information.

Future Work

While doing the in-depth studies, it has become apparent that both the accident model and accident analysis method of FICA need partial revisions. Certain concepts and interactions in the model need to be clarified further, and in the method, certain factors and links should be added in the DREAM categories, mostly within the organisational and traffic environment areas. This is in line with expectations. It is believed that with continued work, the in-depth studies and the more theoretical parts will iteratively continue to refine each other, resulting in a methodology that is well adapted to the active safety domain in the end. The improvements to model and method give a better tool to conduct the studies, which in their turn suggest alterations and improvements in the model and method.

Work on achieving the third objective of FICA (to develop guidelines or principles for how the next generation of automotive safety systems should be designed) will start in the beginning of 2005, when the in-depth data collection phase has finished. The collected cases will be thoroughly analysed according to the principles described above, and form the base for this work.

Acknowledgements

The FICA project is carried out in cooperation between:

Autoliv Research
Chalmers University of Technology

Linköping University
 Saab Automobile
 Swedish National Road Administration
 Volvo Cars Corporation
 Volvo Trucks
 Volvo Technology
 VINNOVA

References

- 1 B. E. SABEY, G. C. STAUGHTON: "Interacting roles of road environment, vehicle and road use in accidents", paper presented to the 5th International Conference of the International Association of Accidents and Traffic Medicine, London, 1-5 September, 1975
- 2 B. E. SABEY, H. TAYLOR: The known risk we run: the highway, Department of the Environment/Transport, Transport and Road Research Laboratory, Supplementary Report 567, 1980
- 3 R. TREAT, N. S. TUMBAS, S. T. McDONALD, D. SHINAR, R. D. HUME, R. E. MAYER, R. L. STANSIFER, N. J. CASTELLAN: Tri-level study of the causes of traffic accidents, Bloomington, Indiana University, 1977
- 4 I. D. BROWN: "Drivers' margins of safety considered as a focus for research on error", *Ergonomics*, Vol. 33, No. 10/11, pp. 1307-1314, 1990
- 5 D. FLEURY, Y. GIRARD, D. OTTE, A. ENGLUND, H. E. PETTERSSON: In-depth investigation FERSI group report, February, 1994
- 6 E. HOLLNAGEL, D. D. WOODS: "Cognitive Systems Engineering: New wine in new bottles", *International Journal of Man-Machine Studies*, 18, 583-600, 1983
- 7 E. HOLLNAGEL: Anticipating failures: What should predictions be about? In the proceeding of the Human Factors and Medicine Panel (HFM) Workshop, Siena, Italy, 1-2 December 1999
- 8 J. T. REASON: The identification of latent organizational failures in complex systems. In: J. A. WISE, V. D. HOPKIN and P. STAGER (eds.), *Verification and validation of complex systems: Human Factors issues*. Berlin: Springer Verlag, 1992
- 9 H. W. KRUYSSSE: Conditions for safe traffic behaviour, Leiden: Leiden University, 1993
- 10 J. GROENEWEG: Controlling the controllable: the management of safety, 4th revised ed., Leiden: DSWO Press, 1998
- 11 M. LJUNG: DREAM - Driving Reliability and Error Analysis Method (M. Sc. thesis), Linköping, Linköping University, 2002
- 12 E. HOLLNAGEL: Cognitive reliability and error analysis method, CREAM, Oxford, Elsevier Science, 1998
- 13 Vagtrafikskador 2001, Stockholm, SIKa, Statistiska centralbyran, 2001
- 14 Statistics of road traffic accidents in European and North America, Geneva, Economic Commission for Europe, 2001
- 15 European Accident Causation Survey (ACEA), Brussels, European Association of Car Manufactures, 2000
- 16 J. F. GUBRIUM, J. A. HOLSTEIN: Handbook of interview research: context and method, California, Thousand Oaks, 2002
- 17 PC-CRASH: A Simulation Program for Vehicle Accidents, Operating Manual, Version 7.1, Dr. Steffan Datentechnik, Linz, November, 2003
- 18 Collision Suite: Operating Manual, Third Revision, AI Training Services Ltd, UK, December, 2003
- 19 W. A. WAGENAAR, J. T. REASON: "Types and tokens in road accident causation", *Ergonomics*, Vol. 33, No. 10/11, pp. 1365-1375, 1990

B. Fildes, J. Charlton
Monash University Accident Research Centre,
Melbourne, Australia

Older Drivers and Possibilities for Injury Avoidance

Abstract

This paper set out to examine the possibilities for injury avoidance implications for older drivers in crashes, based on crash and injury patterns among older drivers and current trends in ageing in most western societies. A number of safety technologies were identified and discussed which have potential for improving vehicle older driver crash avoidance and crashworthiness. While there were some promising estimates available of the likely benefits of this technology for improving safety, it is evident that they need to be confirmed for older drivers, given their age-related disabilities and sensory limitations. Further research is urgently required to ensure that these technologies yield safety benefits without any disbenefits for older drivers.

Introduction

As the western world ages, there is an ever-increasing interest in older driver safety. Population estimates for most of the developed countries show that by 2030, one in every four people will be aged over 65 years and by 2050, experts predict a tripling of those aged 80 or more (OECD, 2001). This report notes that the baby boom generation will live longer, be more active and lead much healthier lives than their parents, thereby adding to their longevity.

Mobility is critical for older people. Studies in the USA point to the fact that many older people stop walking before they stop driving (EBERHARD, 1996), hence, the car becomes their primary means of getting around. The ability to get about freely is important in terms of maintaining their health and preventing the onset of health problems (MAROTOLLI et al., 2000; STUTTS et al., 2001) such as depression (FONDA et al., 2001). To be an active and contributing member of society, one has to remain mobile. Furthermore, stopping driving has been associated with needing greater levels of dependence, often requiring re-accommodation

and assisted care and early death (CHIRIKOS & NESTEL, 1985).

Fatality ratios (the risk of an injury being fatal) by age group increase with age is shown in figure 1 below. UK figures show that drivers aged 20 have a "fragility index" of around 1 rising three to four fold for drivers aged 80 or more (MITCHELL, 2000). The increase is even more marked for pedestrians. Similar results are reported also among US drivers and pedestrians (EVANS, 1991).

While older drivers crash numbers tend to be relatively small today, they are over-represented in terms of serious injuries mainly because of their increased frailty. HAUER (1988) reported that the over-representation of older drivers in severe crashes was not necessarily a function of their increased likelihood of having a crash so much as their increased liability of being injured or killed, due to the disability associated with ageing. Frailty or reduced biomechanical tolerance to injury is a normal part of ageing. EVANS (1991) claimed that males are 2.3 percent more likely to die in the same severity crash for each year above 20, while for females this rises by 2.0 percent.

Given the greying of western society, though, it is inevitable that crashes involving older road users will become more frequent in the coming years. Researchers in the USA and Australia have attempted to predict what this increase is likely to be taking into account what influences older drivers' decisions to continue to drive, and attempting to predict and understand future economic and related developments that are likely to alter historical trends in driver behaviour. Their estimates predict that the older driver safety problem will triple over the next 30 years without active intervention (HU et al., 2000; FILDES et al.,

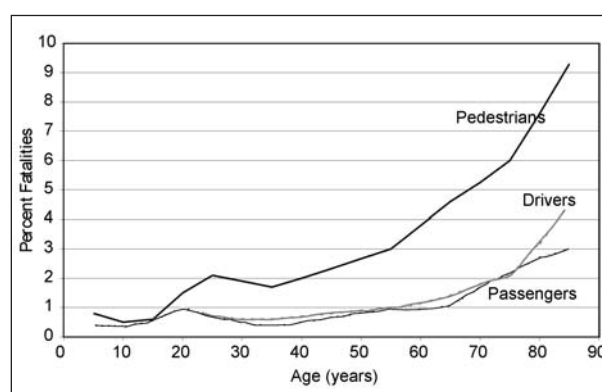

Fig. 1: Fatalities per all injuries by age and mode of travel (MITCHELL, 2000)

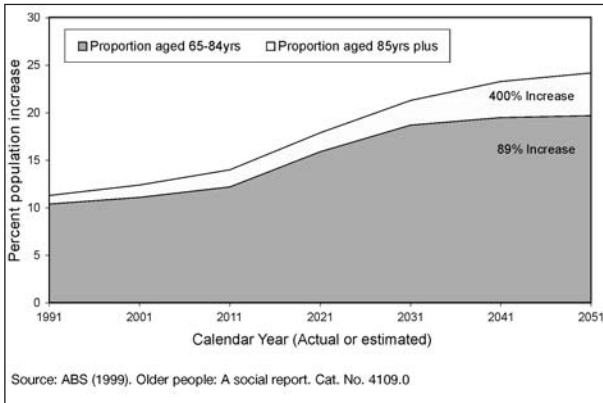

Fig. 2: Projected proportions of 65–84 year old adults and 85+ year old adults in the Australian population, 2001–2051

2001). Moreover, the biggest increase is likely to be for those aged 85 years or more.

Injuries to Older Drivers

As noted above, older drivers are much more likely to be seriously injured or killed in a collision than younger drivers because of their increased frailty. WANG et al., (1999) reported that older car occupants, 60 years and older, are twice as likely to die in a car crash, as are their younger counterparts. They also noted from their in-depth data that 86% of older occupants died from serious chest trauma and only 38% died from major head injuries (some may have died from both these injuries). They noted that 40% of those who died of a chest injury had suffered no more serious injuries than broken ribs. This is quite different for younger people where head injury is the predominant cause of death (WANG et al., 1999). They noted that seat-belts were less protective for chest injuries among the elderly.

An analysis of in-depth data collected at MUARC for predominantly survivors confirmed many of these findings. As shown in figures 3 and 4, in both frontal and side impacts after controlling for crash severity, occupants aged 65 years and above were more likely to sustain an MAIS 3+ injury than younger adults. Moreover, figure 5 shows that older occupants in side impacts were more likely to sustain a major chest injury than younger occupants and than head injuries.

MELVIN (2001) reported seat belt load tolerances by age group as shown in figure 6. He noted that those aged 36 to 65 years had only 47% of the tolerance of 16 to 35 year olds compared to only

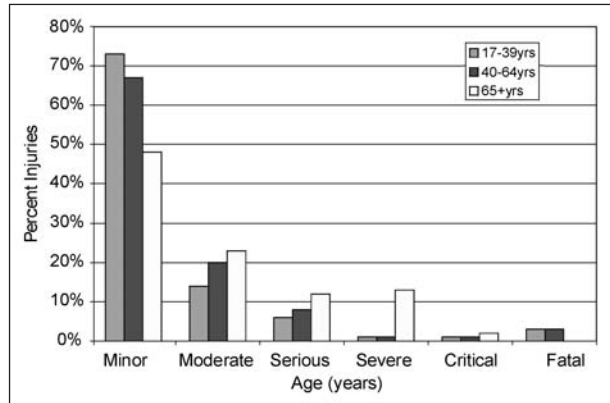

Fig. 3: Injury outcome by age – frontal crashes

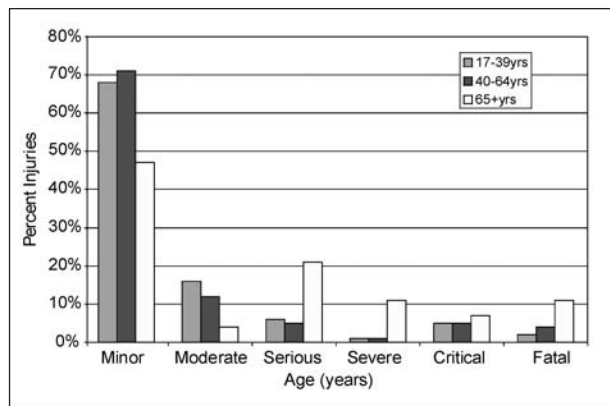

Fig. 4: Injury outcome by age – side impacts

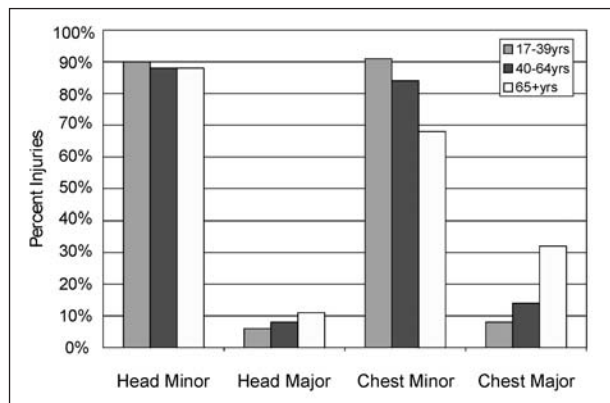

Fig. 5: Injury outcome by age – side impacts

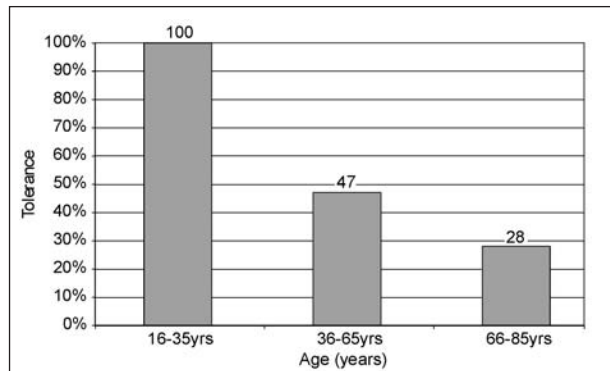

Fig. 6: Belt load tolerance (MELVIN 2001)

28% for those aged 65 years and above. PADMANABAN (2001) argued that belted older drivers were 40 times more likely to sustain a chest fracture in a crash than younger drivers while AUGENSTEIN (2001) also argued that older occupants were more likely to suffer a serious internal chest injury and have a higher rate of complication.

Older Driver Safety Intervention

In the light of all this evidence, it is clear that we need to be considering now what can be done to minimise this impending road safety problem involving older people. OECD (2001) lists a number of areas that have potential for addressing older driver safety, including improved infrastructure, licensing, better land use and education, publicity and training. Of particular interest, here though is what are the opportunities for reductions in fatalities and serious injuries through crash avoidance strategies and technology and improved crashworthiness.

Crashworthiness Options

Vehicle Age

Vehicle crashworthiness in Australia was seen to have doubled between 1970 and 1995 as shown in figure 7 by NEWSTEAD, CAMERON and LE (1997). For crashes that occurred during the early 1990s, they showed that the probability of a driver sustaining a severe injury in a crash fell from 5% to a little over 2% for different aged vehicles. They attributed this to the introduction of design regulations during the early 1970s and further improvements more recently from the introduction of consumer tests and greater consumer awareness of safety, forcing manufacturers to improve the crashworthiness performance. This has been achieved through better management of impact energy and safety technology in recent models.

One option, therefore to improve older drivers' and passengers' safety in a crash is to ensure they are in a superior crashworthy vehicle. From these figures, it is apparent that a more recent car (with improved safety technology such as airbags and better safety belt systems) offers increased potential for them to avoid severe injuries in a crash.

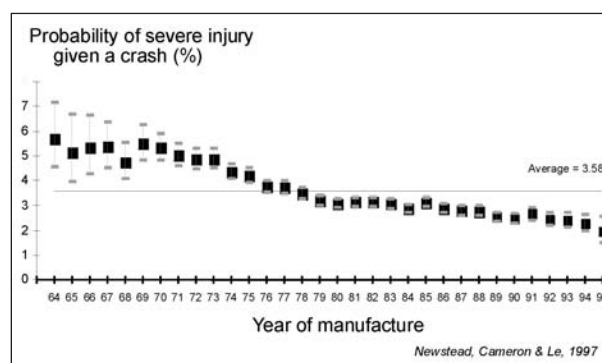

Fig. 7: Vehicle Crashworthiness by age of the vehicle, 1964 to 1995, Australia

Vehicle Mass

Newtonian physics dictates that impact force in a crash is a function of a vehicles' travel speed (squared), its mass and the mass of other vehicles it strikes. Occupants in a vehicle with a mass of 800kgm that hits another head-on at the same travel speed but with a mass of 1600kgm will experience twice the impact force than those in the heavier vehicle, all things being equal. While safety technology will help to improve the vehicle's crashworthiness, there is no getting away from the benefits of increased vehicle mass in a crash.

Another solution, therefore, to improve the risk of serious injury in a crash for older people is to travel in the heaviest vehicle they can handle and afford. Obviously, this has other implications in terms of environmental effects, price, ease of driving and difficulties in manoeuvring and parking that one needs to consider also. Nevertheless, there is no escaping the mass effect when involved in a crash (EVANS, 1991).

Safety Technology

Perhaps the greatest safety improvement in crashworthiness came with the introduction of seat-belts in cars during the 1970s. Countries such as Sweden and Australia were the first to embrace this technology and occupants have reaped the rewards ever since. Seat-belt wearing rates over 90% are commonplace in many parts of Europe and Australia today. EVANS (1991) argued that a lap/shoulder belt reduces the risk of serious injury to a driver in a crash by 41% and 46% in conjunction with a driver airbag. Even greater benefits would result from ensuring the seat-belt is aligned properly with the occupant's shoulder and hips to ensure maximum load carrying capacity and is fitted with a seat-belt retractor.



Fig. 8: Properly fitting seat-belt



Fig. 9: Seat-belt pre-tensioner

Crash Phase	ITS Technology
Pre-crash phase	Speed alerting and active limiting systems Adaptive cruise controls Vision enhancement Forward collision warning and avoidance systems Rear collision warning and avoidance systems Lane change warning and avoidance systems Lane departure warning systems Driver vigilance monitoring systems
Crash phase	Seat-belt reminder systems Intelligent restraint systems Airbags and head protection devices
Post-crash phase	Emergency mayday systems
Exposure reduction	Route navigation systems Electronic driving licenses Alcohol detection and interlock systems

Tab. 1: Technologies available or near release to avoid crashes and injuries (REGAN et al., 2001)

Even when properly fitted, the seat-belt does cause injury to frail bodies where sternum and rib fractures often occur in older occupants from the seat-belt in a crash and these have been shown to result in life-threatening injury (WANG, cited in ALONZO-ZALDIVAR, 2000). One way of decreasing the belt load has been through the fitment of airbags. (FILDES, DEERY and VULCAN, 1997) demonstrated a 17% reduction in all chest injuries and more than 100% reduction for severe chest injures for drivers of cars fitted with airbags over those without.

The supplementary airbag itself has also been shown to provide good benefits for drivers of cars in a crash from studies in Europe and Australia (FILDES et al., 1996; HUERE et al., 2001; ROSELT et al., 2002). Benefits in reduced harm of 60% were reported among drivers by MORRIS et al. (2001) for airbag fitted vehicles while KIRK et al. (2002) reported 33% reductions in AIS 3+ injuries among belted occupants in airbag-deployed vehicles in frontal crashes.

Crash Aavoidance

Advanced technology to assist drivers avoid crashes has rapidly developed over the last 10 years or so. This technology has focused on information displays, communication, sensing and control devices to assist the driver in adverse driving situations. In addition, systems to alert rescue services are currently being trialed in the USA and Australia to ensure rapid transport to hospital in life-threatening situations. REGAN et al. (2001) outlined a number of options for ITS in-vehicle technologies aimed at crash avoidance as shown in table 1. A number of the more promising systems for improving older driver performance are discussed in more detail below.

ITS Technologies Potential Useful for Older Drivers

Intelligent Speed Adaptation

These devices are aimed at preventing or minimising excursions in travel speed above the posted speed limit. They range from installations that apply positive pressure to the accelerator pedal when travel speed exceeds the posted limit to active interventions (interlocks) that prevent the vehicle travelling above a threshold tolerance. They can involve sophisticated active monitoring of the speed limit through a Global Positioning System

(GPS) to a simpler absolute upper threshold on travel speed. There have been one or two examples of GPS type systems trialed in Europe.

- The ISA Tillburg trial in The Netherlands during 2000 (Ministerie van Verkeer en Waterstaat, 1999) sought to examine whether intelligent speed adaptation is an applicable option as an instrument for speed control. A GPS system was used for monitoring vehicle speed and speed limit deviations were controlled using 3-response variants – advice only, positive throttle pressure, and active intervention through the fuel system. The trial was due to run until October 2000. Because of the limited number of people tested (120 drivers) it was not possible to assess crash savings. However, initial acceptance of 55% among those surveyed rose to 69% after the test and as high as 80% when exposed to additional information (BUSSTRA, 2001).
- The Vision Zero demonstration trials in Sweden had several vehicles fitted out with GPS and positive throttle pressure systems to demonstrate how such a system might work. The cars were donated by SAAB and used to illustrate to their drivers the way in which an interactive speed adaptation system could work and the benefits for the community in such a system. To the authors' knowledge, this system was never formally evaluated in terms of process or outcome, although anecdotally there have been a number of very positive responses by those who drove the on-road course near Trollhätten. In particular, the fact that vehicle

speed could not exceed the speed limit without active intervention was observed to have positive benefits by some in not needing to monitor the vehicle speedometer so much and hence keeping the driver's eye on the road ahead much longer.

While these systems offer some promise in reducing travel speed and hence crash involvement (and minimising injury outcome), it is understood that no manufacturer has actually introduced such a system in their vehicles, even though the GPS technology is available. It is likely that the introduction of intelligent speed adaptive systems will need to be regulated if they are to become mandatory features in cars of the future.

Forward Collision Warning

These systems are designed to detect an imminent danger of collision ahead and to either warn the driver accordingly or intervene to correct the situation where possible, as shown in figure 10. The Delphi Automotive System FOREWARN and the Eaton Vorad EVT-300 system are examples of FCW systems currently available on the market. They use microwave and Doppler radar sensors to assess an imminent threat and issue visual (and audible) warnings to the driver. REGAN et al. (2001) reported that Jaguar first offered the FOREWARN system on its XKR luxury model in 1999, however, it is not known if the system is now offered on any other models or brands and whether it has been evaluated using data collected in the field, especially for older drivers.



Fig. 10: Forward Collision Warning

Emergency Mayday Systems

Figure 11 shows an example of an emergency mayday early notification system. The system is designed to identify if a crash has occurred in the

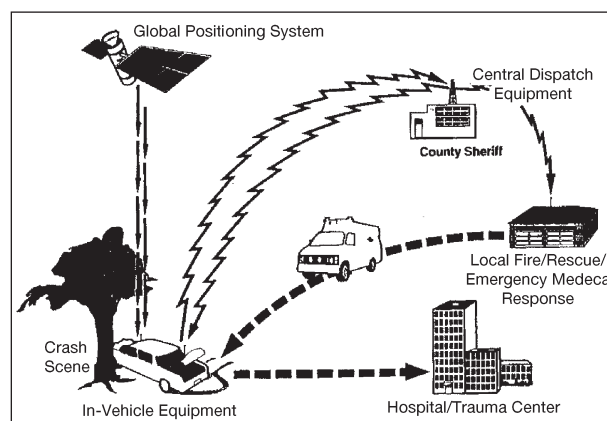

Fig. 11: Emergency mayday system

target vehicle, the location of the crash and whether anyone was seriously injured (via a telephone call to an in-built mobile phone). Data would also be collected on pre-crash information (travel speed, brake status and throttle opening) and crash data (peak crash pulse, seat-belt status and airbag deployment) and transmitted to a central monitoring station. When warranted, emergency services would be initiated and an appropriate destination hospital or trauma centre would be notified.

CHAMPION et al. (1998) argued that an Automatic Notification System (ACN) would have a major influence on reducing EMS response times as well as provide a mechanism whereby treating hospitals could get early notification during transport of an injured patient and hence provide more accurate matching of available local resources with patient needs. They noted three systems in operation in the USA; the RESCU system onboard at least luxury Ford vehicles, the GM ONSTAR system fitted to GM luxury models and the NHTSA/Calspan technology system in Buffalo, under evaluation by the Erie County Medical Center.

DIGGES (2001) described an algorithm (URGENCY) for converting data from onboard crash recorders to assist in identifying crashes that are most likely to have time-critical injuries. The algorithm involved a prediction of the probability of severe injury based on impact severity, car curb weight, airbag and seat-belt deployment, occupant age and sex. Of particular relevance to this paper, he noted an inverse relationship between age and injury risk for equivalent crash severity as shown in figure 12. The algorithm is currently under evaluation but they claim that it, in conjunction with an ACN system had the potential to reduce crashes by around 25%, a figure close to that reported by BRODSKY (1983) who predicted a likely 20% reduction in highway crash injuries generally with better EMS and up to 38% in some rural locations. He claimed that with automatic life saving technologies fully deployed, this would amount to approximately 10,000 deaths saved each year (27 deaths each day) in the USA.

Vision Enhancement

figure 13 shows an enhanced visual image system where night-time views of the road ahead are enhanced through infrared technology and

displayed onto the windscreen to provide drivers with advanced warning of hazards ahead. It is considered to be especially beneficial for nighttime driving and in adverse weather conditions. We are aware that the up-market Mercedes Benz, Jaguar and Cadillac vehicles offer commercially available visual enhancement systems and that this is generally presented to the driver in a head-up display projected onto the windscreen of the vehicle. Little information is known about their likely effectiveness and the disbenefits of head-up-displays have also been alluded to by some authors (eg; WARD & PARKS, 1994; BOSSI et al., 1997). GONDAK (1996) claimed that as much as 43 percent of all crashes (and 31 percent of fatal crashes) occurred during inclement and night-time visual conditions and it would be expected that crashes at these times is where the safety benefits from enhanced visual image systems would come from.

Fatigue Monitoring

Older drivers are more likely to tire more quickly than their younger counterparts hence monitoring their level of fatigue and intervening has potential

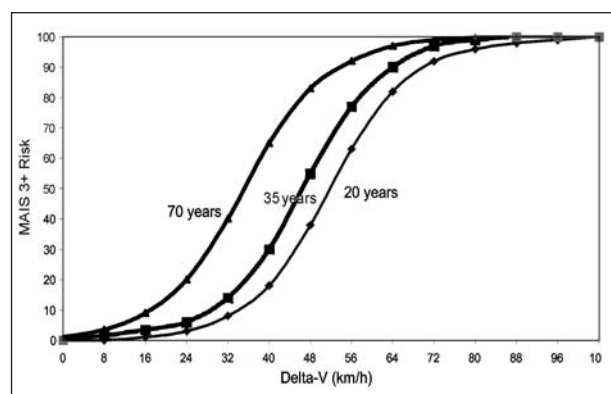

Fig. 12: Risk of MAIS 3+ by impact severity and driver age (DIGGES, 2001)



Fig. 13: Enhanced visual image system

road safety benefits. Fatigue monitors have the added bonus of also detecting other performance impairments, such as drink-driving and drug abuse. Drowsiness can be detected by systems that analyse behaviour including rapid acceleration (and deceleration) erratic braking and gear changing, excessive lane changes and inappropriate headway (REGAN et al., 2001).

A few fatigue-monitoring systems are presently available. REGAN et al. (2001) note that Mack Trucks in the USA employ a system called 'Safetrac' which monitors lane deviations and driver vigilance, while Toyota's and Mitsubishi's 'Advanced Safety Vehicles' incorporate a drowsiness warning system, monitoring performance through driver behaviour and steering control. HARTLEY et al. (2000) argued that the main problems with these systems are their effectiveness and their reliability. Nevertheless, LIND (1997, cited in RUMAR et al., 1999) estimated that with high implementation among vehicle fleets, a driver monitoring system could reduce injury crashes by 20 percent, in particular, among single-vehicle accidents.

Lane Departure Warning

The final crash avoidance system to be considered for improving older driver safety is in providing warnings of lane departures. Older people generally experience difficulty with complex manoeuvres on the road and have restricted head

movements. Consequently, they tend to wander more on roads and lane excursions are more likely.

It is hypothesised that lane departure warnings (and improved mirror systems) would be of benefit to older drivers in ensuring they stay within their travel lane. However, lane departure warning systems that are commercially available tend to be relatively immature and unreliable (REGAN et al., 2001) and there is none that we are aware of that is fitted to current model vehicles. Hence, their effectiveness is unknown. REGAN et al. (2001) claimed that they would likely be effective for rural single-vehicle crashes and sideswipes with only a relatively small 5% reduction on all crashes.

Benefits of Technologies for Older Drivers

The likely estimated benefits from these technologies were reported by REGAN and his colleagues from various publications and estimates and are summarised in table 2 below.

These benefits are for all drivers of all ages and it's not sure how effective (or acceptable) they are likely to be among older people. One of the consequences of ageing is a reduced cognitive capacity as the number of brain cells diminishes and an increase in mental disorders such as dementia and Alzheimer and Parkinson diseases occurs. Consequently, they find it difficult to multi-

System	Description	Crash Scenarios	Estimated Benefit
Intelligent speed monitor	Limit speed to posted speed limit	Single-vehicle, head-on, same direction, intersection and pedestrian crashes	20% effectiveness 10.8% reduction
Forward Collision Warn.	Warns of imminent collision danger	All rear-end and same direction crashes	7% reduction
Lane Departure Warning	Warns when deviating from travel lane	Rural single-vehicle, off-path and side swipes	50% effectiveness 5.2% reduction
Fatigue Monitor	Detects impairment due to fatigue, etc.	Single-vehicle crashes	50% effectiveness 4.3% reduction
Mayday system	Automatic notification of crash involvement	All crash types	0% reduction crashes (BRODSKY, 1983) 20% to 38% injury savings
Electronic drivers licence	Prevents unlicensed driving and adjust vehicle	All crashes involving unlicensed drivers	Unknown effectiveness (97.6% expected reduction of unlicensed)
Vision enhancement	Provides an enhanced vision of danger ahead	Single-vehicle, head-on, same direction, intersection and pedestrian crashes	Unknown effectiveness (43% of crashes occur in inclement or night-time visual conditions)

Tab. 2: Summary of the benefits of ITS technologies (REGAN et al., 2001)

task and are easily distracted and confused by competing sources of information. Their vision and hearing also deteriorate and they tend to be less technically skilled.

It is fair then to question their likely effectiveness for older drivers. As part of the European DRIVE II EDDIT project, OXLEY (1996) exposed older drivers to six ITS technologies, generally considered most likely to be beneficial for older drivers. He found that visual enhancement and mayday systems were likely to improve older driver mobility and safety but that collision warning systems and reversing aides would have little impact on improving older driver mobility and safety. He further noted that older drivers preferred auditory instructions in addition to visual displays for both route navigation and rear collision warning systems.

Intersections and complex turning manoeuvres feature predominantly among older driver crashes (FILDES et al., 1994; OXLEY, 2000; ANDREA et al., 2001). They noted that making judgements about when it is safe to cross in front of turning traffic is difficult for older drivers and pedestrians alike as the ability to judge safe gaps deteriorates with age. While poor vision plays a role in this, so too does their primary reliance on distance away without due consideration about approaching speed. Technology to aid this decision would seem to be paramount to enhance older driver safety. A simple exposure-reduction solution for addressing this was proposed by SPARKE (2002) when he argued for pre-route planning to maximise left-hand turns¹ over right-hand ones for journeys in busy urban areas.

Human Factors Research

While many of the technologies reported here do offer promise for reducing older driver crashes, it is clear that they need to be evaluated on road or road-like driving environments. This is particularly the case as many of these ITS devices have not been developed or tested for vulnerable road users (REGAN et al., 2001). This is an area of urgent research for the future to ensure that the current avalanche of new safety technology is optimal for

the road users it is supposedly targeted to be of benefit for. This research needs to encompass analytical studies focussing on the most effective human-machine interface and examining the behavioural consequences of such technologies, separately as well as in conjunction with each other. In particular, the research needs to examine the consequences of technology for differing age and sex groups as well as other vulnerable members of society who are regular road users. Without such research, we are likely to be overrun with a smorgasbord of new safety developments that may well have unforeseen safety disbenefits.

Conclusions

This paper examined the injury implications for older drivers in crashes and trends in ageing of western societies. The need for improvements in older driver safety is plainly evident from this analysis. A number of safety technologies were identified and discussed which have potential for improving vehicle older driver crash avoidance and crashworthiness. While there were some promising estimates available of the likely benefits of this technology for improving safety, it is evident that they need to be confirmed for older drivers, given their age-related disabilities and sensory limitations. Further research is urgently required to ensure that these technologies yield safety benefits without any disbenefits for older drivers.

References

- ANDREA, D. J., FILDES, B. N., & TRIGGS, T. J. (2001): The Sensitivity and Bias of Older and Younger Driver Judgements in Complex Traffic Environments. Road Safety Research, Policing & Enforcement Conference, Melbourne, Australia
- ALONZO-ZALDIVAR, R. (2000): Auto Makers Retool to Fit an Aging U.S. Safety: Study puts focus on protecting the growing population of older drivers. Industry re-examines testing, LA Times article, Monday, July 31, 2000
- AUGENSTEIN, J. (2001): Differences in clinical response between the young and the elderly. Paper presented at the Aging and Driving Symposium, Association for the Advancement of Automotive Medicine, Des Plaines, IL, February 19-20, 2001

¹ Cars in Australia drive on the left-hand side of the road, hence turning across a traffic stream involves a right-hand turn manoeuvre.

- BOSS, I. L., WARD, N., PARKES, A. & HOWARTH, P. (1997): The effect of visual enhancement systems on driver peripheral visual performance, in NOY, Y. (ed). *Driver Fatigue: An Experimental Investigation*, Mahwah, New Jersey
- BUSSTRA, J. (2001): Government Status Report from The Netherlands: Exploring the role of telematics in road safety, a Dutch perspective, Proceedings of the Enhanced Safety of Vehicles conference, National Highway Traffic Safety Administration, The Netherlands
- CHAMPION, H., R., AUGENSTEIN, J. S., CUSHING, B., DIGGES, K. H., HUNT, R., LARKIN, R., MALLIARIS, A. C., SACCO, W. J. & SIEGAL, J. H. (1998): Automatic Crash Notification, *J. AirMed*, March/April, 1998
- CHIRIKOS, T., & NESTEL, G. (1985): Longitudinal analysis of functional disabilities in older men. *J. Gerontology*, 40 (4), 426-433
- DIGGES, K. (2001): The URGENCY Algorithm – A Thermometer for Trauma, Proceedings of the VDI conference in Berlin, Sep 8, 2001.
- EBERHARD, J. (1996): Safe Mobility of Senior Citizens. *Journal of International Association of Traffic and Safety Sciences*, 20 (1), 29-37
- EVANS, L. (1991): *Traffic Safety and the Driver*. Van Nostrand Reinhold, New York
- FILDES, B. N., CORBEN, B., KENT, S., OXLEY, J., LE, T., & RYAN, P. (1994): Older Road User Crashes. Driver, Pedestrian, Elderly, Injury, Crash Trends, Crash Characteristics, Road Trauma Costs, Countermeasures. Report No. 61, Monash University Accident Research Centre, Melbourne, Australia
- FILDES, B. N., DEERY, H., LENARD, J., KENNY, D., EDWARDS-COGHILL & JACONSEN, S. (1996): Airbag experience in Australia, Proceedings of the Enhanced Safety of Vehicles conference, National Highway Traffic Safety Administration, Melbourne, Australia
- FILDES, B. N., DEERY, H. & VULCAN, A. P. (1997): Effectiveness of airbags in reducing seatbelt injuries, Proceedings of the International Research Conference on the Biomechanics of Injury (IRCOBI), September 24-26, 1997 in Hannover, Germany
- FILDES, B. N., FITZHARRS, M., CHARLTON, J. & PRONK, N. (2001): Older driver safety – A challenge for Sweden's 'Vision Zero', Proceedings of the Australian Transport Research Forum, Department of Infrastructure, Energy and Resources, Hobart, Australia
- FONDA, S., WALLACE, R., & HERZOG, R. (2001): Changes in driving patterns and worsening depressive symptoms among older adults. *Journal of Gerontology*, 56B (6), S 343-S351
- GONDAK, J. (1995): Vision enhancement for crash avoidance, Georgia Institute of Technology, School of Civil & Environmental Engineering Course Materials <http://traffic.ce.gatech.edu/ce8103/userserv/user23.htm>
- HARTLEY, L., HORBERRY, T., MABBOTT, N. & KRUEGER, G. (2000): Review of fatigue detection and prediction technologies, Paper prepared for the National Road Transport Commission, Melbourne, Australia
- HAUER, E. (1988): The safety of older persons at intersections, *Transport in an Ageing Society*, Special Report 218, Vol 2, Transportation Research Board, National Research Council, Washington DC
- HU, P., JONES, D., REUSCHER, T., SCHMOYER, R. & TRUETT, T. (2000): Projecting fatalities in crashes involving older drivers, Report for the National Highway Traffic Safety Administration, Oak Ridge National Laboratory Tennessee: ONRL
- HUERE, J. F., FORET-BRUNO, J. Y., FAVERJON, G. & LE COZ, J. Y. (2001): Airbag efficiency in frontal real world accidents, Proceedings of the Enhanced Safety of Vehicles conference, National Highway Traffic Safety Administration, The Netherlands
- KIRK, A., FRAMPTON, R. & THOMAS, P. (2002): An evaluation of airbag benefits/disbenefits in European vehicles – A combined statistical and case study approach, Proceedings of the International Research Conference on the Biomechanics of Injury (IRCOBI), Munich, Germany
- MAROTTLLOI, R., MENDES de LEON, C., GLASS, T., WILLIAMS, C., COONEY, L., & BERKMAN, L. (2000): Consequences of driving cessation: Decreased out-of-home activity levels. *Journal of Gerontology*, 55B (6), S 334-S340

- MELVIN, J. (2001): An overview of tissue tolerance in the elderly, Proceedings of the Presentation at Aging and Driving Symposium, Southfield, MI, 19-20 February 2001. Association for the Advancement of Automotive Medicine, Des Plaines, IL
- Ministerie van Verkeer en Waterstaat (1999): ISA Tilburg: Intelligent Speed Adaptation in Practice, Ministry of Transport, Public Works and Water Management, Province of Noord-Brabant, City of Tillburg. The Netherlands
- MITCHELL, C. G. B. (2000): Some implications for road safety of an ageing population, Transport Trends, Department of the Environment, Transport and the Regions, The Stationary Office, London
- MORRIS, A., BARNES, J. & FILDES, B. (2001): The effectiveness of airbags in Australia as determined by in-depth crash injury research, Proceedings of the Enhanced Safety of Vehicles conference, National Highway Traffic Safety Administration, The Netherlands
- NEWSTEAD, S., CAMERON, M. & Le, T. (1997): Vehicle crashworthiness ratings: Victoria 1983-95, and New South Wales 1989-95 crashes. Technical Report, Monash University Accident Research Centre, Clayton
- OECD (2001): Ageing and Transport: Mobility Needs and Safety Issues, Organisation for Economic Co-operation and Development, Paris, France
- OXLEY, P. (1996): Elderly drivers and safety when using IT systems, IATSS Research, 20 (1), 102-110
- OXLEY, J. (2000): Age Differences in Road Crossing Behaviour, Unpublished PhD Thesis, Monash University, Clayton, Australia
- PADMANABAN, J. (2001): Crash injury experience of elderly drivers, Proceedings of the Presentation at Aging and Driving Symposium, Southfield, MI, 19-20 February 2001. Association for the Advancement of Automotive Medicine, Des Plaines, IL
- REGAN, M., OXLEY, J., GODLEY, S. & TINGVALL, C. (2001): Intelligent Transport Systems: Safety and Human Factors Issues, Report 01/01, Royal Automobile Club of Victoria, Melbourne, Australia
- ROSELT, T., LANGWIEDER, K., HUMMEL, T. & KÖSTER, H. J. (2002): Injury patterns of front seat occupants in frontal car collisions with airbags: Effectivity and optimisation potential of airbags, Proceedings of the International Research Conference on the Biomechanics of Injury (IRCOBI), Munich, Germany
- RUMAR, K., FLEURY, D., KILDEBORGGAARD, J., LIND, G., MAURO, V., BERRY, J., CARSTEN, O., HEIJER, T., KULMALA, R., MACHATA, K. & ZACKOR, I. (1999): Intelligent Transportation Systems and Road Safety, Report prepared for the European Transport Council, Brussels
- SPARKE, L. (2002): Fleet safety, Paper presented at the 2002 Road Safety and Education Conference, Adelaide, Australia
- STUTTS, J., WILKINS, J., REINFURT, D., RODGMAN, E., & Van HEUSEN-CAUSEY, A. (2001): The premature reduction and cessation of driving by older men and women (No. Project G.7, Final report): Chapel Hill, NC: Highway Safety Center, University of North Carolina
- WANG, J. S., KNIPLING, R. R. & BLINCOE, L. J. (1999): The dimensions of motor vehicle crash risk, J. Transportation and Statistics, 2 (1), 19-43

**Session: Accident Prevention and Causation –
Part II**

B. Pund, D. Otte

J. Lenard, J. Hill

Y. Page, S. Cuny

B. Pund
Medical Psychological Institute, Hannover, Germany

D. Otte
Hannover Medical School, Germany

Assessment of Accident Causation from the Viewpoint of In-Depth Investigation on Scene – Traffic Psychological Methodology on Examples of In-Depth Cases by GIDAS

Abstract

This contribution introduces a number of psychological methods of analysis that are based on the practice-oriented collection of information directly at the site of an accident and that allow for an analysis and coding of the accident causes. Investigation examples and examples of the data combinations with basic medical and technical data are outlined.

Objective of the collection is the inter-disciplinary investigation of human factors in the causes of accidents (“human-factor-analysis“). The psychological data are incorporated according to an integrative model for accident causes based on empiric algorithms in the data base of the accident research, where the clustered evaluation potential of comprehensive factors of the accident development can be illustrated.

The central theoretical concept for the basic model of the progress of the accident from a psychological point of view comprises psychological indicators for the evaluation of the site of the accident for the analysis of the perception conditions as well as a classification of the gleaned data into the accident progress model according to chronological and local criteria. Perception conditions, action intentions and executions as well as conditions limiting perception and actions are acquired, using a questionnaire for persons involved in an accident, and are also integrated into the data structure concerning weighted feature characteristics as well as combined with other relevant features.

Suitable systematization tools for the collection and coding of psychological accident development

parameters have to be provided, which require primarily a model image of the corresponding processes from the persons involved in the accident (perceptions, expectations, decisions, actions). The interactive accident model contains components of the models by KÜTING 1990, MC DONALD 1972, SURREY 1969 and RASMUSSEN 1980. Based on the inter-action of the three partial systems “person“, “vehicle“ and “environment“, the first step is the assessment of the situation by the persons involved in the accident. This is dependent on the personal attitudes and motives, on experiences and expectations concerning the progress of the situation. Subsequently, data concerning the manner of the coping with the ambiguous state as well as with the instable state (emergency reaction immediately before the accident occurs) are collected. The factors relating to the persons involved in the accident are gathered on several levels using corresponding questionnaires. The coding of the found and collected characteristics is conducted in a multi-dimensional evaluation relating to the technical results of the accident reconstruction and of the psychological classification, which are subsequently integrated in coded form into the data base of the accident research. The result of this analysis is a description of the development of the accident depicted on a chronological vector from a perception and decision theoretical perspective. This is explained in detail using exemplary cases.

Introduction

Starting in 1973, a team of physicians and engineers at the Medical University of Hannover, Germany, has conducted accident investigations in the Hannover area according to a set sampling and investigation plan. The methodology has been internationally described (OTTE, 1994). The data collected this way refer amongst others to the determination of the driving and collision speeds and the time-distance-behavior of the road users involved. The accident causes are derived from police protocols according to the official list of causes. In order to emphasize the interdependence and the interaction of vehicle makes, environmental impact and personal features of the involved persons, in the early 90s a subgroup of investigations of accidents with personal damage was conducted using the help of a psychological interrogator of the Medical-Psychological Institute

(TÜV NORD GRUPPE Hannover). The results of the comparison of different methods of data collection based on psychological questioning of persons involved in an accident were summarized in a methodology study (PUND and NICKEL, 1994) and applied to a number of real life sample cases. This required the development of tools for the data acquisition on site, which deal with the inherent difficulties, and by the same token, interrogators, who have been well trained in traffic psychological background knowledge and traffic psychological methodology. The questioning tool that had been used up to that point in time had been a semi-standardized questionnaire that was sub-divided into nine sub-categories and which permitted the interrogator to collect in a pre-structured form the most important features and their specifications from the reports by persons involved in the accident (figure 1: questionnaire for persons involved in an accident).

Development of a Methodology Study

In the course of the application of the psychological investigation tools it turned out that the data gleaning during the psychological questioning has to be streamlined, because the questioning of persons involved in the accident and witnesses at the site of the accident has to be conducted under a lot of pressure and in parallel to the collection of medical and engineering data shortly after the accident event. This may cause the loss of relevant information. Also, the psychological assessment of the site of an accident concerning its complexity and the perception conditions of the road users turned out

- direction of movements/driving manoeuvres
- environmental features
- perception
- expectations
- danger assessment
- prevention strategy/reaction
- purpose of the drive/progress of the drive
- driving habits/driving experience
- psychological and health status

Fig. 1: Questionnaire for persons involved in an accident

to be problematical taking into account the time-critical conditions. Even if the interrogation of the persons involved in an accident is conducted at a later stage or if the analysis of the site of an accident is conducted subsequently, it has to be stated that a considerable effort has to be made, in order to acquire the data, especially considering that for a subsequent data acquisition the claim of an investigation closely related to the occurrence of the accident event would have to be given up.

Further steps of the integration of a psychologically oriented data acquisition into the tasks of the investigation teams thus refer to a reduction of the variables that have to be assembled, which should on the other hand not overshoot, in which case the informational value might be lost/disturbed. Next to the objective of increasing the efficiency of the data acquisition, the psychological questionnaire was edited concerning its relevancy towards the clarification of that part of the origins of the accident, which has to be attributed to the "human factor". This in turn required that the features catalogue had to be based on a model that follows the demands of an interactive and systemic point of view, as has been recognized for analyses of "human – machine – systems" in other areas of accident analysis.

In order to reach this goal, a model for the origins of the accident was used that takes into account the human and his interaction with the system components "vehicle" and "environment/traffic directing/traffic situation".

Development of an Accident-Sequence Model

If accident research is not conducted reductionist, i.e. restricted to the most conceivable and obvious data, it must be based on a model that is derived from a system concept. System concepts are characterized by a great degree of credibility, on the other hand they are not very vivid. This is largely due to the fact that an explicit consideration of complex correlations can only be realized using massive simplification, if the lucidity e.g. of conjunction rules of the variables is too be ensured. The objective of the project, namely to provide a systematization suitable to the investigation and coding of psychological accident origin parameters, requires primarily the model-type image of the corresponding processes of the

persons involved in the accident (perceptions, expectations, decisions, actions), the classification of the whole perception situation at the site of the accident as well as the classification of the driving tasks and tangible driving manoeuvres in the model image. Secondly, the model has to be able to depict the analysis of the conflicts immediately before the accident, also external and internal influences have to be taken into account, as they supply information concerning possible action errors. The systemic approach thus comprises features of the requirements before the accident situation as well as features of the acquisition of information, the data processing and the tangible decisions of the active persons. Basic models for the origins of accidents contain, if they are based on a systemic approach, the interacting process components “person – environment – machine“. For purposes of accident research at the site of an accident (“on the spot“) and immediately after the accident has occurred (“in time“), those models are suitable that depict the effect system with its components as a closed loop. Models such as the one by APEL (1996) for instance ask how the driver operates his vehicle and how he assimilates and processes the driving state variables, starting with the vehicle (see figure 2)

Other models on the other hand, that follow the same systemic approach, further differentiate the effect component “environment“ by emphasizing

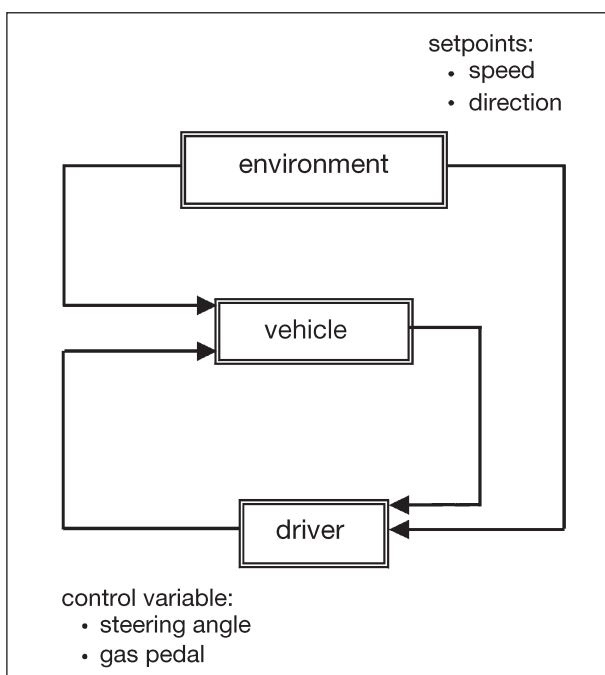

Fig. 2: Effect system driver-vehicle-environment

the interaction of the traffic situation and directing (MAREK and STEN, 1977) (figure 3).

The exemplarily depicted models of interactive effect mechanisms just like many comparable models lack a closer description of those processes, however, that are contained in the “control variable“ human and that start with him. Based on analysis methods from the area of the ergonomics, a model used for data processing is to be applied that corresponds to the so-called analysis process of the second generation. Other publications have frequently complained of the lack of a standardized process for traffic psychological questions as well as for the analysis of the task of driving that would allow for a requirement analysis, but corresponding to the action analysis in the traditional industrial psychology the individual driving tasks concerning perception, decision and actions of the human can be differentiated. In addition, the analogy of the psychological data acquisition to a model gleaned from the data processing has the advantage that especially human objectives and requirements move into the center of the consideration. The systemic data processing point of view takes into account that human behavior contains far more than the perception signals and warnings and the subsequent optimum execution of prescribed actions. A systematic set-up on this basis takes the following into account:

- the human generally has to process more than one signal simultaneously in the course of the data processing; additional interference such as weather and environmental conditions during driving constitute increased demands of the cognitive processing process;
- the human has expectations, objectives, preferences and needs; he has e.g.

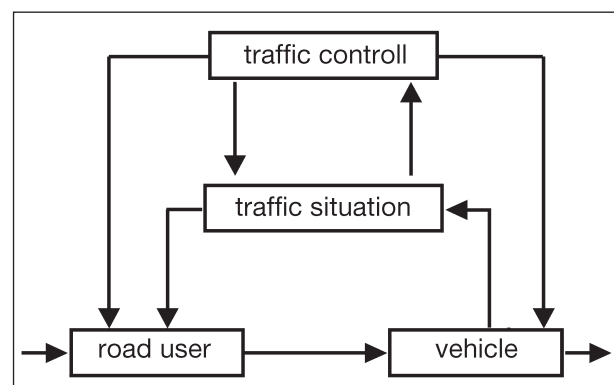

Fig. 3: Traffic system according to MAREK and STEN (1977)

expectations in the functioning of the technical system; furthermore the reaching of the destination is the primary goal of the drive.

The cognitive processing process is greatly influenced, as shown in figure 4, by the aim orientation of the human and the environment as well as the situation factors. These parameters should be part of the model on which the psychological accident research is based.

At this point it has to be emphasized that there can not be an extensive driver-model, that is also used for the description and explanation of accidents, but only driver models, that are adapted to the special requirements of an application area (HEINRICH and PORSCHE, 1989; WILLUMIT and JÜRGENSOHN, 1997). One of the main problems for the modeling of human behavior is its immense variation, flexibility and the great inter-individual differences. Also internal conditions such as objectives, requirements and motives are (within certain limits) subject to change. As there can be a number of ways to satisfy an objective or a requirement, the human behavior, even for identical external conditions, varies widely. Thus, for the purpose of psychological traffic accident research, models are preferred that can deal with the internal variations of the human behavior and simultaneously supply sorting principles for the acquisition and description of these variations. For the adaptation of the mentioned model gleaned from data processing, the model according to CROSS and FISCHER (quoted after CIER et al., 1983) is deemed suitable. Similar to the models of the functional levels by RASMUSSEN (RASMUSSEN 1980, 1981, 1995; RASMUSSEN and LIND, 1982), cognitive functions of the identification and recognition, decision and action execution are taken into account (model of the rules levels). In order to categorize perceptions, evaluation processes, decisions and actions before

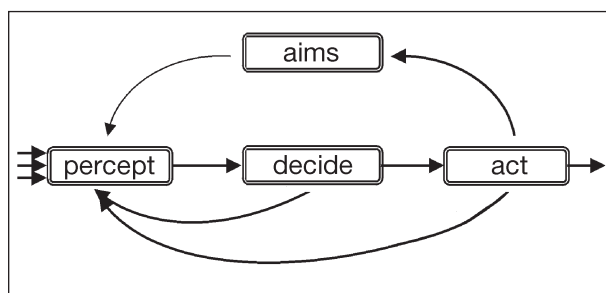

Fig. 4: Data processing model

the accident event in a sensible manner and attribute them to the accident cause explanation, a chronological acquisition, i.e. the analysis of the individual subsequent processes, becomes necessary. The model by McDONALD (1972) takes this sequential idea into account, which (roughly summarized) describes the states “normal course“, “meta-stable state“ and “instable state“ before the occurrence of the damaging event (accident). Within these individual phases the required driving tasks for the coping with the traffic situation can be found:

- perception and identification,
- interpretation and evaluation,
- decision,
- action and execution control.

Derived from these model images the model shown in figure 5 depicts the driver relevant accident sequence phases, where the chronological sequences have been integrated into the individual requirements to perceptive, decisive and executive processes.

When closely considering this model, it becomes obvious that the structural elements of the hierarchic model have been incorporated in the

phase	explanation
1. routine course	strategy and navigation; routine actions; initial states of the person (human predisposition)
2. occasion to orientate	transition from routine to orientation action in cases of ambiguous situation (search)
3. attention direction	transition from the distributed to the focused perception, activation, recognition/identification of warning signals (detection)
4. processing and evaluation*	transition from identification to interpretation, balance of the mental model with the chain of events, expectation formation, situation and risk evaluation (evaluation)
5. action plan*	assessment of alternative actions and selection of suitable actions according to cost-benefit-aspects, ability, experience and degrees of freedom (decision)
6. reactions	prevention reactions; “emergency action“, operation action, reactions and accompanying effects (operator action)
7. driving manoeuvres	resulting 3D and time-dependant driving dynamics (vehicle action)

* alternatively reflectorial/automated processes (modified according to CROSS & FISCHER quoted from CIER et al., 1983 and RASMUSSEN, 1986; model names in brackets)

Fig. 5: Driver-related accident-sequence phases

driving task: from the task of navigating to the leading level up to the stabilization level. This hierarchic model comprises the following steps (e.g. according to JANSSEN, 1979):

- navigation level (strategic level) e.g. planning the route, determination of the chronological sequences;
- leading level (level of the driving manoeuvres), where dependent on the conditions of the driving and traffic situations the determination of setpoint direction, setpoint speed and driving manoeuvres (e.g. changing lanes, overtaking) is executed;
- stabilization and control level (level of the automated or reflectorial control mechanisms), where the driver deals with deviations of the current from the setpoint values (e.g. keeping within the track) according to the ascertained feedback via vehicle and environment.

According to the accident-sequence-model the meta-stable state starts with the perception and identification of danger signals, thus in figure 5 with the transition from a routine to an orientating action in ambiguous situations (item 2). At the latest starting from the level of the driving manoeuvres (item 6) the instable state occurs with prevention reactions or an "emergency action", where according to the model of the hierarchic structure of the driving actions largely unconscious and automated action patterns are employed.

According to the hierarchic driver behavior-models of KESKINEN (1996), also features concerning motive, attitude and valuing enter into the level of strategy and navigation that influence the driver behavior. High level targets and the context of the driving become important for the investigation of psychological parameters, such as the importance of the cars and of driving for personal development, the destination of the drive, the social context of driving. Even though in publications the importance of higher level features of life style and motives are evaluated differently concerning the type of participation in traffic or the tangible driving style, "in-depth studies" for the explanation of psychological accident causes can not be completely ruled out, due to the reasons delivered above based on the systemic point of view.

After the development and the structure of the model that has been chosen as a basis, now the

influence of the individual model components on the tangible investigation contents are to be highlighted.

Derivation of a Psychological Questionnaire

The model for the psychological analysis concerning the "human" accident conditions has the following features:

1. its base is systemic-interactive,
2. it follows information and decision theoretical concepts,
3. it is set up based on the theory of actions (reliability of actions and accuracy of observations),
4. it shows the chronological sequence of the pre-crash phase.

Concerning the importance of the interactive or systemic perspective, it has to be noted that only the data combination of psychological together with medical and technical data is appropriate to this approach. Thus it is assumed that a behavior adapted to the requirements (accident prevention) derives from the interrelation between the driving task and the performance abilities of the drivers (situation x person). A psychological data acquisition thus has to ask the following questions:

- Which were the requirements in the situation? (e.g. data processing, operational actions)
- Which were the features of the traffic situation concerning the complexity of the driving task and the perception conditions?
- Which information on the danger was available?
- How were the abilities for the recognition and processing of objectively existing risks?
- Which decisions were made when?
- Was there room for actions to prevent the danger?
- Which were the external targets, specified by the driving task, and which were the internal ones?

The model described in figure 5 of the driver-related accident-sequence phases can be integrated into a comprehensive model, which also contains model images by KÜTING (1990),

SURREY (1969) and RASMUSSEN (1980, 1981, 1986) (cf. attachment 1: interactive accident model). In a simplified form, psychological questionnaires result from three states in their chronological sequence: routine situation (stable state), ambiguous situation (meta-stable state) and danger situation (instable state). An example of this (cf. attachment 2) is given in the following.

On the level of the routine situation the degree of attention e.g. of the driver of a vehicle for danger signals or a change of the situation is to be closely identified. In analogy to REASON (1990) and RASMUSSEN (1986) action errors in this context are analyzed on certain rules levels that result in a reduction of the attention. Demands on the driver besides his main task of driving can then result in distractions by external and internal stimuli, other dominant intentions and secondary tasks, which in turn can result in faulty actions (fault by omission, fault by confusion, fault by orientation). Concerning the questioning of the persons involved in an accident this means that the concrete conduct in the sense of a faulty action has to be gleaned from his information. On the next level in time, the ambiguous or the orientation situations (meta-stable state), the conduct of the participants is more closely narrowed down, for instance by asking for interpretational errors and execution plans. Here, as shown in the following example case, a "confirmation or confidence error" can be present.

Example Case

Traffic situation and driving task:

A car driver has to turn left into right-of-way street at a T-intersection (figure 6), lets pass a van turning into her street from the right, also lets pass another van approaching from the left and starts: collision in mid-intersection with a motorcycle approaching from the right side, who turns against her driving direction.

Results of the technical reconstruction:

It was determined on the basis of deformations and movement pre- and post-crash that the car hit the cycle with its front laterally at a speed of 14km/h, a time of 2.2 seconds after starting acceleration. The cyclist was driven with approximately 6km/h at moment of collision.

Results of the accident recording:

Good visibility, no restrictions by weather conditions (time of the accident app. 9 a.m. in summer on a clear day), driver wants to drive her children to school.

Results of the later interrogation (car driver):

Question concerning the perception conditions at the site of the accident:

She has driven vehicles for more than 20 years, she knew the route, "like the back of my hand". She

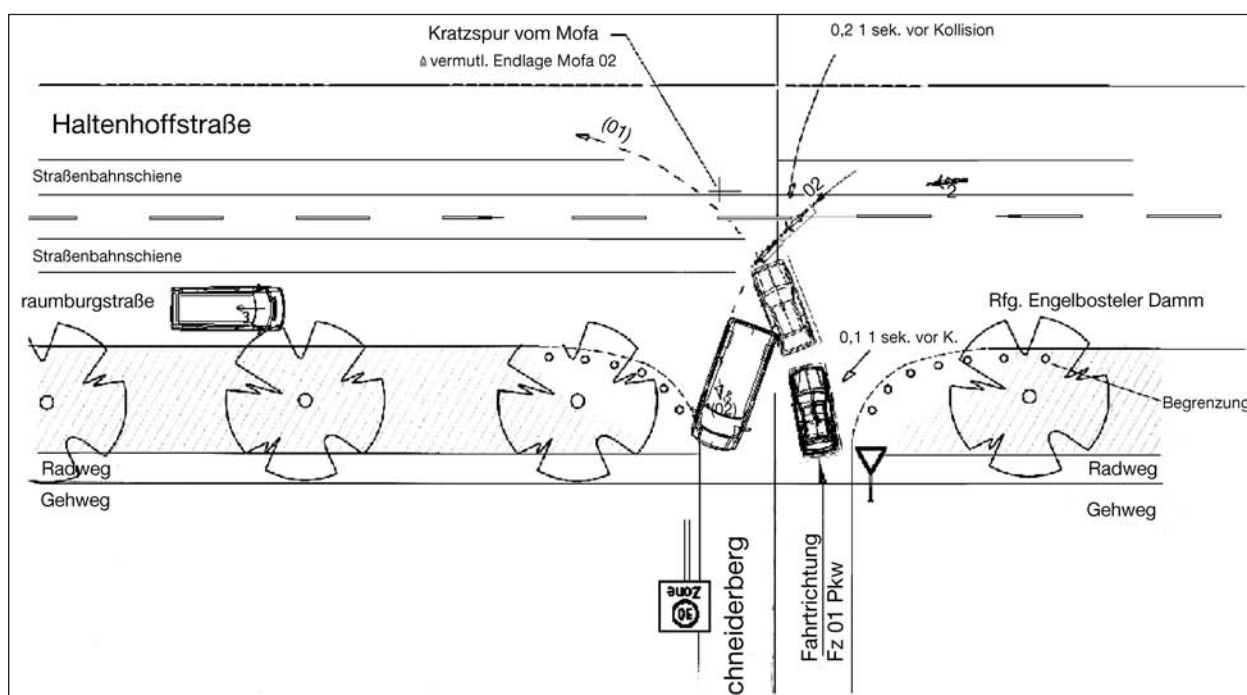

Fig. 6: Accident situation of example case (positions of car and two-wheeler at collision and pre-crash phase)

had waited in front of the intersection, she proceeded slowly across the plateau, the right-of-way street was difficult to overlook, as cars were parked at the sides of the street. Directly to the left of her a VW van was standing in a no-parking zone. The motorcyclist had approached from the right, but the car parking on the left had distracted her orientation.

Question concerning weather conditions:

It had been a sunny morning, she had been on her way to school with her daughter and her daughter's friend who had spent the night with them. It had been a very nice morning, but the sun had blinded her when orientating towards the right.

Question concerning development of the accident: She had not seen the motorcycle at all, "until he was under the car". She had entered the intersection quite slowly, she was glad that she had driven so slowly, otherwise the damage might have been worse.

Question concerning the duration of the waiting period at the intersection:

„Just like always.“ She had been able to enter the intersection quickly, she was able to remember traffic from the left, but not from the right, "up on the hump, left, right, left, just as always, then I drive on". This had been the case for years, she had always looked left, right, left and then had started. The traffic had not developed any different on this day from other days.

Question concerning the start and destination of the drive:

Just like every morning she had started at 08:45 a.m. at home in order to drive her child to school. The drive took always about 10 minutes, her daughter needed another 5 minutes to get into school. The school starts at 9 a.m. After the accident the children had continued on foot towards the school, that took about 7–8 minutes. She had to note that her child had had another accident in school: she had later fallen down the stairs.

Again a question concerning the development of the accident:

From the left a car had come, then she had not paid so much attention to the right side, the danger being always on the left. The motorcyclist had appeared just like "he had fallen from the skies".

Question concerning her personal well-being on the morning of the accident:

„Good mood, well rested...“ She had felt well, had not had any special worries or stresses and strains, everything had been "normal".

Question concerning the preventability of the accident:

She should have looked again to the right. She believed that she had trusted the sequence of the situation too much, that she had relied too much on the situation: "One knows the route, everyday, just like always." She had the feeling that she had started pretty well across the intersection as nothing special had happened.

Probing about her current behavior at the site of the accident:

She looked more today or waited longer or took a different route. There was another way that she chose for taking her daughter to school, but this was "more curved", did not take longer, though.

What could be improved at the site of the accident:

The cars parking at the corners of the intersection always constitute a problem. This leads to an impaired visibility.

Results of the questioning at the site of the accident (motorcycle driver):

Question concerning the development of the accident: He had wanted to turn left, in front of him there had been a truck and which had also turned left. He had had the impression that the driver of the car had been looking at him, which was why he had continued. The driver of the car had looked to the left, because from the left from her point of view a VW van had approached, "at that moment she takes off and hits me squarely".

Question concerning the destination:

He had wanted to see the doctor, the practice was directly opposite and he still had had time, as the practice only opens at 09:00 a.m.. He had driven very slowly.

Question concerning the avoidability of the accident:

He assumed that the driver, as she was looking to her right in his direction, had been blinded by the sun. He believed that the driver had concentrated to the left on the passing VW van. Also, her car had entered the intersection a little too far, while she was still waiting.

Question concerning the perception conditions at the site of the accident:

In order to turn into the main arterial, the car drivers had to approach very closely. In his opinion the intersection should be changed in order to allow the drivers of approaching vehicles a better visibility of the thoroughfare.

From the Collected Features to Coding

Based on the above deliberations the original questionnaire for persons involved in an accident a directive was derived, that is suitable for the execution of the collection at the site of the accident immediately after the accident (attachment 3: "interview on-site"). The directive has the purpose to extract the most important information from the persons involved in the accident in a short period of time, the use of a recording device is recommended. The directive is subdivided into the following groups of questions:

1. introduction
2. direction of movement/perception of danger/type of reaction/time
3. evaluation of the accident and its causes/action error
4. well-being and health on the day of the accident/progress and purpose of the drive
5. experience and habits of the driver/attitude towards driving
6. termination of the interview

Under ideal conditions the directive can be edited at least in its obligatory parts by a direct questioning after the accident. In the most cases it will become necessary to ask the persons involved in the accident a few days after the event again (supplementary).

It is a further task of the investigation team, to analyze the site of the accident towards its perception conditions. For this purpose, another directive has been set up for the investigation team: psychological indicators for the judging of the site of an accident (cf. in attachment 5 the main categories).

The coding of the individual features for a subsequent integration in a data matrix of the accident research is executed using coding sheets, where the corresponding code number is attributed to every collected feature specification.

In the above example, the erroneous behavior of the car driver was attributed to a perception error through distraction, i.e. "internal distraction caused by time/deadline pressure" (cf. attachment 2, coding Nr. 6). From the information supplied by the investigated person it can be gathered that she had only a limited time frame available for getting the children to school: 10 minutes drive and 5 minutes walk for the children. As the accident happened at 8:55 a.m. and school started at 9:00 a.m., the influence of an internal distraction because of time pressure can be assumed. Based on the results of the questioning, the driver of the car had mistakenly assumed to have completed the problem of the turning and orienting. Consequently, she had assessed the situation wrongly and omitted a major error concerning the coping with the traffic situation and the prevention of the accident vital action (renewed orientation). These results were supported by the interrogation of the motorcycle driver, as well as the influence of being blinded by the sun. This is an error of performance or judgment by an interpretational error, which we code as "confirmation or confidence error" (cf. attachment 3, code number 1). As the observation behavior of the driver of the car according to her statement at the site of the accident is extremely routinized, the current case is additionally characterized by an "error of expectation/routine error", code number 3. These codings characterize the events shortly before the critical approach behavior of the two vehicles; the interpretation and the actions in the face of immediate danger are coded similarly. As the driver of the car did not observe or recognize an immediate danger during turning, the phase of the "instable state" is coded accordingly (cf. attachment 6, code number 0: not interpreted as dangerous).

In a similar manner, perceptions and action errors of the other persons involved in an accident can be coded; additionally codings are executed for the assessments of the site of the accident (cf. attachment 7: codings no. 7 and 9 for an increase in complexity due to cross-traffic and parking vehicles).

The gathering of the causes resulting from human erroneous assessments and action errors results together with the formal accident cause (disregarding the right of way) as provided in our example in a better transparency towards the origins of the accident.

Summary and Outlook

The objective of the above study within the investigations at the site of the accident is the interdisciplinary acquisition of "human factors" at the origin of accidents and the setting up of a method to integrate these into a database. The main objective is to determine causative factors in their interaction and their co-dependence. The basic psychological model of the accident sequence comprises psychological indicators for the judging of the site of an accident (analysis of the perception conditions) as well as a classification of the data gleaned from the interrogations on-site in the accident-sequence-model. Perceptions, evaluations, decisions, action intentions and executions as well as perception and action limiting conditions are determined using a questionnaire on persons involved in an accident and can be integrated in the data structure of the accident research concerning their feature specifications and combined with other features.

The methodology of the traffic psychological accident analysis in the course of in-depth investigations at the Medical University of Hannover introduced herein has set up the following minimum requirements for the description and explanation of an accident:

At first the site of an accident has to be categorized according to its condition and the predominant perception conditions, where next to the already mentioned psychological indicators (attachment 5) also a classification concerning the given traffic situation is executed (FASTENMEIER, 1995). Furthermore the driving task should be described that the persons involved in the accident had to deal with in spatial and chronological approximation to the site of the accident. A number of differentiated suggestions have been offered in different papers, but for the purpose of the accident analysis at the site of an accident simple yet precise classifications are preferable, such as the "prototypical driving tasks" according to JENSCH, SPOERER and UTZELMANN (1977). Concerning the traffic situation and the driving task that has to be managed, the concrete actions of the driving manoeuvres as well as the emergence reaction, also in codable form, should be described. On this level the perception and action errors are to be identified, that have to be set in relation to the objective conditions of the site of the accident (e.g. to the conditions that limit

perception). A further emphasis of the analysis of the pre-crash phase is put on the classification of interpretations, expectations and intentions of the persons involved in the accident.

The next steps for the further development of this methodology consist in the creation of a sensible control system, on which the psychological data combinations for the analysis of the causes is based, furthermore the continued testing and optimization of the instruments in the course of further investigations and analyses. This procedure of a retrospective analysis of accident causes should, provided a sufficient number of individual cases, permit the possibility of an optimized accident research in the foreseeable future.

References

- APEL, A. (1996): Fahrermodell für kritische und normale Fahrsituation. In: Vortragsausdrucke der IX. Iff-Tagung (S. 175-210), Institut für Fahrzeugtechnik, TU Braunschweig
- CIER, D., FERRANDEZ, F., FLEURY, D., MALATERRE, G. & SAAD, F. (1983): Contract d'étude Assecar/ONSER 1982: Étude détaillée d'accidents orientée vers la sécurité primaire. Rapport intermédiaire. ONSER, Salon de Provence, Avril 1983
- FASTENMEIER, W. (1995): Autofahrer und Verkehrssituation. In: HÄCKER, H. (Hrsg.), Reihe Mensch-Fahrzeug-Umwelt, Band 33. Bonn: Deutscher Psychologen-Verlag
- JANSSEN, W. G. (1979): Routepbanning en gebeding, Een literatuur-studie, Report IZF C-13. Sosterberg: Institute for Perception, TNO
- KÜTING, H. J. (1990): Zur Analyse von Denk- und Handlungsfehlern beim Autofahren. In: W.-R. NICKEL (Hrsg.) Fahrverhalten und Verkehrsumwelt. Köln: Verlag TÜV Rheinland, 167-181
- HALE, A. R. & GLENDON, A. I. (1987): Individual Behavior in the Control of Danger. Amsterdam: Elsevier
- HEINRICH, C. H., PORSCHE, K. M. (1989): Die Bedeutung interaktiver Unfallmodelle für die Straßenverkehrssicherheitsforschung. Zeitschrift für Verkehrssicherheit 35, 8-17

JENSCH, M., SPOERER, E., UTZELMANN, H. D. (1978): Verkehrsverhaltenslehre. Köln: Bundesanstalt für Straßenwesen

KESKINEN, E. (1996): Warum ist die Unfallrate von jungen Fahrerinnen und Fahrern höher? In: Junge Fahrer und Fahrerinnen. Berichte der Bundesanstalt für Straßenwesen, Heft M 52

McDONALD, G. L. (1972): The Involvement of Tractor Design in Accidents. In: Research Report 3/72, Department of Mechanical Engineering: University of Queensland, St. Lucia (zit. nach HALE & GLENDON, 1987)

MAREK, J., STEN, T. (1977): Traffic Environment and the Driver. Springfield: Thomas

RASMUSSEN, J. (1986): Information Processing and Human-Machine Interaction. An Approach to Cognitive Engineering. New York: North-Holland

RASMUSSEN, J. (1995): The Concept of Human Error and the Design of Reliable Human-Machine Systems. In: H. P. WILLUMEIT & H. KOLREP (Hrsg.), Verlässlichkeit von Mensch-Maschine-Systemen, 255-271, Berlin: Technische Universität Berlin

RASMUSSEN, J. & LIND, H. (1982): A Model of Human Decision Making in Complex Systems and its Use for Design of System Control Strategies. In: Proc. American Control Conference, 270-276

REASON, J. (1994): Menschliches Versagen: psychologische Risikofaktoren und moderne Technologien. Aus dem Amerikan (1990). Übers. von Joachim GRABOWSKI. Heidelberg: Spektrum Akademischer Verlag

PUND, B. & NICKEL, W.-R. (1994): Psychologische Untersuchungen am Unfallort. Berichte der Bundesanstalt für Straßenwesen, Heft M 27

SURRY, J. (1969): Industrial Accident Research: A Human Engineering Appraisal. University of Toronto, Department of Industrial Engineering

OTTE, D.: The Accident Research Unit Hannover as Example for Importance and Benefit of Existing In-Depth Investigations, SAE 940712, 1994

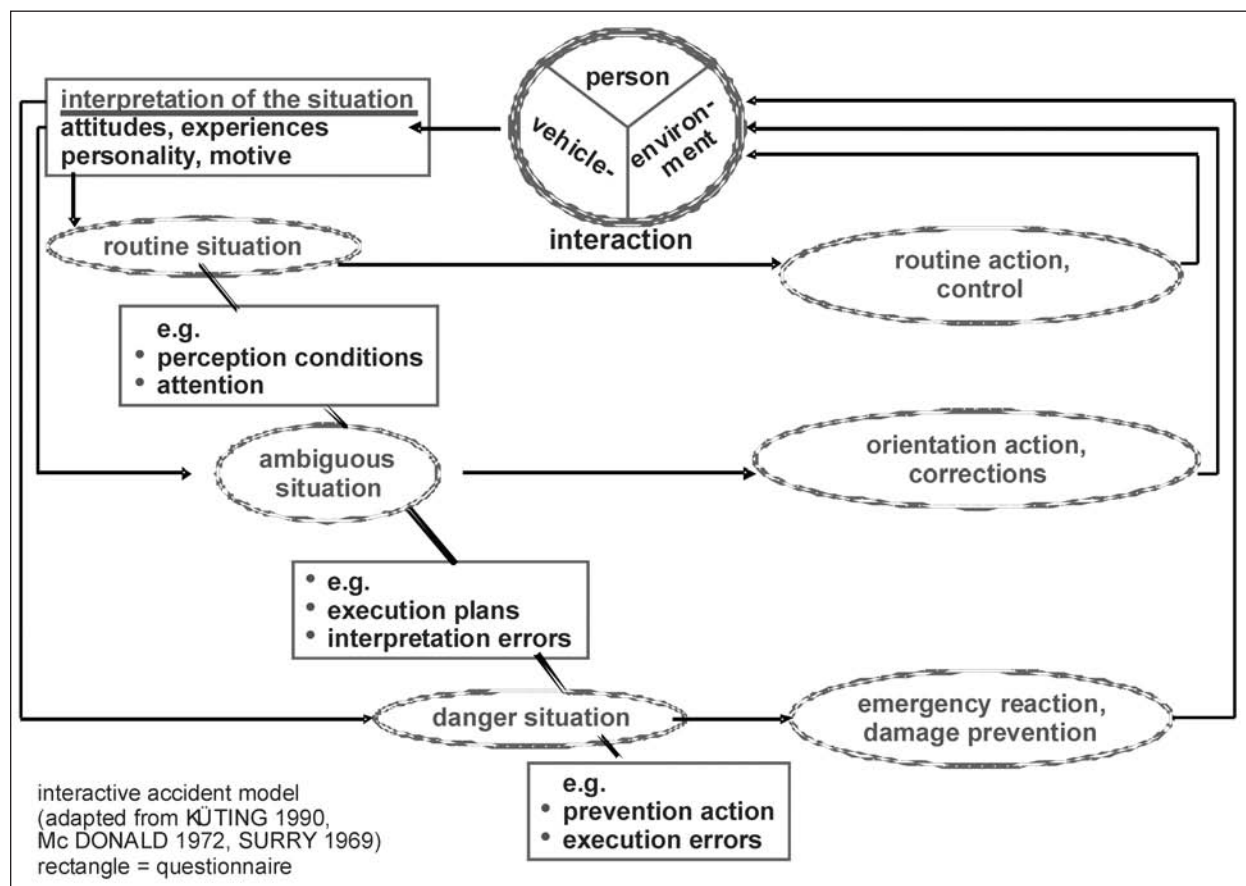

Attachment 1

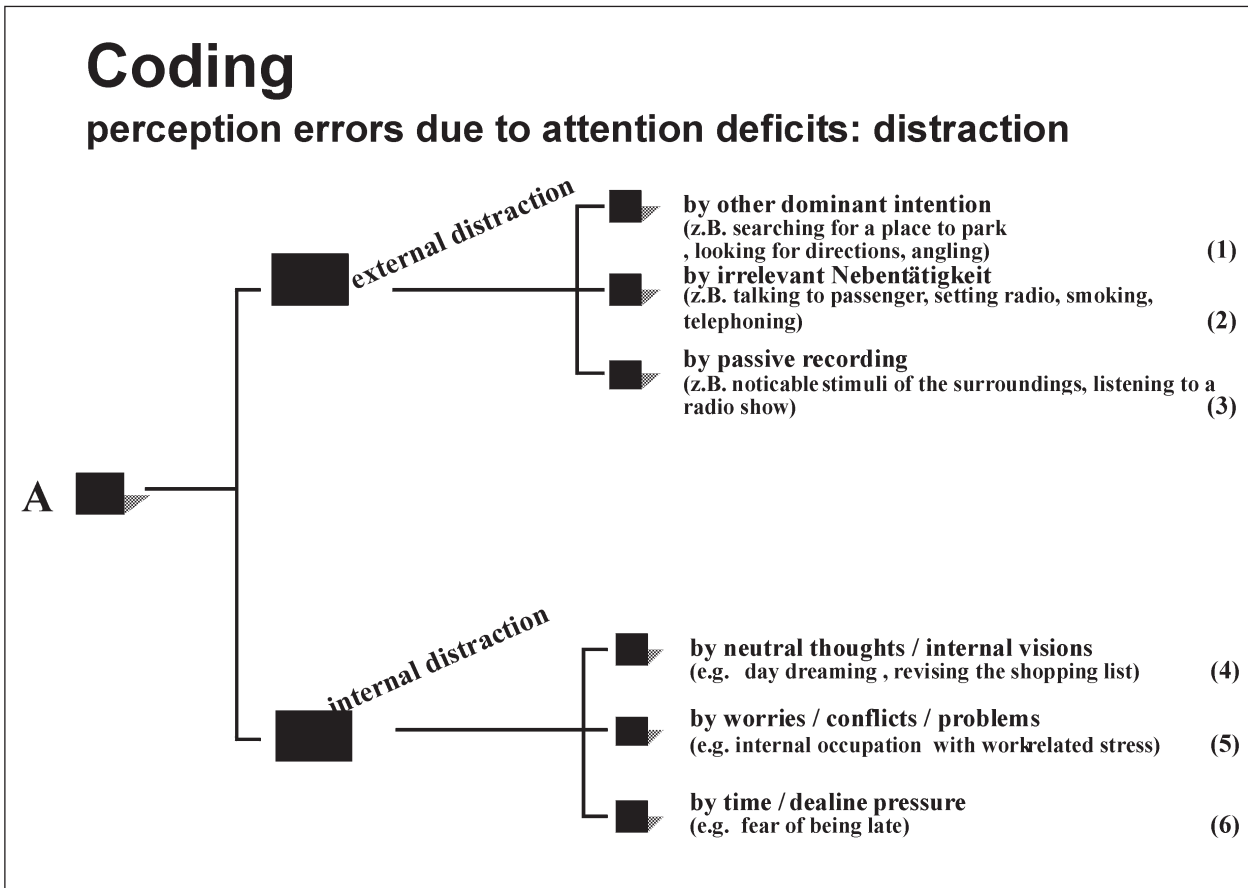

Attachment 2

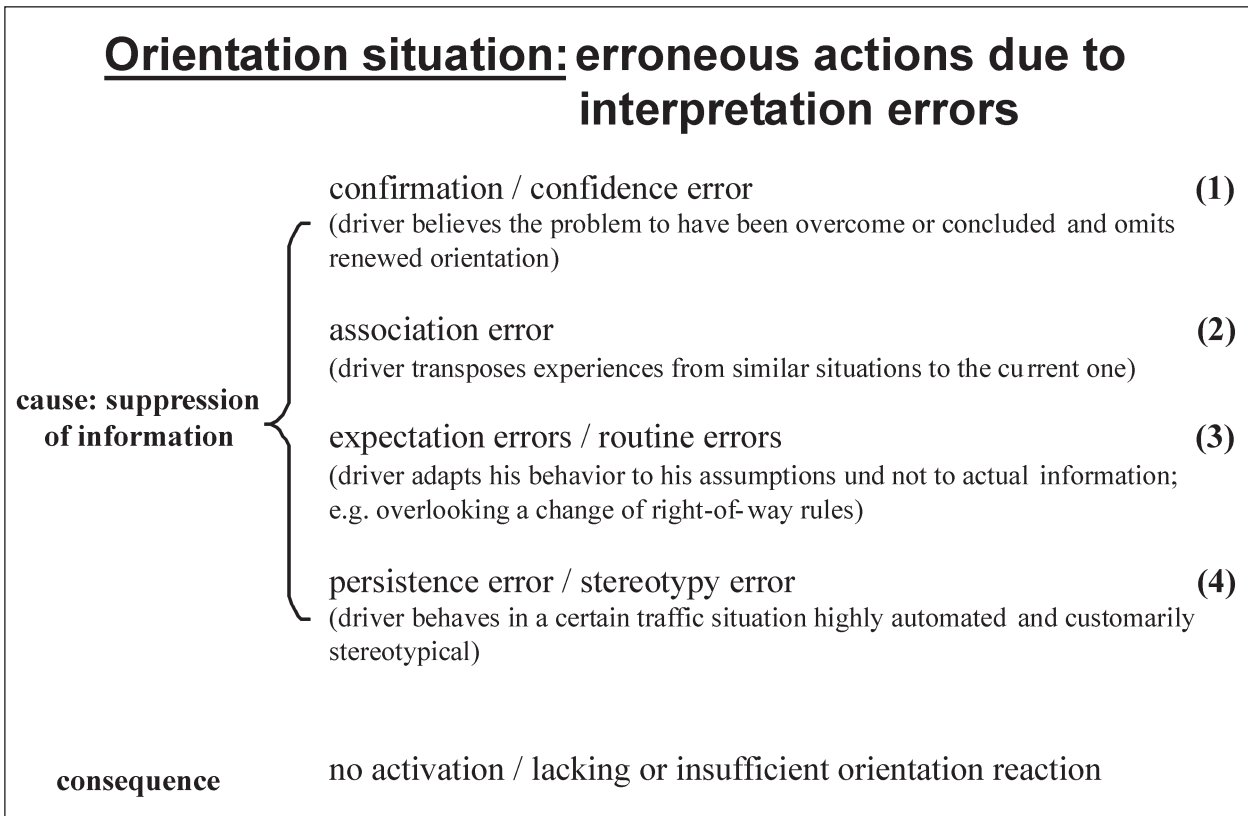

Attachment 3

Questionnaire for the "interview on-site"

(arrow → mandatory question)

(circle O question is expendable, as it is also covered by the report of the team)

1. Opening the interview

→ Introduction/showing understanding / transition to the purpose/reference to protection of privacy and recording device)

- What is your first thought when thinking about the accident?

→ Now tell us from your point of view how the accident happened.

2. Direction of movement/Danger perception/Reaction/Time

O Which was your initial direction? Where were you going?

→ Where was the other person coming from? When and where did you notice him first?

- When did you first notice danger?

- What caught your attention?

→ What were you thinking of when you noticed the danger?

- What did you decide to do? Why? Did it work?

- What was your first action when you noticed the danger? (did you brake, accelerate, swerve? Controlled or suddenly?)

Signal, wave?

- How did the other react? How did your vehicle?

→ Were you distracted shortly before the accident?

→ Were there problems concerning visibility? (Which?)

→ How long did it take from the moment you noticed the danger until the point of impact?

- Was there something you noticed too late? (or the last moment?)

→ How fast were you going, when you noticed the danger? And your opponent?

→ How fast were you at the point of impact? The opponent?

3. Evaluation of the accident and its causes/action errors

→ Did you expect a danger?

→ What would you call warning signals when looking back?

→ Did you have the feeling that you still had the situation under control shortly before the accident?

- What could you have done, in order to prevent the accident?

- Who or what caused the accident according to your opinion?

O How often do you drive this route?

→ What is the standard traffic situation when you normally drive along here?

→ Did you expect that it would be different this time? Was it any different?

→ What would you improve at this site / along this route?

- How did you feel 1 second before the impact? (heart rate/trembling/sweat/shortness of breath/constricted throat?)

- How do you assess your reaction speed at during the accident? And in general?

- What was your first thought right after the accident?

- What was the first thing you did right after the collision?

4. Personal condition on the day of the accident/ course of the drive and its purpose

→ How well did you sleep the night before the accident? How did you feel in the morning?

→ What did you do during the last 24 hours before the accident? And right before starting for the drive?

→ Were there any events before the accident? Did you have any special sorrows, worries, stress, strains?

→ What were you thinking of during the drive?

- Did any extraordinary things happen right before the accidents? (were you distracted?)

- How much traffic was there? How many in front of you/behind you?

→ Where were you coming from? Where were you going?

→ How did the drive progress right up to the accident? Just like always?

→ At what time did you start? How many kilometers had you driven when the accident occurred? How many kilometers are there still to go until your destination?

→ At what time had you planned to arrive?

→ Were you in a hurry? Were you held up in traffic, by traffic back-ups etc.?

- How many cigarettes do you smoke daily? Did you smoke during this drive? When the accident occurred?

- Did you listen to the radio or tapes? Which station? Did you shortly before the accident change stations or tapes?

→ Were you ill lately? Treated medically?

O Which medications do you take? Regularly? Did you take any medication within 24 hours of the accident?

→ When did you last drink alcohol? How much? Drugs?

5. Driving experience and habits/ Attitude towards driving

O Driving license (Date of issue? Category?) Any limitations/ restraints entered?

O Wearing glasses or contact lenses during the drive that led to the accident?

→ Annual number of kilometers driven? Number of kilometers driven in professional capacity?

→ In how many accidents were you involved as a driver up to now? How many points have you got?

- How do you prepare for drives in general? How much spare time do you assess in general? And today?

- How often do you drive per week? How many kilometers per day? How often do you take the same roads and do you also travel new routes?

- Do you drive mainly in the city or cross-country? Where do you like driving best?

→ Why did you buy exactly this car? What do you like best?

O Which type of car? How much power?

O Which optional components or extra equipment does your car have? (ABS, automatic transmission/air conditioning turned on?)

Do you also drive other types of vehicles? Which?

→ What percentage of drivers are worse drivers than you are?

- Which consequences will this accident have on your future driving behavior?

- Will it have any personal or professional consequences for you?

6. Termination of the interview

- Is there something else you noticed during the accident?

→ How do you feel now?

→ Thank you very much for your cooperation, you have helped us a lot.

→ In a few weeks you will receive a questionnaire, please complete it and return it to us.

Your contribution to the prevention of future accidents.

Psychological indicators for the evaluation of the site of the accident

(analysis of the perception conditions)

- reference system
- predictability
- difficulty of the driving action
- information relaying
- visibility, clarity
- complexity

Attachment 5

Coding

interpretation of the immediate danger
(instable state)

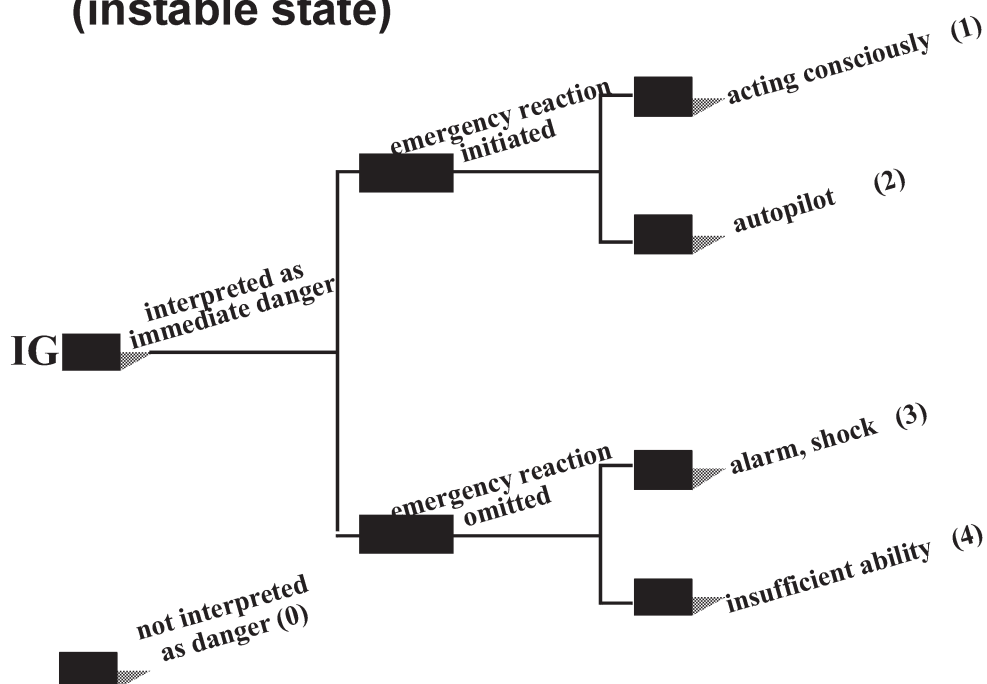

Attachment 6

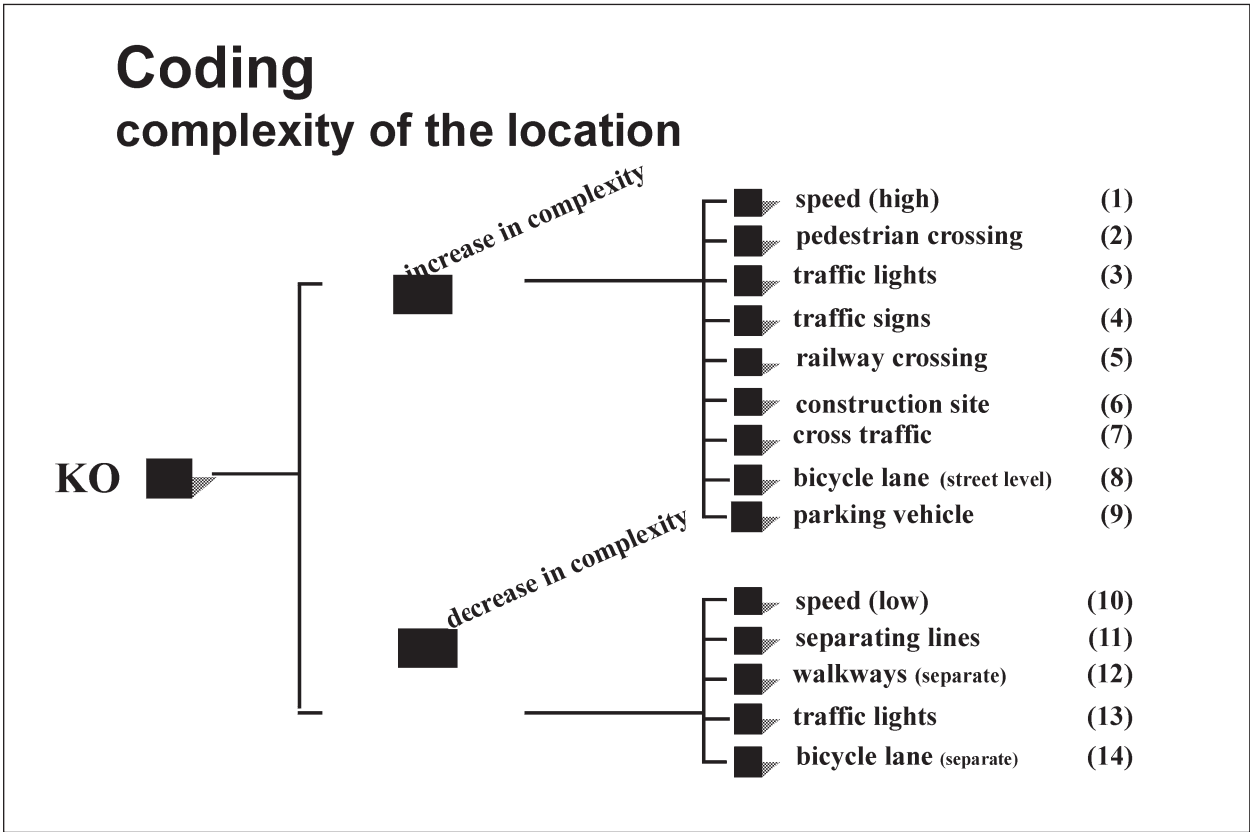

Attachment 7

J. Lenard, J. Hill
VSRC, Loughborough University,
Loughborough, United Kingdom

Interaction of Road Environment, Vehicle and Human Factors in the Causation of Pedestrian Accidents

Abstract

The UK On-the-Spot project (OTS) completed over 1500 in-depth investigations of road accidents during 2000-2003 and is continuing for a further 3 years. Cases were sampled from two regions of England using rotating shifts to cover all days of the week and all hours of the day and night. Research teams were dispatched to accidents notified to police during the shifts; arrival time to the scene of the accident was generally less than 20 minutes. The methodology of OTS includes sophisticated systems for describing accident causation and the interaction of road, vehicle and human factors. The purpose of this paper is to describe and illustrate these systems by reference to pedestrian accidents. This type of analysis is intended to provide an insight into how and why pedestrian accidents occur in order to assist the development of effective road, vehicle and behavioural countermeasures.

Introduction

The On-the-Spot accident research project (OTS) conducts in-depth investigations of road traffic accidents to build a database rich with findings about the causes of accidents and injuries. The project is funded by the UK Department for Transport and the Highways Agency and aims to provide a resource that will assist safety professionals in their efforts to make the roads safer for everyone. Investigators are deployed to the scene of 500 road crashes each year where they gather data that would otherwise be quickly lost. Arrival time to the scene of the accident is generally less than 20 minutes. Independent teams from Loughborough University and TRL Ltd sample accidents from the Nottinghamshire and Thames Valley regions respectively. The teams operate rotating shifts to cover all days of the week and all hours of the day and night. All road traffic

accidents notified to police during the periods of operation are eligible for the sample. The first phase of data collection lasted 39 months and was completed in September 2003. A second phase scheduled for a further 3 years followed without interruption. Further descriptions of the project are available [1-4].

The data collected for OTS is highly detailed, wide ranging and sophisticated in structure. The forms and protocols that are used include new innovations and adaptations from earlier in-depth studies. This applies particularly to systems for describing accident causation and the interaction of road, vehicle and human factors. The purpose of this paper is to describe and illustrate these systems by reference to pedestrian accidents, at the same time providing an initial overview of pedestrian accidents investigated in OTS during the first phase of its operation.

Methodology

Upon completion of the first phase of OTS, case files from the two data collection groups were combined into a single database containing over 1500 accidents. The results presented in this paper are based on the 115 pedestrian accidents in the database. Records are held on 117 pedestrians and 130 vehicles from this group of accidents.

The results section begins with a short overview of pedestrian accidents using a small number of variables. This is followed by selected results to illustrate the systems for coding accident causation in OTS. It should be recognised that the scope and depth of the OTS database far exceeds the sample of results presented in this paper. The focus here is on the methodology for describing just one aspect of the investigations, accident causation.

Systems for Coding Causation in OTS

Based on their history and development, the full details of which cannot be given here, it is possible to distinguish 5 systems in OTS for describing accident causation: (1) the 1995 UK police system, (2) causative features, (3) crash causation code, (4) interaction codes and (5) self-reported assessments (questionnaire). In addition 'defects and failures' are directly identified by the accident teams where possible.

The 1995 UK police system was developed by the former Department of Transport with TRL and has been adopted by 18 police forces in the UK since 1997. It is a harmonised two-tier system which seeks to identify (a) the critical failure or manoeuvre which led to the accident and (b) the factor or factors which contributed to this failure or manoeuvre. These are referred to in OTS as the precipitating and causal factors respectively (see table 9, table 10 and table 11). This system was reviewed as part of the SCRAS Quinquennial Review and a revised form will be introduced nationally for all police forces in 2005. [5]

'Causative features' is a method of coding used in OTS to supplement the observed presence of a feature by an assessment of whether it was definitely, probably, possibly or not causative. It is widely used in association with parameters that describe the highway, physical surroundings or environmental conditions. In this report the separate categories of definitely, probably and possibly causative are aggregated into a single 'causality indicated' group (cf. table 12).

The 'crash causation code' provides a list of about 20 options for saying why a crash occurred. Almost all of these relate to the driver. It is understood that this list originates from earlier accident studies and was incorporated into OTS to provide direct comparability with earlier research findings (cf. table 13).

'Interactions' relate a road user to the road environment (highway), vehicle or road user, including him- or herself. There are 7 categories of interactions of which 3 are illustrated in this paper: perception, attention and impairment. 'Looked but did not see' is an example of an interaction in the perception category. The full list covers a very wide range of factors. This system was an innovation for OTS developed by TRL at the beginning of the study (cf. table 14 and table 15).

A questionnaire is sent out to road users involved in the OTS sample of accidents. Included are questions that ask the road user about factors that he or she regards as contributing to the accident. These self-reported causal factors are treated separately from the other systems because they do not represent the considered judgement of an OTS investigator-they purely report the opinions of the road user (see table 16).

Results

Overview of Pedestrian Accidents

Table 1 shows the number of pedestrian accidents in the OTS database by sample region and accident severity (as assessed at the time of the accident). Most accidents involved some degree of injury even though there was no pre-selection or filtering of cases within the sample regions.

Any accident in which a pedestrian was struck is included in the sample; hence a minority of accidents (14) involved two or more vehicles, as shown in table 2.

Table 3 shows the time of day in which the accidents occurred. The most frequent (44) time band spanned late afternoon to early evening, 1600-1959.

Precipitation at the time of the accident is given in table 4. No form of rain or snow is recorded in most cases (90).

	Non-injury	Slight	Serious	Fatal	Total
Nottinghamshire	2	49	18	5	74
Thames Valley	1	19	15	6	41
Total	3	68	33	11	115

Tab. 1: Pedestrian accidents by sample region and injury severity

Single vehicle	car	87
	light goods vehicle	2
	heavy goods vehicle	2
	bus	5
	motorcycle	1
Multiple vehicle		14
Other/unknown		4
Total		115

Tab. 2: Road user involvement

0000-0359	4
0400-0759	4
0800-1159	23
1200-1559	32
1600-1959	44
2000-2359	7
Unknown	1
Total	115

Tab. 3: Time of day

None	90
Light shower	6
Heavy shower	2
Drizzle	6
Moderate rain	5
Heavy rain	3
Light snow	1
Other/unknown	2
Total	115

Tab. 4: Precipitation

Most accidents (95) occurred in urban areas, as shown in table 5.

Table 6 shows the types of roads in which the accidents occurred ranging from motorways to unclassified roads. Where the accident occurred at a junction, the 'higher' class of road is coded (e.g. A-road in preference to C-road).

Table 7 shows that over half of the accidents (63) occurred in 30mph speed limit zones. Where the accident occurred at a junction, the higher applicable speed limit is coded.

Table 8 shows the age of pedestrians. Where known, about half (46) were under 18 years of age.

Urban	95
Rural	16
Other	4
Total	115

Tab. 5: Area

Motorway	1
A-road	49
B-road	17
C-road	13
Unclassified	30
Other	5
Total	115

Tab. 6: Road classification

15	1
30	63
40	7
50	1
60	6
70	2
Other/unknown	35
Total	115

Tab. 7: Speed limit (mph)

0-17	46
18-24	7
25-59	25
60-100	13
Unknown	26
Total	117

Tab. 8: Pedestrian age (years)

Description of Accident Causation

Precipitating factors in the 1995 UK police system are considered to have initiated the accident. In most cases only one entry should be mentioned for each accident. The most frequent entry (81) is pedestrians entering the carriageway without due care, as shown in table 9.

Table 10 and table 11 form a single table showing an extract of causal factors from the 1995 UK police system. These factors are considered to have contributed to the initiation of the accident.

Failure of driver or rider	Failed to stop	7
	Failed to give way	5
	Failed to avoid pedestrian	18
	Failed to avoid vehicle or object	4
	Failure to signal or misleading signal	1
	Loss of control of vehicle	4
Failure of pedestrian	Entered carriageway without due care	81
	Fell in road	4
Manoeuvres	Swerved to avoid object	-
	Sudden braking	3
	Poor turn or manoeuvre	4
	Poor overtake	-
	Drove wrong way	-
	Opened door carelessly	-
	Other	-

Tab. 9: 1995 UK police system-precipitating factors (115 accidents)

Personal factors	Impairment through alcohol	9
	Impairment through drugs	2
	Impairment through fatigue	-
	Impairment through illness	2
Distraction	Stress or emotional state of mind	3
	Object on or in vehicle	1
	Object outside of vehicle	2
Behaviour	Panic behaviour	-
	Careless, reckless, thoughtless	14
	Nervous or uncertain	-
	In a hurry	22
Other factors	Failure to judge other's path or speed	21
	Disability	1
	Failed to look	34
	Looked but did not see	22
	Inattention	28
	Dark or inconspicuous clothing	11
	Other	4
Pedestrian details	Cross from behind parked car	16
	Ignored lights at crossing	11

Tab. 10: 1995 UK police system-causal factors (115 accidents)

More than one can be nominated for each accident. The most frequent item mentioned is 'Failed to look' (34).

Table 12 illustrates a group of variables whose presence or absence is noted on the OTS database along with the assessment that they were definitely, probably, possibly or not causative. Here the first 3 categories are aggregated in the 'causality indicated' column. The road being icy was considered to be at least possibly causative in one case. A comprehensive examination of accident causation in OTS would need to take account of hundreds of such variables on the database.

The crash causation code allows investigators to nominate events, mostly concerning the driver, that caused the accident. A selection of items is shown in table 13. For this group of 130 vehicles involved in pedestrian accidents the most frequent choice was 'vehicle not to blame' (83). In a significant number of cases (13) the driver was considered to have looked but not seen the pedestrian.

Table 14 and table 15 form a single table describing relationships or 'interactions' between road users and objects in the vicinity (including themselves). In this presentation of results the number of road users is shown for whom at least

Vehicle condition	Tyre pressures wrong	-	
	Tyre deflated before impact	-	
	Tyre worn/insufficient tread	1	
	Defective lights or signals	-	
	Defective brakes	1	
	Other	-	
Local conditions	Poor surface at site	1	
	Poor/no street lighting	2	
	Inadequate signing at site	1	
	Steep hill at site	3	
	Narrow road at site	-	
	Bend/winding road at site	1	
	Road works at site	-	
	Slippery road at site	3	
	High winds at site	-	
	Earlier accident	-	
	Other	-	
	Obscuration	View obscured from window	1
		Glare from sun	3
Glare from headlights		-	
By bend/winding road		-	
By stationary/parked vehicle		14	
By moving vehicle		-	
By buildings, fences, vegetation etc.		1	
Obscuration due to weather		3	
Failure to see pedestrian in blind spot	1		
Animal	Out of control	1	

Tab. 11: 1995 UK police system-causal factors (continued)

		Causality indicated
Weather-related	road damp (patches)	-
	road damp	8
	road wet (isolated)	2
	road wet (widespread)	13
	road icy	1
	road snow	-
	road frost	-
	road salty	-

Tab. 12: Sample 'causative features' data: weather-related (229 approaches)

Vehicle not to blame	83
Looked but did not see pedestrian	13
Driver made illegal road manoeuvre	2
Driver made reckless road manoeuvre	4
Dazzled by sun	1
Vision obscured	3
Error of judgement	3
Lost control of vehicle	2
Deliberate action	1
Vehicle fault	2
Other/unknown	16

Tab. 13: Sample crash causation codes (130 vehicles)

	Interaction	Driver	Pedestrian
Perception	Did not look for	12	35
	Looked but did not notice item in plain view	5	1
	Looked but did not discern	3	1
	Looked but did not see-obstruction on carriageway	5	5
	Looked but did not see-obstruction off carriageway	1	1
	Looked but did not see due to carriageway geometry	2	
	Looked but did not see	2	7
	Saw but did not perceive a hazard	15	1
	Anticipated incorrectly likely position		
	Anticipated incorrectly likely path	3	1
	Anticipated incorrectly likely speed		2
	Anticipated incorrectly likely acceleration	1	
	Anticipated incorrectly likely deceleration		
	Anticipated incorrectly likely motion		1
	Misperceived the road layout		5
	Misperceived a likely event	9	11

Tab. 14: Sample interaction codes (126 drivers; 117 pedestrians)

	Interaction	Driver	Pedestrian
Attention	Distraction by a passenger in own vehicle	2	
	Distraction by an internal event		1
	Distraction due to another road user		3
	Distraction due to previous accident/incident		
	Distraction due to an external event		
	Inattentive due to panic/nervousness		1
	Inattentive due to stress		
	Inattentive due to being in a hurry		20
	Inattentive due to personal reason		1
	Was inattentive	3	22
Impairment	Suffered non-fatal illness		
	Died of natural causes		
	Suffered illness		1
	Due to alcohol		6
	Due to recreational drugs		
	Due to medicinal drugs		1
	Due to consumed substance		
	Due to fatigue		
	Was locally temporarily visually impaired by glare	1	
	Was locally temporarily visually impaired by weather	1	
	Was locally temporarily visually impaired	1	1
	Was personally impaired		2

Tab. 15: Sample interaction codes (continued)

		Driver	Pedestrian
	Did weather contribute?	5	3
	Did road surface contribute?	6	4
	Did other road user behave in careless manner?	14	6
	Did other road user behave in confusing manner?	6	1
Contributory factors	Misleading road layout		1
	Badly positioned road signs		
	Traffic lights not working		
	Road works		
	Other road users	6	4
	Distracted by changing radio stations etc.		
	Distracted by looking for something in vehicle?		
	Looking at street name or road signs		
	Distracted by disturbance in vehicle		
	External distractions		
	Mobile phone		
	Fatigue		
	Unwell		1
Late or in a hurry		2	

Tab. 16: System 5. Sample questionnaire data (64 drivers; 62 pedestrians)

one instance of the applicable interaction code was registered. One pedestrian, for example, is registered as looking but not seeing an item in plain view: it is possible that this pedestrian failed several times to see objects in plain view.

The most frequent cell in table 14 (35) is pedestrians who 'Did not look for...'. The database contains the information on what object they failed to look for – in most cases it can be presumed to be the vehicle that struck them. In this paper only the type of interaction is discussed, not the object with which the road user interacted.

There are 7 groups of interaction codes, of which 3 are included in table 14 and table 15. The data in these tables is therefore not a full and balanced presentation of OTS 'interaction' results.

Table 16 present a sample set of results from the road user questionnaire sent out to persons involved in OTS accidents. The most frequent cell (14) in this table is drivers who said that the other road user, the pedestrian, behaved in a careless manner.

Discussion

Table 9 shows the precipitating factors of the 1995 UK police system. This list of factors is intended to identify the critical failure or manoeuvre which led to the accident. The result which stands out most clearly is 81 cases where the pedestrian entered the carriageway without due care. In contrast the driver is said to have failed to avoid the pedestrian in 18 cases. The following two tables seek to identify causal factors – the factors which contributed to the critical failure (or manoeuvre). Most frequent are 'failed to look' (34), 'inattention' (28), 'looked but did not see' (22), 'in a hurry' (22) and 'failed to judge other's path or speed' (21). Not explicit in this system is whether these descriptions apply to the driver or the pedestrian – this information can be ascertained from other fields in the OTS database.

Table 12 is a sample result from hundreds that could have been presented. It shows that the road (or path) being wet on the approach to the point of impact was considered to be definitely, probably or possibly causative in 13 cases. This result can be taken together with table 4 which records no precipitation at the time of the accident for 90 of

the 115 cases, indicating the importance of wet roads when they occur.

A result that stands out in table 13, the crash causation code, is 'Vehicle not to blame' (83). After this is 'Looked but did not see pedestrian' (13). This resembles the 1995 UK police system in suggesting that the behaviour of the pedestrian is a key factor in the causation of pedestrian accidents. The complete set of crash causation codes is not presented in this table and so caution must be exercised in drawing wider conclusions.

'Interactions', examples of which are shown in table 14 and table 15, provide a sophisticated system for describing relationships between a road user and (a) the road environment, (b) vehicles and (c) road users (including him- or herself). Interactions are shown here separately for drivers and pedestrians. The high number of entries in the 'Perception' category highlights the importance of perception in pedestrian accidents. The entry 'Did not look for...' occurs more often for pedestrians (12-35) whereas 'Saw... but did not perceive a hazard' occurs predominantly for drivers (15-1). This is confirmed and clarified in the 'Attention' group where 'Inattentive due to being in a hurry' and 'Was inattentive' occur far more for pedestrians than drivers (0-20 and 3-22 respectively).

A short extract from the results of the questionnaire survey for pedestrians and drivers involved in pedestrian accidents is given in table 16. A difference here is that drivers attribute careless and confusing behaviour more often to pedestrians than pedestrians do to drivers (14-6 and 6-1 respectively).

Conclusion

This short overview of systems in OTS for describing accident causation shows how the different systems highlight different aspects in varying levels of detail. The initial survey indicates that pedestrian behaviour, including attention and perception, is a key to understanding why pedestrian accidents occur. However the purpose of this paper is to illustrate OTS methodology by reference to sample pedestrian accident data, not to provide a balanced and detailed description of this class of accidents. Further analysis is required before it is appropriate to draw wider conclusions.

Acknowledgements

The OTS project is funded by the UK Department for Transport and the Highways Agency. The project would not be possible without help and ongoing support from many individuals, especially including the Chief Constables of Nottinghamshire and Thames Valley Police Forces and their officers. In addition the authors of this paper would like to thank the staff at Loughborough University and TRL Ltd who have helped to establish and carry out this project. The views expressed in this paper belong to the authors and are not necessarily those of the Department for Transport, Highways Agency, Nottinghamshire Police or Thames Valley Police.

References

- HILL, J. R., THOMAS, P. D., SMITH, M. AND BYARD, N.: "The methodology of on the spot accident investigations in the UK", ESV Conference, National Highway Traffic Safety Administration, 17th International Technical Conference on the Enhanced Safety of Vehicles held June 2001, Amsterdam, 2001, pp. 1-10
- FORMAN, P., HILL, J. R.: "The new 'On the Spot' crash investigation project in the UK", AIRIL 01 Conference, AIRIL 2001 Conference, University of British Columbia, Vancouver, Canada, August 2001, pp. 1-29
- HILL, J. R., BYARD, N., THOMAS, P. D.: "On the spot accident research in the UK", Traffic Safety on Three Continents, Traffic Safety on Three Continents held September 2001, Moscow, Russia, 2001, pp. 1-12
- CUERDEN, R., LUNT, H., FALLS, A., HILL, J. R.: "On The Spot Crash Investigations in the UK: New Insights for Vehicle Safety Research", Proceedings of the 18th International Technical Conference on the Enhanced Safety of Vehicles, US Department of Transportation, National Highway Traffic Safety Administration, ESV 2003, Nagoya, Japan, 19-22 May, 2003, 12 pp, [CD-ROM]
- HICKFORD, A. J., HALL, R. D.: "Review of the contributory factors system", Road Safety Research Report No. 43, Department for Transport, London, March 2004

Y. Page

Laboratoire d'Accidentologie, de Biomécanique et d'études du comportement humain, PSA Peugeot-Citroën/Renault (LAB), France

S. Cuny

Centre Européen d'Études de Sécurité et d'Analyse des Risques (CEESAR), France

Is ESP Effective on French Roads?

Abstract

Electronic Stability Program (ESP) aims to prevent the lateral instability of a vehicle. Linked to the braking and powertrain systems, it prevents the car from running wide on a corner or the rear from sliding out. It also helps the driver control his trajectory, without replacing him, in the case of loss of control where the driver is performing an emergency manoeuvre (confused and exaggerated steering wheel actions). A new ESP function optimizes ESP action in curves with hard under steering (situations in which the front wheels lose grip and the vehicle slides towards the outside of the curve). A complementary feature prevents the wheels from spinning when pulling away and accelerating. The name given to the ESP system varies according to the vehicle manufacturer, but other terms include: active stability control (ASC), automotive stability management system (ASMS), dynamic stability control (DSC), vehicle dynamic control (VDC), vehicle stability control (VSC) or electronic stability Control (ESC).

This paper proposes an evaluation of the effectiveness of ESP in terms of reduction of injury accidents in France. The method consists of 3 steps:

- The identification, in the French National injury accident census (Gendarmerie Nationale only), of accident-involved cars for which the determination of whether or not the car was fitted with ESP is possible. A sample of 1 356 cars involved in injury accidents occurred in 2000, 2001, 2002 and 2003 was then selected. But we had to restrict the analysis to only 588 Renault Lagunas.
- The identification of accident situations for which we can determine whether or not ESP is

pertinent (for example ESP is pertinent for loss of control accidents whilst it is not for cars pulling out of a junction).

- The calculation, via a logistic regression, of the relative risk of being involved in an ESP-pertinent accident for ESP equipped cars versus unequipped cars, divided by the relative risk of being involved in a non ESP-pertinent accident for ESP equipped cars versus unequipped cars. This relative risk is assumed to be the best estimator of ESP effectiveness.

The arguments for such a method, effectiveness indicator and implicit hypothesis are presented and discussed in the paper. Based on a few assumptions, ESP is proved to be highly effective. Currently, the relative risk of being involved in an ESP-pertinent accident for ESP-equipped cars is lower (-44%, although not statistically significant) than for other cars.

Introduction

"I do not seek answers. I seek to understand questions" (Confucius)

Electronic Stability Program (ESP) aims to prevent the lateral instability of a vehicle. Linked to the braking and powertrain systems, it prevents the car from running wide on a corner or the rear from sliding out. It also helps the driver control his trajectory, without replacing him, in the case of loss of control where the driver is performing an emergency manoeuvre (confused and exaggerated steering wheel actions). A new ESP function optimizes ESP action in curves with hard under steering (situations in which the front wheels lose grip and the vehicle slides towards the outside of the curve). A complementary feature prevents the wheels from spinning when pulling away and accelerating. The name given to the ESP system varies according to the vehicle manufacturer, but other terms include: active stability control (ASC), automotive stability management system (ASMS), dynamic stability control (DSC), vehicle dynamic control (VDC), vehicle stability control (VSC) or electronic stability Control (ESC).

ESP has been a topic of considerable interest since the late 1990s because it concerns a high number of accidents. In 2002, in Europe (15 countries), 1 227 000 injury accidents occurred, 1 670 000 road users were slightly or seriously injured and

37 660 lost their lives (source: CARE database, EU quick indicator, 2004). It is unknown how many of these crashes resulted from loss of control according to its dynamic definition¹, i.e. ESP-pertinent crashes. The CARE database does not record such information. Consequently, the magnitude of loss of control accidents is not accessible from intensive databases and must be estimated from published papers. LANGWIEDER et al. estimated the proportion of skidding accidents in Germany at 25% for injury accidents and 40% for fatal accidents (LANGWIEDER et al., 2004). UNSELT et al. estimated these same proportions at, respectively, 21% and 43% (UNSELT et al., 2004). In the same way, BECKER et al. estimated ESP-pertinent fatal crashes in Germany at 40%, using GIDAS² data (BECKER et al., 2004). BAR and PAGE estimated that, in France, these proportions would be around 20% and 40% (BAR et PAGE, 2002). The same is true for Japanese injury crashes (AGA and OKADA, 2003).

If we rely on these consistent estimates, each year in Europe (15 countries), approximately 240 000 injury crashes and 15 000 fatalities result directly or indirectly from loss of control, other factors being of course also relevant in the accident production.

The effectiveness of ESP in preventing these crashes has already been studied in several papers (ZOBEL et al., 2000; SFERCO et al., 2001; LANGWIEDER et al., 2003; AGA and OKADA, 2003; TINGVALL et al., 2003; UNSELT et al., 2004; BECKER et al., 2004). It is not worth reporting in-depth about their findings since each of these papers recalls the previous research results available at the time of publication. The last release even recalls the main issues related to ESP effectiveness (LANGWIEDER et al., 2004). Nevertheless, it is worthwhile mentioning here below some outstanding elements of these studies, and especially their different viewpoints.

Expected vs. Observed Effectiveness

Two of these studies addressed the expected effectiveness of ESP prior to the equipment of cars with such devices. The effectiveness is estimated in a two-steps process. First the number of ESP-pertinent injury or fatal crashes (skidding accidents or loss of control) is calculated from available accident databases. Then, a detailed examination of accident cases by experts states whether or not ESP could have had an influence on the sequential development of the crash, taking into account other key elements of the accident. SFERCO et al. came to the conclusion that in 18% of all injury accidents and 34% of all fatal accidents, ESP would have reduced the likelihood of an accident or avoided the accident altogether. LANGWIEDER et al. showed that at least 25% of injury crashes would be ESP-pertinent. The major benefit of ESP is expected in critical situations in bends where the driver attempts several steering wheel actions while skidding or in other situations where the driver does not apply the brakes.

The other studies addressed the observed effectiveness of ESP by comparing the accident rates of ESP-equipped cars versus others or by estimating the proportion of ESP-pertinent accidents for ESP-equipped cars and for other cars. The results depend on the initial assumptions, the availability of data, the effectiveness indicator, the study design, the methodologies used and the statistical techniques. AGA et al. found a 35% reduction in the single car accident rate and a 30% reduction in the head-on collision accident rate for ESP-equipped cars compared to similar unequipped cars in Japan. TINGVALL et al. found a 22% reduction in ESP-pertinent crashes for ESP-equipped cars in Sweden. UNSELT et al. estimated that, in Germany, ESP-equipped cars, when compared to the same DaimlerChrysler cars before systematic ESP equipment, had a 40% reduction in loss of control crashes resulting in a decrease in the overall injury accident risk of 16%. Finally, BECKER et al. calculated a 45% reduction in loss of control injury accidents if all cars were equipped with ESP in Germany (this estimate is even higher if only Volkswagen cars are taken into consideration).

¹ Loss of control is often assimilated to road departure. However, roadway departures can be split into two kinds of accidents: guidance problems (the car leaves the road without dynamic problems and is still controllable) and loss of control (the car's transversal acceleration is incompatible with the road grip and the vehicle becomes uncontrollable. Some loss of control crashes are also linked to blocked wheels during braking but these can be dealt with by ABS rather than by ESP).

² GIDAS: German In-Depth Accident Study

Exposed/Non Exposed Studies vs. Internal Case-Control Studies

Apart from the studies evaluating the expected effectiveness of ESP, the other studies used different methodologies to evaluate the observed effectiveness. The first methodology is a comparison of the accident rates of two car fleets, one composed of ESP-equipped cars and the other of similar unequipped cars. This is known in epidemiology as the exposed/non-exposed quasi-experimental design. Since the kilometrage is usually not available, the denominator of the rate is commonly the number of vehicles sold. The accident rate can be calculated for ESP-pertinent accidents only or for all types of accidents.

The second methodology consists of estimating the proportion of loss of control in crashes involving ESP-equipped and in crashes involving unequipped cars and of comparing these proportions. This is known as the internal Case-Control design. The methodology relies only on crashes data. The cases are ESP-pertinent crashes and the controls are non ESP-pertinent crashes. Statistical techniques used for comparisons may vary considerably between studies.

As a whole, even though most results do not include statistical confidence intervals, all studies conclude that ESP is highly effective and should contribute to considerable reductions in road injuries and fatalities in the coming years as the equipment rate of the European vehicle fleet continues to rise.

This assertion concerns Japanese, German and Swedish accident data because the evaluation studies were performed in these countries. Evidence is missing for other countries. Consequently, this paper proposes an evaluation of the effectiveness of ESP in terms of the reduction of injury accidents in France.

Method and Data

As in the ABS and ESP studies carried out in the past by EVANS (1998), KULLGREN et al. (1994) and TINGVALL et al. (2003), we use a method that refers only to accident data independent of exposure data. The exposed-not exposed method was not possible here since the calculation of accident rates requires either the constitution of ESP-equipped and unequipped car fleets and the

recording of their mileage and road accident involvement over several years (which is a costly and inappropriate design since accidents are rare) or a good estimation of the overall fleet currently on the road with and without ESP, for a selection of car makes and models. Furthermore, it would ideally require an estimation of the mileage driven by each fleet. Both information is not available to us.

Our method consists of 3 steps:

- The identification, in the French National injury accident census (Gendarmerie Nationale only), of accident-involved cars for which ESP equipment or non-equipment is known.
- The identification of accident situations for which we can determine whether or not ESP is pertinent (for example ESP is pertinent in loss of control accidents whilst it is not for cars pulling out of a junction).
- The calculation, via a logistic regression, of the relative risk of being involved in an ESP-pertinent accident for ESP-equipped cars versus non-equipped cars, divided by the relative risk of being involved in a non ESP-pertinent accident for ESP-equipped cars versus non-equipped cars. This relative risk is currently assumed to be the best estimator of ESP effectiveness.

First Step

In France, the identification of cars involved in an injury accident is not that easy. Cars are recorded in the national accident census via a code, the so-called CNIT code, which the police copies from the vehicle registration document. Unfortunately, 50% of the codes are not directly identifiable due to errors in the completion of the statistical form. Furthermore, for the remaining 50%, there is no bijection between the code and the determination of whether a car is or is not equipped with a given device. Consequently, instead of identifying whether a car, selected from the accident-involved cars is ESP-equipped, we had to choose a set of cars for which the information was easily accessible and then identify these cars in the accidents according to their make and model, which is easier via the CNIT. This data limitation led us to retain only one make and model: the Renault Laguna. There are two versions of this car. The Laguna 1 was produced in the late 1990s and early



Fig. 1: Renault Laguna 1

2000s without ESP (figure 1). In January 2001, Renault launched the Laguna 2, with ESP as standard equipment (figure 2). It was then possible to distinguish the two Lagunas in the accident census using the CNIT (make and model) and the first registration date.³

This choice has, of course, certain drawbacks. In particular, the Renault Laguna 2 is a newer car and benefits from other significant improvements such as Emergency Brake Assist, a tire pressure monitoring system and the well-known passive safety improvements, since it was the first car ever to be awarded 5 stars in the EuroNcap consumer tests. Furthermore, the mean age of accident-involved Laguna 2 cars is lower than the mean age of involved Laguna 1 cars for the study period (from 2000 to 2003). These limitations could have generated a bias in the estimation of ESP effectiveness. This issue will be addressed in the third methodological step.

We selected a sample of 1 356 Laguna cars involved in injury accidents occurring in 2000, 2001, 2002 and 2003 in France. These are all the Lagunas we were able to identify in the national accident census. We therefore had to assume that the residual unidentifiable Lagunas, due to errors in typing the car identification code, were randomly distributed among ESP-pertinent and non-pertinent accidents. These accidents are assumed



Fig. 2: Renault Laguna 2

to be very few as we did our utmost to identify all the Lagunas.

Second Step

The method requires the allocation of accidents into ESP-pertinent and non-pertinent accidents. We took this information from the national census by combining several variables such pre-accidental manoeuvre, number of vehicles involved, and type of obstacle. We ended up with a list of 40 accidental situations (table 1). We were not actually interested in the accidents per se, but rather the accident situations, the difference being that the accident situation is linked to a driver-vehicle unit (PAGE et al., 2004). A single vehicle accident has a single situation. In a two-vehicle accident, each driver has a specific accident situation corresponding to the circumstances in which he finds himself. For example in a crossing accident at a junction, the first situation corresponds to the user who pulls out of the intersection after stopping at a stop sign. The second situation corresponds to the driver with right of way who has to cope with a vehicle suddenly crossing his carriageway. This is the reason why we chose to build an accident situation list rather than an accident list.

For each accident situation, we stated whether it was ESP-pertinent and/or braking-pertinent, or neither ESP nor braking pertinent. We made this distribution on the basis of our expertise with respect to in-depth analysis of accidents investigated on-scene.

ESP-pertinent accidents are mainly single car accidents involving loss of control. On the other hand, there are two kinds of non ESP-pertinent accidents: those for which braking is pertinent and

³ Initially, we also kept other vehicles but had to consider the vehicle make and model as a confounder in the analysis. However the ESP variable (Equipped – Not equipped) was perfectly correlated to the model variable. Instead of dropping the variable Model, it was preferable to remove the other vehicles, otherwise the analysis would have been unstable.

those for which it is not. Because Emergency Brake Assist was the other main active safety innovation on Laguna 2 compared to Laguna 1, integrating braking-pertinent accidents in the sample of non ESP-pertinent situations could have generated a bias in the estimation of ESP effectiveness. We finally decided to limit non

ESP-pertinent accidents to a subset of accidents for which braking does not apply.

The influence of the Tire Pressure Monitoring system was assumed to be negligible and the influence of passive safety enhancements will be covered in the discussion section.

Type of accident situation	Relevant vehicle/driver function/action
Loss of control or guidance problem	
Single car accident. Loss of control or guidance problem on a straight road outside junction	ESP
Loss of control or guidance problem on a straight road outside junction. Collision with an opponent	ESP + Braking
Single car accident. Loss of control or guidance problem in a bend outside junction	ESP
Loss of control or guidance problem in a bend. Collision with an opponent	ESP + Braking
Single car accident. Loss of control or guidance problem at a junction	ESP
Accident involving a pedestrian	
Car confronted with a Pedestrian walking along the roadway	Braking
Car confronted with a Pedestrian crossing the roadway	Braking
Car confronted with a Pedestrian hidden by an obstacle	Braking
The driver is reversing and hits a pedestrian	
Car-to-vehicle accidents outside junctions	
Opposing vehicle to a vehicle that loses control in a bend	Braking
Opposing vehicle to the vehicle that loses control on a straight road	Braking
Rear-end accident. Striking car	Braking
Rear-end accident. Struck car	
Car changing lane and hit by a car driving in the same direction or in the opposite direction	
Car confronted with an obstacle	Braking
Overtaking car	Braking
Parking or parked car	
Car making a left turn or a right turn	
Car whose occupant opens his door	
Car making a U-turn or car crossing the road	
Car-to-vehicle accidents at junctions	
Car driver at fault in a round-about (left or right turn, insertion, others)	
Car driver not at fault in a round-about (left or right turn, insertion, others)	
Crossroads. Driver at fault going straight	
Crossroads. Driver turning left	
Crossroads. Driver turning right	
Crossroads. Driver going straight ahead confronted with driver going straight in the perpendicular direction	Braking
Crossroads. Driver going straight ahead confronted with driver turning left or right from a perpendicular road	Braking
Same road. Different directions. Car driver not at fault confronted with driver going straight	Braking
Same road. Different directions. Car driver not at fault confronted with driver turning left or right	Braking
Same road. Different directions. Car driver at fault confronted with driver going straight	
Same road. Different directions. Car driver turning right confronted with driver going straight	
Same road. Different directions. Car driver turning left confronted with driver going straight	
Same road. Same directions. Car driver at fault hitting another vehicle going straight	Braking
Same road. Same directions. Car driver not at fault going straight hit by another vehicle	
Same road. Same directions. Car driver hitting another vehicle turning right	Braking
Same road. Same directions. Car driver turning right hit by another vehicle	
Same road. Same directions. Car driver hitting another vehicle turning left	Braking
Same road. Same directions. Car driver turning left hit by another vehicle	
Car driver hitting another vehicle making a U-turn	Braking
Car driver making a U-turn hit by another vehicle	

Tab. 1: Accident situations and ESP-pertinent situations

Not surprisingly, the national accident census is a large database with a low level of detail. Consequently, for certain types of accidents, the allocation to the ESP-pertinent or non ESP-pertinent group is questionable. There might be some classification errors. Some single car accidents are not loss of control accidents but guidance problems. In some cases, the vehicle does not slide broadside but leaves the roadway controllable, from a dynamics point of view. The driver may fall asleep or not react for whatever reason (e.g. inattentive, hypo-vigilant, doing a secondary task, under the influence of alcohol, etc.) and the car goes off the road with no dynamic solicitation. These accidents are unidentifiable in the accident census and are amalgamated with loss of control accidents. We then assumed that the proportion of guidance problems in loss of control situations is negligible.

For pedestrian accidents and some car-to-car accidents (overtaking, car confronted with an obstacle, overtaking car, opponent to a car having lost control), it is assumed that the car driver did not take evasive action and consequently did not lose control through this evasive action. These latter accidents (loss of control due to an evasive action) are mostly classified as loss of control accidents. Some cannot nevertheless be identified as such in our database and are scattered in the other classes. Again, we assumed that they are rare events in these classes (PAGE et al., 2004). Consequently, we supposed that these situations correspond to non ESP-pertinent accidents.

Third Step

Effectiveness is highly dependent on the effectiveness indicator. We must therefore choose it carefully, according to available data. Concretely, in our study, the effectiveness E is estimated by (1).

$$E = 1 - OR = 1 - [(A \cdot D) / (B \cdot C)] \quad (1)$$

With OR, the odds ratio, A, B, C, D being the numbers of accidents with respect to ESP, as explained in table 2.

	ESP-equipped cars	Non ESP-equipped cars
ESP-pertinent Accidents	A	B
Non ESP-pertinent Accidents	C	D

Tab. 2: Distribution of accidents for the calculation of the odds ratio OR

After several assumptions, and noticeably the assumption that the accident sample is drawn randomly from the accident census, we can show that (e.g. HAUTZINGER, 2003):

$$OR = \frac{R_{AS}}{R_A} = \frac{\frac{R_{AS-S}}{R_{AS-NS}}}{\frac{R_{ANS-S}}{R_{ANS-NS}}} \quad (2)$$

with:

- R_{AS-S} is the risk of being involved in an accident where ESP is assumed to be pertinent for an ESP-equipped car.
- R_{AS-NS} is the risk of being involved in an accident where ESP is assumed to be pertinent for a non ESP-equipped car.
- R_{ANS-S} is the risk of being involved in an accident where ESP is assumed not to be pertinent for an ESP-equipped car.
- R_{ANS-NS} is the risk of being involved in an accident where ESP is assumed not to be pertinent for a non ESP-equipped car.

In other words, the odds ratio OR, formulated by (2), has a comprehensible interpretation. Assuming that ESP has no effect at all on accidents in which it is not assumed to be pertinent, (R_{ANS-S}/R_{ANS-NS}) is assumed to be equal to 1. This commonly supposes no driver adaptation to ESP with for example higher risk taking or higher driving speed. This assumption is confirmed, at least in the short term, by TINGVALL et al., who found no distortion in the proportion of impacting cars for ESP and non-ESP equipped cars in rear-end collisions.

Consequently, the odds ratio measures the relative risk of being involved in an ESP accident for ESP-equipped versus non-equipped cars.

In practice, table 2 only enables the calculation of the crude odds ratio, irrespective of potential confounders. The adjusted odds ratio is then estimated via a logistic regression. It enables confounders such as: Driver age and gender; Vehicle age and Year of accident (these two variables should solve the problem raised above, i.e. the age difference between Laguna 1 and Laguna 2); Pavement status (whether the pavement was dry or wet); Location of accident to be taken into consideration. No reliable information about seat-belt use was available.

Gender	Frequency	%
Female	141	24
Male	447	76
Total	588	100

Tab. 3: Distribution of the cars according to driver gender

Age	Frequency	%
18-24 years old	50	8.5
35-44 years old	259	44.1
45-54 years old	129	21.9
55-64 years old	77	13.1
65 years old and older	73	12.4
Total	588	100

Tab. 4: Distribution of the cars according to driver age

Vehicle age	Frequency	%
Less than 1 year old	114	19.4
1 to 2 years old	91	15.5
2 to 3 years old	77	13.1
3 to 4 years old	91	15.5
4 to 5 years old	98	16.7
Over 5 years old	117	19.8
Total	588	100

Tab. 5: Distribution of the cars according to car age

Pavement State	Frequency	%
Dry	477	81
Wet	111	19
Total	588	100

Tab. 6: Distribution of the cars according to the pavement state at the accident

Location	Frequency	%
Inside urban area	176	29.9
National Road	81	13.8
Secondary network	267	45.4
Others	64	10.9
Total	588	100

Tab. 7: Distribution of the cars according to the accident location

Year of accident	Frequency	%
2000	150	25.5
2001	182	30.9
2002	171	29.1
2003	85	14.5
Total	588	100

Tab. 8: Distribution of the cars according to year of accident occurrence

	ESP as standard equipment	No ESP	Total
ESP-pertinent accident situations	22	177	199
Non ESP-pertinent accident situations	71	318	389
Total	93	495	588

Tab. 9: Distribution of the cars according to their involvement in ESP-pertinent or non-pertinent accident situations

Results

Simple Statistics

The limitation of the accident situations to those related specifically to ESP and those related to neither ESP nor braking dramatically lowered the number of situations to be considered. We finally retained 588 out of the initial 1356 cars. Unfortunately, the small sample size can generate unstable coefficients in logistic regression and/or large confidence interval of the odds ratio. We will come back to this issue in the discussion section.

Tables 3 to 8 show the distributions of each confounder. For most of them, the distribution does not show cells sufficiently unbalanced to disturb the analysis.

Crude Odds Ratio

Table 9 displays the repartition of accident situations according to ESP equipment and pertinence.

From this table, we can calculate the crude odds ratio, $OR = (22 \times 318) / (71 \times 177) = 0.56$. We can also calculate the confidence interval of the odds ratio⁴ [0.46;1.29]. The effectiveness is then calculated by (1): $1 - 0.56 = 44\%$. The risk of being involved in an ESP-pertinent accident for ESP-equipped cars is 44% lower than the same risk for non-equipped cars. However, as expected, this result is not statistically significant because of the small sample size.

This first result has to be validated by a more sophisticated analysis taking possible confounders into consideration. This was done using logistic regression (table 10).

Logistic Regression

Logistic regression enables the estimation of the adjusted odds ratio and its confidence limits. The crude odds ratio is then adjusted by the values of the explanatory variables. The variable of greatest interest is, needless to say, the presence of ESP in the car. The other variables are taken into consideration as confounders (Driver Age and Gender, Pavement State, Accident Location) and

⁴ For a presentation of the computation of the confidence interval of the odds ratio, refer for example to BOUYER et al. (1995) or PAGE (1998).

also to counter the potential bias due to the limitation of data. For example, the bias selection due to the restriction of cars to Lagunas of different generations is countered by the integration of vehicle age and year of accident in the regression model.

It should be remembered that logistic regression requires the fixing of a reference point for each variable (i.e. one of the values of the variable), which is then used to explain the results across the entire variable. For example, the variable Driver Age is the explanatory variable at a reference point of 25-44 years of age. Thus the relative risk of accident involvement for drivers aged 18-24 is

Logistic Model (ESP-pertinent accident situations versus neither ESP nor Braking-pertinent accident situations)			
Number of observations: 588 ESP-pertinent cases : 199 / Non ESP-pertinent cases : 389 AIC : 651 SC : 734 -2 Log L : 613			
	Odds ratio	Min.	Max.
ESP			
ESP fitted in the car as standard equipment	0.57	0.25	1.30
<i>ESP not fitted in the car</i>	-	-	-
Driver Age			
18-24 years old	4.21	2.06	8.64
<i>25-44 years old</i>	-	-	-
45-54 years old	0.75	0.45	1.25
55-64 years old	0.46	0.23	0.89
65 years old and older	0.60	0.32	1.15
Gender			
Female	0.99	0.62	1.59
<i>Male</i>	-	-	-
Vehicle Age			
Less than 1 year old	0.74	0.3	1.81
1 to 2 years old	1.6	0.77	3.42
2 to 3 years old	1.2	0.58	2.49
3 to 4 years old	0.6	0.31	1.30
4 to 5 years old	1.10	0.55	1.30
<i>More than 5 years old</i>	-	-	-
State of the pavement			
Wet	2.67	1.6	4.29
<i>Dry</i>	-	-	-
Location			
National Roads	5.85	2.88	11.89
Secondary network	6.36	3.57	11.32
<i>Inside urban areas</i>	-	-	-
Others	13.8	6.5	29.23
Year of the accident			
2000	-	-	-
2001	0.83	0.49	1.40
2002	1.02	0.57	1.88
2003	0.48	0.21	1.09
Percent of concordant Pairs : 78%/Somers's D = 0.57/ Gamma = 0.57/ Tau-a = 0.25 / c = 0.78			

Tab. 10: Results of the logistic regression

greater than for 25-44 year-olds (odds ratio of 4.2) and decreases for 45-54 year-olds (odds ratio between 0.75 according to the model). Overall, for this explanatory variable, we can say that the relative risk of accident involvement decreases with age. The reference points for each explanatory dimension are highlighted in italics in table 10.

The adjusted odds ratio correspondent to ESP, 0.57 and its confidence interval [0.25;1.30], are not very different from the crude odds ratio. Based on the crude and on the adjusted odds ratio, we can then confirm that ESP is apparently very effective (43% reduction in the risk of being involved in an ESP-pertinent accident for ESP-equipped cars versus non-equipped cars). However, this estimation is not statistically significant and holds only for our selection of cars: the Renault Laguna.

Other results are consistent with the literature. Youngsters have a higher risk of being involved in loss of control accidents. Females have a similar risk of loss of control than males; wet pavement is associated with a higher risk of loss of control compared to dry roads. National and secondary and tertiary road networks are associated with a higher risk of loss of control compared to urban areas. Finally, accidents occurring in 2003 are also associated with less loss of control. This can be explained by the incredible increase in road safety on French roads starting in the later months of 2002, partially due to lesser driving speeds. We will talk about this issue further in the discussion section.

Discussion

All studies available so far conclude that ESP is highly effective and should contribute to considerable reductions in road injuries and fatalities on European roads in the coming years as ESP equipment rate is rapidly growing (e.g. more than 50% of newly registered cars in Germany, up to 30% in France). As there was no evidence of such effectiveness in France, this paper addresses this effectiveness issue in France.

To estimate ESP effectiveness, we used a method that only refers to accident data irrespective of exposure data. The method consisted of 3 steps. First we selected makes and models of cars involved in injury accidents in France, from year 2000 to year 2003, for which the determination of whether or not the car is fitted with ESP is possible.

It led us to conserve only Renault Laguna cars. Laguna 1, released before January 2001, was not equipped with ESP whereas Laguna 2, released after January 2001, was ESP-equipped.

Then we identified 40 various accident situations and also split these accident situations into four groups according to whether they were ESP-pertinent, Braking-pertinent, ESP and Braking-pertinent or neither ESP nor Braking-pertinent. The identification of braking as a potential avoidance or injury mitigation manoeuvre is necessary because the Laguna 2 is also equipped with emergency brake assist that could also be effective and act in combination with ESP. As we wished to measure only the effectiveness of ESP, we had to withdraw the braking-pertinent accident situations from the analysis. Finally, we ended up with a sample of 588 accident situations, 199 being ESP-pertinent and 389 being non ESP-pertinent.

The estimation of the effectiveness of ESP was carried out using the adjusted odds ratio, which can be interpreted as the relative risk of being involved in an ESP-pertinent accident for a Laguna 2 fitted with ESP versus Laguna 1 non fitted with ESP, divided by the relative risk of being involved in a non ESP-pertinent accident for a Laguna 2 fitted with ESP versus a Laguna 1 not fitted with ESP. This relative risk is assumed to be the best estimator of the ESP effectiveness.

A series of implicit or explicit assumptions were made during the course of the evaluation and a few difficulties also arose from the data and method.

- The effectiveness indicator, i.e. the odds ratio, supposes that there is no driver adaptation to ESP, and especially that the non ESP-pertinent accidents are not affected by the presence of ESP. This is not a major assumption as ESP is relatively badly understood (according to Bosch, only 30% of drivers know what ESP is) and should not lead to risk compensation, at least by now. However, the method itself is based on this assumption and therefore it should not be ignored.
- The effectiveness depends heavily on the breakdown of accident situations into ESP-pertinent and non-pertinent situations. Apart from classification errors due to the use of imprecise national accident census, we took care to withdraw accident situations that could be pertinent to another safety system such as

emergency brake assist. On the other hand, this resulted in a small accident situations sample that reduced the stability and the accuracy of the effectiveness estimation (large confidence interval). A larger sample should be sought. In time, the number of identifiable cars in the national census will grow and we will be able to update our result.

- The effectiveness holds only for one make and model of the M2 segment: the Renault Laguna. Other cars were withdrawn from the analysis because make and model were perfectly correlated with ESP equipment. This does not mean that the effectiveness holds for other cars and other segments.

We should seek for ways to integrate more cars into the sample while taking into consideration the differences in car makes and models. Once again, the increase in sample size and the variety of identifiable cars could be of great help in the future.

On the other hand, we took care in the logistic regression to consider vehicle age and the year of the accident which counter the fact that the compared cars are the same vehicle from different generations for which ESP comes as a new device at a certain point of time.

- That raises another crucial issue. The cars that we have compared, although identical in make and model, are completely different thanks to the dramatic improvements on the Laguna 2 concerning active and passive safety. The presence of tire pressure monitoring is not considered as having an enormous influence on accident involvement and the presence of the emergency brake assist on Laguna 2 only has been dealt with via the accident types. But the problem of passive safety improvements still remains. It is natural (and proven) to consider that the likelihood of sustaining injuries in Laguna 2 is dramatically reduced compared to Laguna 1. The only problem that arises is to state whether or not this reduction is identical for ESP-pertinent and non-pertinent accidents. If it is the case, no bias is generated in the analysis. We have not tested this hypothesis so far. We implicitly considered that it is true. Further work should address this important matter.

Similarly, ESP systems fitted in cars are not identical. ESP configuration depends on the suppliers as well as the instructions given to

suppliers by the car manufacturers. It is impossible to state from our analysis which ESP system provides better results.

- We evaluated the short-term effect of ESP. The long-term effect might be different as drivers increase their awareness of ESP benefits. This could generate a driver adaptation and then a likely reduction of the ESP effect. Once again, an update of the study within a few years would eventually highlight this issue.
- TINGVALL et al. studied the effect of ESP for different car sizes and different weather conditions. As our sample size is small, we have not been able to do so. We highlighted an overall effect while being unable to attribute this effect to certain types of cars or certain accident situations. We have recently launched a research program to investigate in-depth accidents involving newer cars equipped with as many safety systems as possible in order to add qualitative information to the statistical analysis. In the coming months, we should be able to complete this overall picture of the effect of ESP with accurate in-depth analysis of a selection of accident cases and evaluate what the accident mechanisms are behind this effectiveness. Simulator on track experiments will also provide us with some insights into the influence of ESP.
- The analysis focused on injury accidents only (injury accidents and fatal accidents combined). As mentioned in the introduction, loss of control accidents account for approximately 25% of injury accidents and 40% of fatal accidents in Germany and in France. If we assume that the estimated effectiveness is similar for injury and fatal accidents, there should be a greater overall benefit for fatalities than for injuries. If 100% of the fleet was equipped with ESP, we would expect a 16% reduction in overall fatalities and a 10% reduction in overall injuries.

Now we must consider whether the spectacular evolution of road traffic safety in France since June 2002 can be attributed to ESP. For the year 2003, the figures show a 20.3% decrease in injury accidents, a 20.9% decrease in road deaths and a 15.9% decrease in road accident injuries compared to year 2002.

This situation is exceptional. Such a decrease has only been seen twice before in France; in 1974,

after the generalized introduction of speed limits and compulsory seat-belt use and, to a lesser extent, in 1978, with the introduction of a law allowing preventive alcohol testing of car drivers. The European countries for which statistics are available do not show a similar evolution in 2003. The situation is somewhat contrasted (-6% in Germany and +6% in Holland for example for the first 7 months of the year, but -19% in Finland and -10% in Sweden for the first 8 and 5 months of the year respectively). In the absence of comprehensive models to explain the road safety situation in France in the short and medium terms, road safety watchdogs in France impute this reduction to 3 main groups of factors:

- The declaration by the head of state on the 14th July 2002 that road safety was now a national issue.
- Unprecedented media coverage of road safety following this declaration and reinforced in September 2002 with the organization of a national road safety congress.
- The preparation of the 12th June 2003 road safety law, which is predominantly repressive (harsher fines and prison sentences for serious infractions, probative driving license for young drivers, etc.).

These elements contributed to a short-term increase in road safety awareness, an increase in traffic policing (+15% for alcohol testing and more speed controls in 2003), a dramatic increase in seat-belt use (seat-belt use by car front occupants is now 97% in rural areas and 90% in urban areas compared to 95% and 80% respectively in 2002), and finally to a reduction of driving speeds (exceeding speed limits by 10km/h decreased from 35% to 25%) and alcohol consumption when driving.

Experts are nevertheless curious as to the long-term effects of this combination of positive factors. The recent arrival on the roadside and in everyday conversation of automatic speed cameras, the visible element of the automatic control-sanction chain will undoubtedly help to maintain this behavioral moderation and hence produce long-term effects.

Even though it is generally acknowledged that infrastructure and vehicle actions have not produced such dramatic short term effects, it is obvious that they have a long-term structural effect

which complements and encourages short-term behavioral actions. In particular, it is right to say that ESP is very efficient in reducing loss of control accidents. Our study showed that ESP could effectively reduce these accidents by 43%. As earlier stated, if 100% of vehicles were equipped with such a device, the observed effectiveness would be a 16% reduction in fatalities. But the equipment rate is much lower than 10% in the current fleets, considering all car ages. ESP is thus assumed to have saved, at most, just a few percent of the fatalities, considerably less than the 20% observed in France in 2003. ESP is consequently definitively not the cause of the increase of safety in France over the last two years. Most probably, changes in driver behavior and, as a long-term effect, the progress in on-board protection are the main causes of such a success.

Nevertheless, as ESP efficiency is very high and as the equipment rate is growing rapidly, ESP will definitely be a major contribution to further reductions in the road toll. It has already proven effectiveness and should be considered as a major safety device in the coming years, especially in combination with passive safety devices, for example pretensioners, load limiters and airbags, which have also proven a very high efficiency (-80% of fatal thoracic injuries) and with other active safety devices.

From a purely research perspective, our ambition is now to go beyond the evaluation of one system independently of the others, to overcome the methodological difficulties and assess the effectiveness of passive and active safety systems acting in combination with one another.

Acknowledgments

The authors also like to warmly thank Richard Driscoll (CEESAR) for his careful reading, remarks and English editorial comments.

References

- AGA, M., OKADA, A. (2003): Analysis of vehicle stability control (VSC)'s effectiveness from accident data. ESV paper 541. 18th ESV Conference, Nagoya, 2003
- BAR, F., PAGE, Y. (2002): An empirical classification of lane departure crashes for the identification of relevant counter-measures. 46th AAAM Conference, Septembre 2002, Tempe, AZ
- BECKER, H., BUSCH, S., ZOBEL, R., (2004): Methods for the evaluation of primary safety measures by means of accident research. FISITA Conference, Barcelona, 2004
- BOUYER, J., HÉMON, D., CORDIER, S., DERRIENNIC, F., STÜCKER, I., STENGEL, B., & CLAVEL, J. (1995): *Epidémiologie, principes et méthodes quantitatives*. Paris, France: Les éditions INSERM
- EVANS, L. (1998): Antilock brake systems and risk of different types of crashes in traffic. ESV paper 98-S2-O-12, 16th ESV Conference, Windsor, 1998
- HAUTZINGER, H. (2003): measuring the effect of primary safety devices on accident involvement risk of passenger cars. Some methodological considerations. Internal note. European SARAC project
- KULLGREN, A., LIE, A. TINGVALL, C. (1994): The effectiveness of ABS in real life accidents. ESV paper n° 94-S4-O-07, 15th ESV Conference, Munich, 1994
- LANGWIEDER, K., GWEHENBERGER J., HUMMEL T. (2001): Benefit Potential of ESP in real accident situations involving cars and trucks. 18th ESV Conference, Nagoya, 2003
- LANGWIEDER K., GWEHENBERGER J., HUMMEL T. (2004): International field experiences with electronic stability program (ESP) in cars. FISITA Conference, Barcelona, 2004
- Le COZ, J.-Y., PAGE, Y. (2003): Démarche accidentologique et sécurité des véhicules. *Revue de la Gendarmerie Nationale*. N° 207, Juin 2003
- PAGE, Y. (1998): Un exemple d'application de la régression logistique à l'évaluation d'une mesure de sécurité routière. Observatoire National Interministériel de Sécurité Routière
- PAGE, Y. (1998): Utilisation de l'odds ratio comme mesure du risque relatif. Application à l'estimation du sur-risque des véhicules neufs versus les véhicules anciens. Note interne. Centre Européen d'Études et de Sécurité et d'Analyse des Risques. Nanterre

- PAGE, Y. (2000, 2001): Éléments de statistiques appliqués à la Sécurité Routière, ENSERR Report and LAB report.
- PAGE, Y., DRISCOLL, R., Le COZ, J.-Y., HERMITTE, T. (2004): Combination of a statistical and a case-by-case approach for accident situations classification. 30th FISITA World Automotive Congress. Barcelona, May 2004.
- SFERCO, R., PAGE, Y., Le COZ, J.-Y., Fay, P. (2001): Potential effectiveness of the Electronic Stability Programs (ESP) – What European field studies tell us? 17th ESV Conference, Amsterdam, 2001
- TINGVALL, C., KRAFFT, M., KULLGREN, A., LIE, A. (2003): The effectiveness of ESP (Electronic Stability Programme) in reducing real life accidents. ESV Paper 261. 18th ESV Conference, Nagoya 2003
- UNSELT, T., BREUER, J., ECKSTEIN, L., FRANK, P. (2004): Avoidance of "loss of control accidents" through the benefit of ESP. FISITA Conference, Barcelona, 2004
- ZOBEL, R., FRIEDRICH, H., BECKER H. (2000): Accident research with regard to crashworthiness and crash avoidance. Vehicle Safety Conference 2000, London

Session: Injury Prevention and Mechanisms

R. Schubert, T. Illert, H. Zwipp

M. Shimamura, H. Ohashi, M. Yamazaki, K. Okamura

S. I. Oni

R. Schubert, I. Illert, H. Zwipp
 Technical University of Dresden, Department of
 Accident and Reconstructive Surgery, Dresden,
 Germany

Foot Injuries in Car Occupants

The improvement of passive car security devices led to a reduction of injuries, especially of the head, the neck and the torso mainly due to the airbag function. The passenger's foot and ankle could not profit from this development. Some investigators even reported a progression of leg injuries (1).

In this study, we investigated a current collective of patients with foot and ankle fractures or severe soft tissue injuries in relation with defined crash parameters. Special interest was paid to the car's footwell.

Patients and Methods

We analyzed retrospectively a data set of car accidents, collected by the accident research team of the Technical University of Dresden, regarding the passengers foot and ankle injuries. The investigated period took place from July 1999 to December 2002. The data collection was followed by a spot check with following criteria: car accident with injured people, during a predetermined time and area. The observed area covered 2575 square kilometres with 925,000 inhabitants. 500 to 3000 data items were collected for each accident. Afterwards, the accidents were virtually reconstructed by a specially designed computer program. In this study, we included all front seat passengers of four wheel cars (inclusive buses and lorries), which suffered a foot or ankle injury directly due to the accident with an AIS (abbreviated injury score) ≥ 2 . Exclusion criteria were a rollover or an extricated passenger.

AIS (abbreviated injury score) for lower extremity (2):

AIS 1 – toe fractures, minor to moderate soft tissue injury

AIS 2 – foot fractures, except severely dislocated or comminuted fractures (compare AIS 3), severe soft tissue injuries

AIS 3 – dislocated fractures of the ankle with a Volkmann triangle, Chopart-Lisfranc

dislocation fractures, most severe soft tissue injury, traumatic amputation

These criteria were fulfilled by 2221 injured people from a total of 5218 persons involved in the recorded car accidents. For clearer demonstration purposes, we divided the foot in its anatomic regions: ankle, hind-foot, mid-foot and fore-foot. We investigated the main impulse direction of the car accident, the change of speed (Δv in km/h), the EES (energy equivalent speed in km/h), the degree of footwell intrusion and the injury causing parts.

Results

Forty persons suffered in 34 accidents a foot and/or ankle fracture with an AIS ≥ 2 , corresponding to 1.8 percent of all registered injured persons. The mean age was 41.7 years (range 17-75 years). Men were injured three times more than women (31 men, 9 women). These 40 persons had, all in all, 49 distinct foot and/or ankle fractures. The distribution of these injuries is shown in figure 1.

33 persons were injured as drivers, 7 as passengers. 10 patients had a polytrauma, of whom 6 died.

5 patients had series fractures, 4 patients had fractures on both feet. We saw open injuries in 4 cases. The outer foot was as often injured as the inner.

All cars were equipped with belts, 8 patients were not belted. 8 cars had an airbag, in 7 cases the airbag was activated. We observed 12 accidents between two cars and 22 accidents between a car and a solid obstacle like trees or buildings.

We recorded 4 different accident places (figure 4).

The accidents were caused by frontal crashes in 93 percent of the cases: The main impulse direction came from 11h in 20 percent, 12h in 63 percent and 1h in 10 percent.

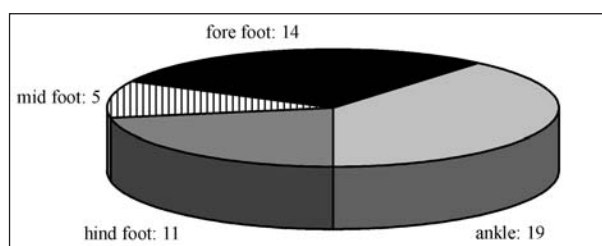

Fig. 1: Distribution of fractures and luxations to the anatomic regions of foot (n = 49)



Fig. 2: Calcaneus fracture, delta-v 20km/h, small car type



Fig. 3: Talus fracture, delta-v 75km/h, small car

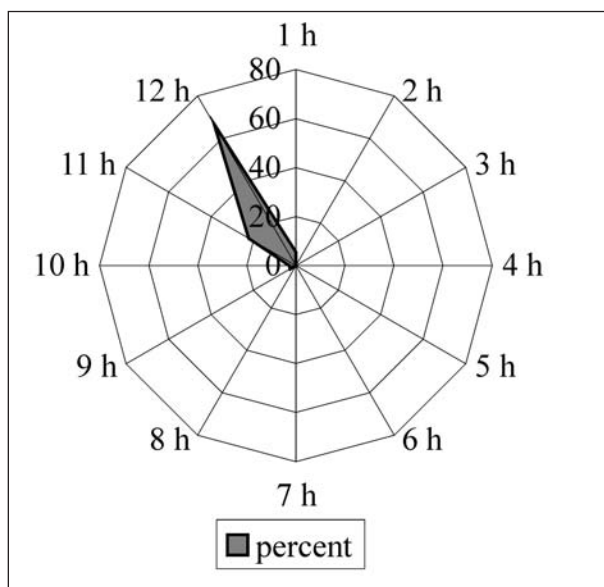

Fig. 5: Main impulse direction

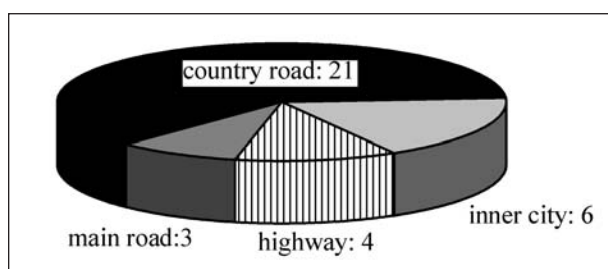

Fig. 4: Place of accident (n = 34)



Fig. 6: Frontal crash (car of compact class type, main impulse direction from 12h)

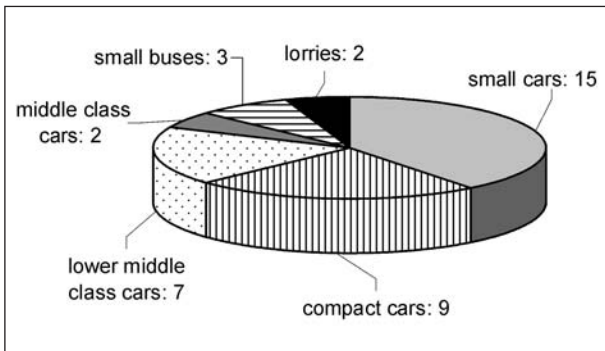

Fig. 7: Car types (n = 38) in which patients suffered by foot and ankle fractures

The noticed foot/ankle fractures happened in 38 cars (distribution see figure 7). The main age of the cars was 8 years, 7 cars were older than 10 years.

We saw no different in delta-v and EES-levels between the different foot/ankle anatomic regions (see figure 8).

The footwell intrusion was measured in different regions of the car's body. There is a trend to higher intrusion levels in sector L1-left in ankle- and hind-foot fractures (see figure 9).

High intrusion levels seemed to produce more often ankle and hind-foot fractures than mid- and

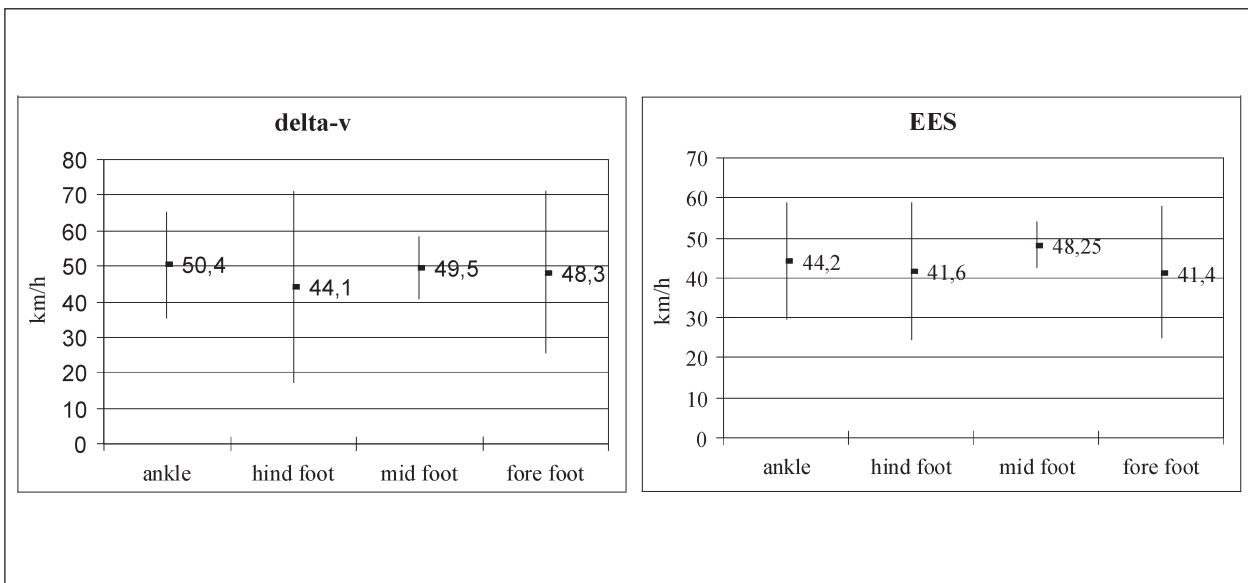

Fig. 8: Delta-v- and EES-level assigned to injured foot regions

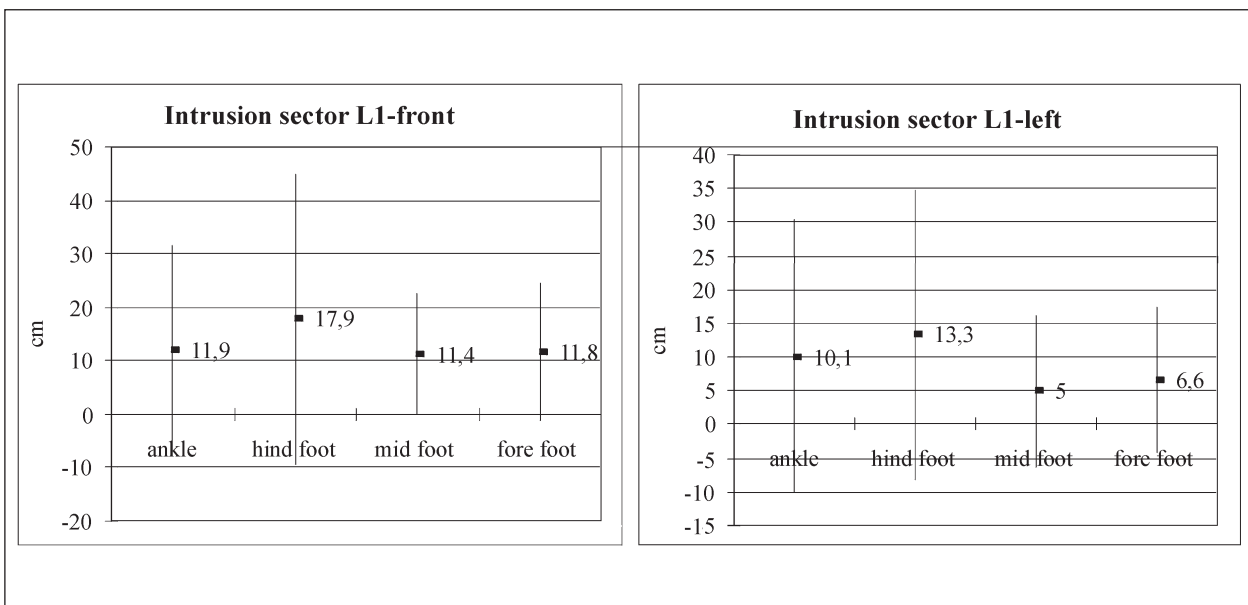

Fig. 9: Footwell intrusion sector L1-front and L1-left assigned to injured foot regions

fore-foot fractures. In cars with low footwell intrusion ($\leq 10\text{cm}$) three of 20 injuries were AIS 3-



Fig. 10: Typical accident mechanism with squeeze of the foot. Man, 42 years, car of lower middle class; death due to ruptur of liver and spleen; fractures of 2nd to 4th toe, severe soft tissue injury of right foot. Footwell intrusion in sector L1 front of 30cm, in sector L2 front of 20cm, delta-v 75km/h

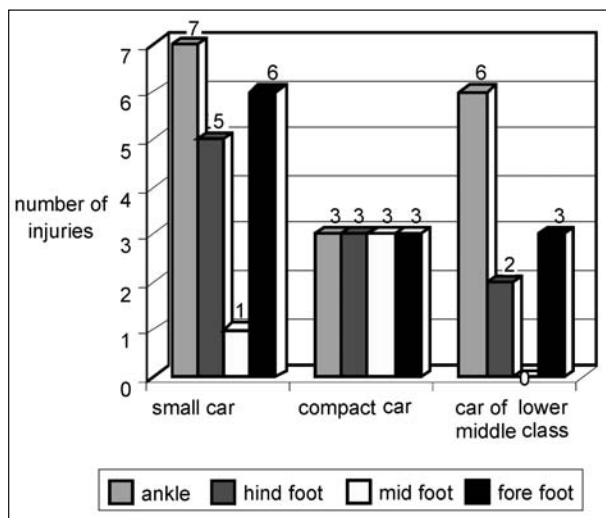

Fig. 11: Foot injuries assigned to different car classes

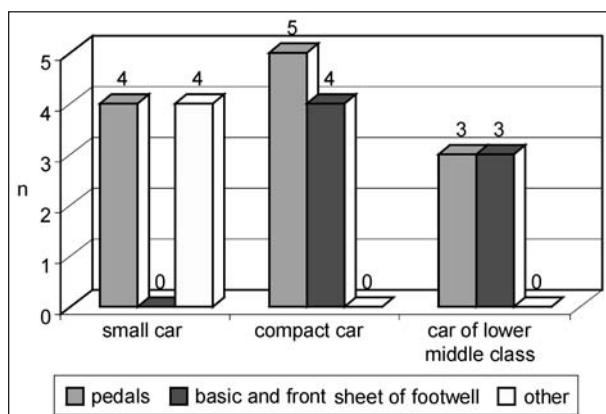

Fig. 12: Injury causing parts in different car types

injuries, but in cars with high footwell intrusion ($\geq 40\text{cm}$) 7 of 14 injuries were AIS 3-injuries.

We investigated the frequency of foot/ankle fractures in different car types and found a tendency of more frequent ankle injuries in small cars and cars of lower middle class (see figure 11).

The fractures mostly were caused by the pedals (see figure 12).

Conclusions

Foot/ankle fractures are seldom injuries (1.8 percent of injured persons). They are a typical drivers injury (driver : passenger = 4,5:1). Often we see these fractures in patients with polytrauma (n=10 of 40, 6 patients died). Foot/ankle fractures mostly happen in frontal crashes in cars of small dimension. High intrusion levels seem to produce more often ankle and hindfoot fractures than mid- and fore-foot fractures. The fractures are mostly caused by the pedals.

References

- 1 A. R. BURGESS, P. C. DISCHINGER, T. D. O'QUINN, C. B. SCHMIDBAUER: Lower Extremity Injuries in Drivers of Airbag-Equipped Automobiles: Clinical and Crash Reconstruction Correlations, The Journal of Trauma, Williams & Wilkins, 1995
- 2 M. RICHTER, H. THERMANN, B. WIPPERMANN, D. OTTE, H. E. SCHRATT, H. TSCHERNE: Foot Fractures in Restrained Front Seat Car Occupants: A Long Term Study over Twenty-three Years, J Orthop Trauma, 2001

M. Shimamura, K. Okamura
Institute for Traffic Accident Research and Data
Analysis, Tokyo, Japan

H. Ohashi, M. Yamazaki
Tukuba Traffic Accident Investigation Office,
Institute for Traffic Accident Research and Data
Analysis, Japan

In-Depth Study of Front Seat Occupants in Accidents in Relation to Seat-Belt Use of Rear Seat Passengers

Abstract

Sedan type vehicles in which adult rear seat passengers were present and which were involved in frontal collisions were investigated, and the influence of unbelted rear seat passengers on the injuries of front seat occupants was studied. Unbelted rear seat passengers move forward during impact. It was observed that there were not only cases in which front seat occupants sustained injuries caused by direct contact with rear seat passengers, but also cases where front seat occupants received severe injuries due to additional force from rear seat passengers, either impacting directly or indirectly as a result of deformation of the front seat. Severe injuries of front seat occupants were observed in the latter cases. This research validates the importance of seat-belt use for rear seat passengers, not only to protect themselves but also to mitigate injuries of front seat occupants.

Introduction

Seat-belt use of front seat occupants is increasing yearly, and has reached over 90% for drivers and around 85% for front seat passengers. Recently, the reduction of fatalities in traffic accidents has been remarkable. One of the reasons for this is thought to be the increase in seat-belt use. On the other hand, seat-belt use of rear seat passengers has not increased and the ratio is no more than 20% [1].

The fatality rate of rear seat passengers in accidents is lower than that of front seat occupants, both drivers and front seat passengers, though fatalities of rear seat passengers are almost

half that of front seat passengers and account for approximately 7% of total fatalities in four-wheel vehicles [1]. Occupants in vehicles that are involved in frontal collisions are impelled towards the front of the vehicle, and in the event of such a hazard, indications are that unbelted rear seat occupants tend to collide with the front seat or traverse the front seat, as a result of which they receive severe injuries due to collision with the instrument panel or windshield glass, and in some cases sustain fatal injuries due to ejection from the vehicle. Consequently, some research has been done on the effectiveness of seat-belts for rear seat passengers [2-5]. Results show that rear seat-belt use is effective in reducing passenger injuries, and that wearing seat-belts should therefore be imperative for rear seat passengers, too.

Some countries have made rear seat-belt use mandatory. Australia became the first country to enact legislation for rear seat-belt use, in Victoria in 1971 [6], followed by Germany in 1984, Canada in 1986, the UK in 1991 and Singapore in 2002. In fact, an increasing number of countries are demanding all occupants to wear seat-belts. However, mandatory seat-belt use for rear seats has been difficult to instigate in Japan. Reasons for this are the low rear seat occupancy rate and low fatality rate for rear seat passengers.

Indications are that unbelted rear seat passengers sometimes cause worse injury for front seat occupants [7]. On analyzing, from Japan's statistical accident data, head-on and rear-end collisions of sedan cars in which all passengers were injured, it was found that the number of fatally or seriously injured front seat occupants could be reduced by around 25-28% if unbelted rear seat passengers became accustomed to wearing seat-belts [1]. Such results indicate the importance of rear seat-belt use also in reducing injuries to front seat occupants.

However, the analysis of statistical accident data did not reveal the kind of injuries sustained by front seat occupants or how the movements of rear seat passengers affected the injuries of front seat occupants. Impact tests were carried out with anthropometric dummies, though the trajectory of a dummy might be different from that of a human being because of lower degree of freedom of movement of the dummy.

The aim of this research is to ascertain the injuries of front seat occupants based on in-depth accident

data and also to investigate the influence of the movements of unbelted rear seat passengers on those injuries. Although a variety of accident and vehicle data was available, they were not necessarily sufficient for the purpose of this analysis. It is difficult to analyze injury mechanisms statistically. However, since it is considered possible to compare the postulated relationships between injury patterns and occupant movements with the in-depth accident data, the frequency and the severity of injuries relating to rear seat passengers were studied.

Method and Data

Postulated Movements of Rear Seat Passengers and Injury Mechanisms of Front Seat Occupants

Unbelted rear seat passengers move forward in a vehicle in a frontal collision. Generally, since there are front seats in front of rear seat passengers, these are the first vehicle parts with which the rear seat passenger collides. The following are modes of movement of a rear seat passenger depending on the impact severity and passenger seating position.

- Mode I: Rear seat passenger impacts a front seat and stops moving (including cases where a front seat deforms).
- Mode II: Rear seat passenger travels forward over the front seat (including cases where a front seat deforms).
- Mode III: Rear seat passenger passes between the driver's seat and passenger's seat resulting in torsional deformation of the front seats (this mode is typical for a center seat passenger).

Modes of movement were determined from the following information in investigated data and photographs: the imprinted marks on front seats, instrument panel and windshield glass, and deformation of front seats.

Front seat occupants and rear seat passengers move forward independently when a vehicle receives a frontal impact. After the forward movement of front seat occupants is stopped by force of restraint, they can be moved further due to the influence of rear seat passenger movement behind them. When front seat occupants receive additional injuries related to rear seat passenger movement, those injuries are characterized by the following patterns:

- Pattern A: Injuries appearing at the contact area due to direct collision of rear seat passengers with front seat occupants.
- Pattern B: Injuries caused by collision with vehicle parts as a result of forward movement accelerated either by direct contact with forward-moving rear seat passenger or force from front seatback impacted by rear seat passenger.
- Pattern C: Injuries caused mainly by pressure from front and back.

In the accident investigations, the injury source of pattern A is usually recorded as other occupants. Sources of injury similar to pattern B or C are recorded as vehicle parts that were impacted directly, and no information is reported if rear seat passengers had an influence. Therefore, in this research, injuries were classified as patterns A – C by considering movements of both front seat occupants and rear seat passengers. For instance, in the case of direct contact of rear seat passengers with front seat occupants, the injuries are categorized as pattern A if injuries are seen at the point of direct contact, but if injuries are observed in other areas, those injuries are categorized as pattern B or C. Next, in the case of belted front seat occupants who are pushed forward by seatbacks, such injuries can be categorized as pattern C if they are observed along the seat belt path, and if injuries are observed in other areas those injuries can be categorized as pattern B.

In-Depth Accident Data

ITARDA (Institute for Traffic Accident Research and Data Analysis) was established in 1992 for the purpose of investigating data and analyzing traffic accidents comprehensively and scientifically. ITARDA established an accident investigation office in the suburbs of Tokyo, and is continuously collecting accident data from approximately 300 cases per year. Over 2700 accidents were filed up to the end of 2002. At accident sites, the following items relating to vehicles are recorded: specifications of vehicles and equipment, damage status, deformation areas and volume, and other essential information. Vehicle movements are analyzed based on the recorded information, vehicle deformation is classified as CDC code according to SAE J224, and impact severity is evaluated as BEV (Barrier Equivalent Velocity) or delta-V. Seat-belt use is determined by compiling

the following information: imprints on seat-belt devices, vehicle impact severity, vehicle parts impacted by occupants and injury of occupants. Injury of an occupant is classified by AIS 90 code based on the medical diagnosis by physicians, and injury sources are determined by compiling the following information: deformation or impact marks remaining on vehicle parts, location of injury and injury patterns on occupants as well as occupant kinematics.

In this research, vehicles analyzed were the sedan type with rear seats that were involved in frontal collisions recorded in 1993–2002 accident files. Frontal collision was determined by the horizontal impact zone of CDC code F, and impact angle was 10–02 o'clock. Station wagons or commercial vehicles were included in the analysis if they were derived from sedan passenger cars. But vehicles with major deformations, vehicles involved in multiple collisions and vehicles that hit vulnerable road users were excluded.

Vehicles with rear seat passengers were 142 in total, and vehicles in which at least one adult rear seat passenger aged 16 years or older was present were 104. The number of adult rear seat passengers was 141. Of the 141 rear seat passengers, 52 were seated on the right, in the back of the driver's seat*, 78 on the left, in the back of the front passenger's seat, and 11 in the middle. There were 8 belted passengers, 123 unbelted and 10 unknown. Since a child weighs much less than an adult, the influence on front seat passengers is considered so small that this research analyzed only the movement of unbelted adult rear seat passengers.

Results

Moving Area of Rear Seat Passengers

The correlation between seating locations and moving area of rear seat passengers is shown in table 1. There are 29 cases with no evidence of contact with the vehicle at all. It was found that 19 rear seat passengers moved forward beyond the front seats: 7 hit the windshield glass, 7 the instrument panel, and 5 the seating zone of front seat occupants. 5 out of the 19 rear seat occupants were seated in the middle.

Rear seat Moving area	Left side		Middle		Right side		Total
	Fore	Diag - onal	Fore	Diag - onal	Fore	Diag - onal	
Windshield	3	1	0	2	0	1	7
Instrument p.	1	2	0	3	1	0	7
Seating zone	2	2	0	0	1	0	5
Front seat	41	7	0	6	34	5	93
No contact	19		0		10		29
Total	78		11		52		141

("Fore" indicates the number of cases in which a rear seat passenger impacted the seat in front, and "Diagonal" indicates the number of cases in which a rear seat passenger made contact with both front seats. Seating zone means seating area in front of the seatback of a front seat.)

Tab. 1: Seating locations and moving areas

Next, the direction of movement of rear seat passengers was analyzed. There were 6 cases in which the right rear seat passenger contacted the left front seat diagonally, and 12 cases where the left rear seat passengers impacted the right front seat. Among 14 rear seat passengers who moved forward beyond the front seats and who were not seated in the middle, 6 moved forward and made contact with the front seat diagonally opposite to them.

Because none of the rear seat passengers moved forward beyond the front seats among passengers who wore seat-belts or whose seat-belt use was unknown, 123 of unbelted rear seat passengers were analyzed in the following sections.

Movements of Unbelted Rear Seat Passengers and the Injuries of Front Seat Passengers

Movement modes of rear seat passengers are shown in table 2. Excluding 22 cases in which no imprints from contact were observed, mode II and mode III accounted for 6 and 13 cases respectively. The remaining 82 cases were accounted for by mode I, and 18 out of the 82 mode I cases impacted the front seat diagonally opposite to them.

Next, the cases where injuries of front seat occupants appeared to be influenced by rear seat passengers were extracted by excluding the following cases: cases where no corresponding front seat occupants were present, cases where front seat occupants received no injury, and cases in which it was considered to be absolutely no rear seat passenger influence even though injury was

* It should be noted that vehicles run on the left side of the road in Japan, and that the driver is seated on the right of the vehicle and the front passenger on the left.

		Rear seats			Total
		Left	Middle	Right	
No contact observed		15	0	7	22
Mode I	Fore	35	0	29	6
	Diagonal	7	6	5	18
Mode II		6	0	0	6
Mode III		5	5	(Note 1) 3	13
Total		68	11	44	123
(Note 1: There were 2 cases in which rear seat passengers made contact with the seat in front and slid after collision.)					

Tab. 2: Movement modes of unbelted rear seat passengers

sustained. Table 3 contains a detailed list of 11 typical cases, in which mode I cases appear the most frequently. Two cases of model I are introduced here as examples.

Firstly, in case No. 2 in table 3, which is classified as mode I, the vehicle's BEV (Barrier Equivalent Velocity) measure of impact severity was approximately 45km/h. The unbelted passenger seated in the left rear seat contacted a front seat, and caused a large deformation of the front seat whose seatback bent forward, though no forward movement beyond the front seat was observed (see figure 1). The belted passenger who was sitting in the left front seat sustained a frail chest with lung contusions (AIS 4). There was a possibility that the severe rib fractures were related to the additional force of the rear seat passenger acting through the seatback.

In case No. 4 in table 3, the vehicle sustained an impact severity, BEV, of approximately 30km/h. The unbelted passenger was seated in the left rear seat, and collided with the left front seat and also the right front seat (see figure 2). No evidence was observed of forward movement beyond the front seats.

The belted left front passenger whose airbag was deployed in the collision sustained small-bowel laceration (AIS 3). It was assumed that this injury was related to the fact that the abdomen of the belted front seat passenger was pressed between the lap belt and seatback. The lap belt's effect on the abdomen could have been influenced by the contact of the rear seat passenger with the right edge of a seatback, causing displacement of lap belt linked to the inner belt.

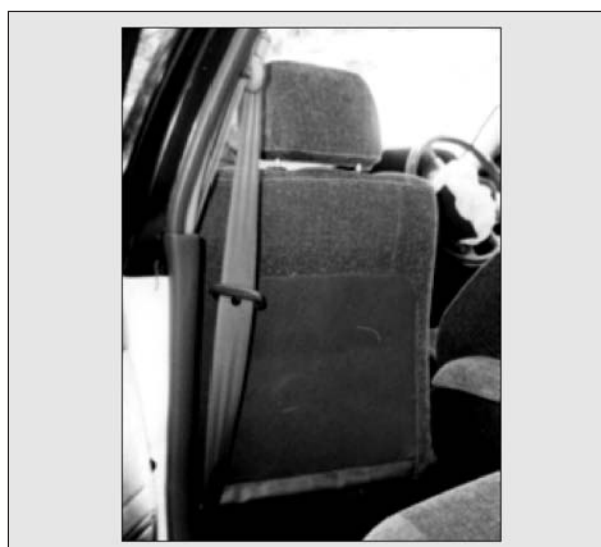

Fig. 1: Deformation of front seat (No. 2)



Fig. 2: Deformation of front seats (No. 4)

Injury Patterns of Front Seat Occupants

In addition to 11 cases shown in table 3, other cases in which injuries of front seat passengers seemed to be related to rear seat passengers were listed, based on movement relations. A total of 22 cases were listed and injury patterns of these cases are shown in table 4.

Injury patterns of front seat occupants appear to have the following characteristics:

Pattern A: A total of 2 injuries, abrasions of upper extremities and contusions over the whole body. Both injuries were AIS 1.

Pattern B: A total of 7 injuries with injuries mainly to the head, chest, pelvis, and upper extremities. There were 2 belted front seat occupants, and one

No	Front seat occupant involved				Rear seat passenger			vehicle			
	Gender Seat	Age	Seat belt Airbag	Major injury induced	Other injuries	Injury Pattern	Seated location	Movement Mode	Contact area	CDC Code	BEV (kmh)
1	Driver	M	Belted	Small bowel laceration (4)		C	RH	I	Edge	12FZE W5	65
2	Pass .	M	Belted	Frail chest (4)	Chest contusion (1), Abdomen contusion (1), Leg contusion (1)	C	LH	I	Center	12FZE W3	45
3	Pass .	F	Belted	Lumber spine sprain(1)	Chest contusion (1)	C	LH	I	Center	12FYEW3	40
4	Pass .	F	Belted	Small bowel laceration (3)		C	LH	I	Edge	12FDE W2	30
5	Pass .	M	Non	Pelvis fracture (3)	Face laceration (1)	C	LH	II	Center	12FRE W5	60
6	Pass .	F	Non	Arm contusion (1)	Face laceration (2), Head contusion (1), Face penetratin (2), Leg contusion (1)	A	LH	III	Edge	01FDE W2	45
7	Pass .	M	Belted	Overall contusion (1)	Shoulder contusion (1), Abdomen contusion (1)	A	LH	III	Edge	12FZE W5	65
8	Driver	M	Non	Head laceration (1)		B	LH	III	Edge	12FYEW5	55
9	Driver	M	Non	Chest contusion (1)	Face laceration (1)	B	CTR	III	Edge	12FLEN3	45
10	Driver	M	Belted	Humerus fracture (2)	Tibia fracture (2), Pelvis fracture (2), Rib fracture (1), Face laceration (1), Arm laceration (1)	B	CTR	III	Edge	12FRE W6	55
11	Driver	M	Belted	Small bowel laceration (3)	Cervical spine sprain (1), Chest contusion (1)	C	RH	III	Center	12FZE W3	45

The figure in parentheses for an injury means AIS. RH means right seat, the one behind a driver, LH is left seat which is behind the front passenger, CTR means middle seat. Edge means that rear seat passengers made contact with the edge of a front seat or the front seat diagonally opposite, whereas, center means that the rear seat passenger made contact around the center of front seat.

Tab. 3: Injuries of front seat occupants thought to be influenced by rear seat passengers

		Rear seat			Total
		Left	Middle	Right	
No front seat occupants		8	0	0	8
No imprints		15	0	7	22
Driver	Pattern A	0	0	0	0
	Pattern B	3	2	1	6
	Pattern C	0	0	6	6
	Unknown	2	(4)	29	35
Front seat passenger	Pattern A	1	1	0	2
	Pattern B	1	0	0	1
	Pattern C	7	0	0	7
	Unknown	31	(4)	1	36
Total		68	11	44	123

Tab. 4: Seating locations and injury patterns of front seat occupants

of them was assumed to have sustained a lumber spine sprain due to twisting of the upper body. Reported sources of these injuries were vehicle parts in front of the occupants, such as the A-pillars and instrument panel. Injury levels were AIS

1 or AIS 2, including 2 cases of bone fractures of the upper extremities. Regarding rear seat passenger movement, 2 cases were mode I, and the remainder mode III. There were cases of the front seat occupant seated on the opposite side as well as those with the occupant in the seat in front of the rear seat passenger.

Pattern C: A total of 13 injuries. In case of belted front seat occupants, injured body areas were the chest or abdomen, and the source of all injuries was reported to be the seat-belt. In the case of unbelted front seat occupants, femur bone fractures or pelvic fractures were listed, and these injuries were reported as indirect injuries due to the contact of legs with instrument panels. AIS 4 injuries were observed as internal organ injuries in case of belted front seat occupants. The movements of rear seat passengers have all modes, I through III. However, the front seat occupant seated in front of the rear seat passenger appeared to be most susceptible to the influence of the rear seat passenger.

Rear seat passenger \ Front seat	Level of deformation			Total
	a	b	c	
Mode I	37	35	10	82
Mode II	0	2	4	6
Mode III	0	6	7	13
Total	37	43	21	101

Tab. 5: Movement modes of unbelted rear seat passengers and deformation of front seats

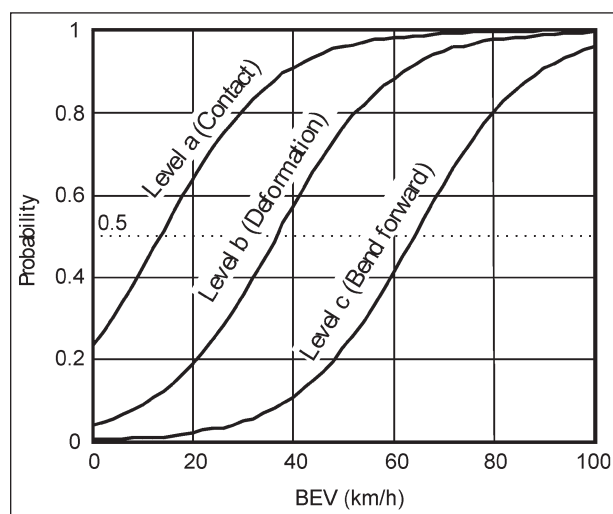

Fig. 3: Cumulative probability curve of seat deformation level

Front Seat Deformation

It is assumed that the larger the deformation of a front seat, the greater the influence on the front seat occupant's injury. Therefore, front seat deformation was analyzed by categorizing deformation in the following levels based on information from inquiry data and photographs: level a) some evidence of contact with rear seat passenger; level b) deformation at hinges or seat slide devices, or forward bending deformation of seatback; level c) seat back deformed beyond plumb line. Table 5 shows the relations between movement modes and deformation of front seats. In mode II or III, deformation was observed in all front seats. In the case of mode I, there were 10 cases of level c deformation and 35 cases of level b.

Front seat deformation is influenced by many factors, including the weight and physique of the rear seat passenger, the seat type, impact severity and vehicle deformation. In this research, the most influential factor, BEV, a measure of impact severity, was taken into account in gauging the level of deformation using the ordered response model [8-

10]. The cumulative probability curve of deformation levels are shown against BEV in figure 3. With a cumulative probability of 0.5 as the threshold velocity of each deformation, it was found that level b for front seat deformation starts around 35km/h, and major deformation of the front seat, level c, begins around 65km/h.

Discussion

The analysis of the statistical accident data reveals that the injury level of front seat occupants in a vehicle in which none of the rear seat passengers wear seat-belts would be more severe than in vehicles in which all rear seat passengers wore seat-belts [1, 7]. In our research, injuries of front seat occupants were analyzed in consideration of how and in what kind of situations injury occurred by use of the detailed accident data. In the detailed accident data, vehicle parts were usually recorded if occupants contacted them, but records of contact between front and rear seat occupants are unfortunately rare. Furthermore, no information was recorded at all on whether injuries of front seat occupants were influenced by rear seat passengers. Therefore, this research focused on front seat occupants in cases where the movement or injuries of front seat occupants appeared to be influenced by rear seat passengers, either due to direct or indirect contact, and the injuries of front seat occupants were evaluated anew from the viewpoint of postulated injury mechanisms. There were some injuries included in patterns A, B and C even if those injuries could have occurred without a rear seat passenger. On the other hand, any injuries for which relations were difficult to explain were categorized as unknown. The seating location of rear seat passengers primarily depended on the testimony of witnesses, though in some cases the deformation of vehicle parts did not correspond with the claimed sitting position. Some of these were considered due to the unusual sitting posture of passengers, and there may have been cases where witnesses did not remember the sitting position of rear seat passengers. In this research, the latter data was eliminated. There was a total of 22 cases where the injuries of front seat passengers appeared to be influenced by the movement of rear seat passengers. Injuries of front seat occupants were categorized in patterns A to C, with 2 cases of pattern A, 7 cases of pattern B and 13 cases of pattern C.

There were many cases and severe injuries in pattern C. Injuries were markedly different depending on the seat-belt use of front seat occupants, and many serious injuries were observed in the chest or abdomen of belted occupants because of internal organ injuries. The chest skeleton usually bears the strong restraining force produced by the seat-belt or the airbag. If additional forces were applied from the back, chest injuries were critical. Abdominal injury is also caused by pressure from the seat-belt and the seatback, although the mechanism is slightly different. This injury is caused by the lap belt moving from iliac crests to abdomen, a phenomenon thought to be induced by seat deformation or direct impact of rear seat passenger on the lap belt.

As chest or abdominal injuries of pattern C were considered significant, a statistical study was conducted to ascertain the influence of unbelted rear seat passengers on the injury level to the chest and abdomen. Vehicles without rear seat passengers were chosen for comparison of vehicles where unbelted rear seat passengers were present instead of vehicles where belted rear seat passengers were present, since the latter number was so small. The injury level to chest and abdomen was divided into 5 ranks in order to apply the ordered response model [8-10]. Each rank was determined as follows: ranks 0 to 3 are the same as AIS 0 to 3 levels, and rank 4 includes AIS 4 to 6. As a result of the analysis, the probability of each rank regarding belted drivers aged 55 years or older was compared between vehicles with unbelted rear seat passengers and the vehicle without rear seat passengers (see figure 4.) The BEV of vehicles with rear seat passengers was found to be 4km/h lower than vehicles without rear seat passengers with a 50% probability and it is presumed that the injury level of front seat occupants would be severer at the same BEV.

Countermeasures to the movement of rear seat passengers or the deformation of front seats include installing a barrier or strengthening seat structures to halt forward movement of rear seat passengers. However, unbelted rear seat passengers have a range of movements during collisions, and it is difficult to use one countermeasure to cover all situations. From this point of view, seat-belt use of rear seat passengers is very effective in protecting front seat occupants.

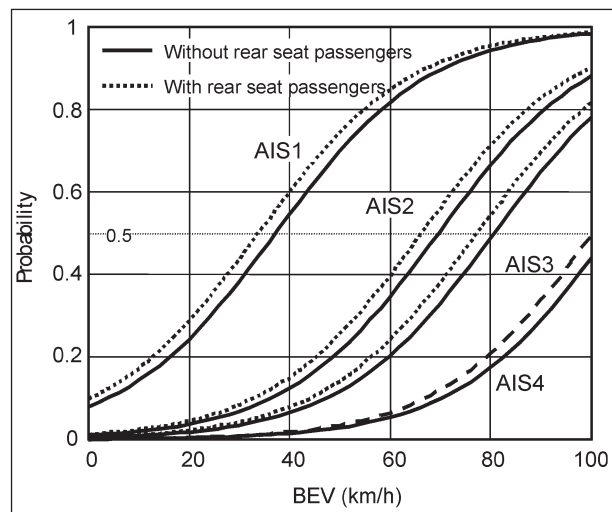

Fig. 4: Cumulative curve of probabilities of injury level of front seat occupants with and without unbelted rear seat passengers

References: Male drivers aged 55 years or older, belted, in ordinary sedan cars without airbag

As results of statistical accident data and detailed accident data, it was revealed that seat-belt use for rear seat passengers is effective not only in mitigating injuries to themselves but also important in reducing injuries to front seat occupants. Nevertheless, there is no indication of an increase in seat-belt use of rear seat passengers as a consequence. The best way to increase belt use is perhaps regulation and enforcement. The seat-belt use of rear seat passengers reached around 80-85% in Victoria, Australia, which introduced mandatory seat-belt use also for rear seats in 1971. In Canada, which also made use of rear seat-belts compulsory, seat-belt use for rear passengers reached 80% [11]. However, in both countries, the rate of seat-belt use in rear seat is still lower than that of front seats. Just before enforcing the regulation, it would be necessary to ask vehicle users to cooperate. Public relations and other enlightenment measures by government are also important. Such enlightenment work aims to increase seat-belt use by appealing not only to the sense of self-protection from one's own seat-belt but also by raising awareness of how injuries to front passengers could be reduced if rear passengers also wore seat-belts. Furthermore, not only should there be appropriate information available to the public and campaigns mounted, but continuous activities also are necessary to stimulate public awareness.

Injuries are influenced by many factors, including age, gender and occupant physique, impact

severity, impact direction, vehicle deformation and the kind of restraint system. Therefore, it would be necessary to investigate detailed accident data continually, and to analyze the relations between rear seat passengers and front seat occupants statistically considering the various factors involved.

Summary

In frontal collisions, most unbelted rear seat passengers stop moving forward at the front seats, though other movements have been observed such as the case where a rear seat passenger flies over a front seat, and the case where a rear seat passenger moves forward beyond the front seats by passing between them.

There are several injury patterns of front seat occupants, one of the most frequent and severest injuries to the chest and abdomen being caused by pressure between the seat-belts or airbag from front and a seatback when pushed from behind by a forward-moving rear seat passenger.

Reducing casualties is important not only from the viewpoint of casualties of unbelted rear seat passengers but also as regards front seat occupants, whose injuries are influenced by unbelted rear seat passengers. Continuous publicity is required to keep the public informed of the necessity of using seat-belts even in the rear seats.

References

- 1 ITARDA: Investigation and research report on the seat belt effectiveness (in Japanese), 211p, 2003
- 2 EVANS, L., 1988:. Rear seat restraint system effectiveness in preventing fatalities, *Accident Analysis and Prevention*, 20 (2), 129-136
- 3 M. KRAFFT, C. NYGREN, C. TINGVALLET: Rear seat occupant protection. A study of children and adults in the rear seat of cars in relation to restraint use and car characteristics, *Journal of Traffic Medicine*, 18 (2), 51-60, 1990
- 4 J. PADMANABAN, R. M. RAY: Safety performance of rear seat occupant restraint systems, 36th STAPP 922524, 193-201, 1992
- 5 D. F. HUELKE, P. COMPTON: Rear seat occupants in frontal crashes – adults and children – the effects of restraint systems, IRCOBI, 1995
- 6 K. SMITH: Road safety: past, present and future, The Travel Bug conference, the Australian Institute of Traffic Planning and Management, 2000
- 7 M. SHIMAMURA, M. YAMAZAKI, G. FUJITA: Effect of Seat-belt Usage of Rear Seat Occupants on Injury Severity of Front Seat Occupants (in Japanese), *Transaction of Society of Automotive Engineers of Japan* 20024195, Vol.3 3, No. 2, 107-112, 2002
- 8 C. J. O'DONNELL, D. H. CONNOR: Predicting the severity of motor vehicle accident injuries using models of ordered multiple choice, *Accid. Anal. and Prev.*, Vol.28, No.6, pp. 739-753, 1996
- 9 K. NAWATA, K. PROBIT, LOGIT, TOBIT. MAKI, A. et al.: *Applied econometrics II* (in Japanese), Section 4, pp. 237-270, Taga-Shuppan, 1997
- 10 M. SHIMAMURA, H. OHASHI, M. YAMAZAKI: The Effects of Occupant Age on Patterns of Rib Fractures to Belt-Restrained Drivers and Front Passengers in Frontal Crashes in Japan, *Stapp Car Crash Journal*, Vol. 47, pp. 349-365, 2003
- 11 Transport Canada: Results of Transport Canada's July 2001 Survey of Seat-Belt Use in Canada, October 2001, Fact Sheet #RS 2001-07, 2001

S. I. Oni
Department of Geography, University of Lagos,
Nigeria

Accident and Whiplash Injuries Prevention in Nigeria

Abstract

Nigeria ranks one of the highest countries in the world with the largest accident, especially when measured by whiplash associated disorders, whereas, traffic safety education rate, data and information been widely known as preventive indicators have been grossly neglected. In Nigeria, traffic safety enlightenment, awareness, political understanding and appreciation of the problem's magnitude are lacking.

This study, therefore, seeks to understand and document the fact that accident causation factors in Nigeria relate more to the problem of development, poverty, knowledge and education as evidenced in most other developing countries.

Among the primary accident causation factors on Nigerian roads are:

- lack of a transportation system or multi-model integration
- sub-standard and obsolete vehicles and road furniture
- poor road maintenance, investment and engineering management
- paucity of road users' and drivers' knowledge, skill, enlightenment and education of the road use

This paper submits that Nigeria being a developing nation requires purely primitive strategies being cost effective (health wise) than curative measures. It is in this light that an enduring, comprehensive and sustainable traffic safety educational programmes information base and data inventory, analysis and implementations form the focus of this study.

This effort will provide basic guidelines framework and implementation procedure for a successful prevention of whiplash associated disorder resulting from road traffic crashes in Nigeria and other parts of the world.

The Problem

A greater proportion of road accidents in Nigeria revolves round the human aspect – the road users/drivers, whereas these are hardly recorded. Basic data and information are lacking, due to awareness, organizational and institutional arrangement take of commitment and poverty.

A poor nation such as Nigeria is hardly able to cope with the crash and post-crash stages, therefore, the only singular and most economic consideration is to adopt prevention measures rather than curative ones.

A problem, which to a great extent still exists, is the limited knowledge about the injury mechanisms, that is, when and how the injuries are generated and at which level they are produced.

Knowledge of impact biomechanics and crashworthiness is the requisite for injury prevention, through fundamental research, which results in the developing principles for effective countermeasures.

This paper will therefore contribute towards developing a guideline to ensuring enduring plans and policy packages for adopting traffic safety education, data collection; usage and management for crash and whiplash prevention.

Research Design

The crash causation factors Investigate are behavioural, road environment and investigation. The management strategies are education, data and information inventorying, which form basic tenets.

Educational packages identified include

- awareness creation at all levels
- curriculum development
- training and retraining programmes
- behavioural studies
- environmental education
- visual impression and Geographic Information Systems (GIS)

Methodology

The study methodology will employ and integrate both descriptive and quantitative approaches at

preventing physiotherapeutic disorders. Roles allocation are to the informal operators – parents, community based and non-governmental organizations, Red Cross Society, religious organizations, voluntary organizations; and formal operators – nursery, elementary, secondary and tertiary institutions, and Research Institutes.

The data required are multi-eclectic and dimensional in approach. Data collection regard the individual operators level of understanding through questionnaires drawn to enquire for before and after crash situation.

- Communications design with credibility
- Observations
- Interviewing, recording and applications
- Questionnaire on Accident reporting
- Photographic illustrations

Nigerian Road Traffic Crash Environment – An Empirical Analysis

Crashes of motor vehicles are not only the leading cause of death in young and middle-aged people, they account for more than 50% or all mortality among young people in their late teen age. They also cause more death of people aged 1-60 than any other injury – producing events. Over 60 percent of severe brain injuries and acute spinal cord injuries are associated with motor vehicles. They cause the most severe permanent medical impairment and most expensive health cost among the injured. This results in an enormous burden on medical resources and huge economical losses for Nigeria.

The nature of the revealed problems implies interdisciplinary solutions, towards having total system improvements.

These include legislative measures, knowledge on the sensory-motor characteristics of the driver and vehicle dynamics, but more importantly road user education.

In order to maximize the overall efficiency and safety, education and training are necessary complements to legislation and vehicle design. However, these steps should not be taken as substitutes for immediate technological measures when they are possible. Some vehicle dynamics phenomena are known and should be explained in driver education to make the requirements on the

drivers more reasonable. As such, results from empirical research can be spread and used in education of other road users as well.

Whiplash Injuries and Preventive Measures

Whiplash injuries have been one of the most controversial issues in medicine for over 100 years and at the forefront is the problem of low velocity collisions. Rear impacts often result in neck injuries to the occupants of the struck car. Driving the collision, the vehicle is subjected to a forward acceleration and the car occupants are pushed forward by the seat backs. The head moves forward and stops in a somewhat flexed neck posture. This type of swift injuries extension – flexion motion of the neck is usually called "Whiplash motion". The injury symptoms following neck trauma in rear-end collisions include pain, weakness or abnormal response in the neck, vision disorders, dizziness, headaches and unconsciousness (LOVSUND, 1996).

For effective preventive measures on whiplash injuries, the following four aspects of knowledge should be well understood through sound education and data inventorying and analysis.

1. Strong laws of physics, that is, the physical laws that determine the movement of the body during a collision, and the role they play in whiplash.
2. Biomechanics – detailed analysis of human movements during a collision with information on occupant.
3. Mechanisms of injuring – understanding each phase of the collision and probable injuring type which may occur, as well as the myriad anatomical structures that can be traumatized in a low speed collision.
4. Factors and variables involved in whiplash injuries – seat back characteristics, air bags, body position and posture, head restraints, bumpers, road conditions, seat-belts and defensive driving.

Biomechanics – Health Losses and Costs Reduction

Countermeasures within the traffic safety can – definitely be regarded as a potential increase of the

public health. Countermeasures have to be taken in general areas, and require a multidisciplinary approach. So far the most effective results have been achieved by injury preventive measures. This requires an increased basic knowledge about impact biomechanics and crashworthiness, as there are many gaps which still require further research.

The central research design for whiplash reduction can be summarized as follows:

- Analyse traffic accidents and the produced injuries and perform reconstructions.
- Identify and define injury mechanisms with regard to different types of loading conditions.
- Quantify the physical responses of body tissues and organ systems with regard to various impact conditions (structural effects).
- Determine the level of response (magnitude, duration, strain rate, etc.) at which the tissues and systems will fail (functional effects).
- Develop mechanical and mathematical models, which respond to various impacts in a human like manner, for development and evaluation of protective systems.
- Develop protective materials, structures and systems that lower the level of impact energy and force in order to reduce the risk of injury.

When designing less injurious environments to improve the protection of car occupants it is necessary to have a thorough understanding of the mechanisms that cause injuries and disabilities. Furthermore knowledge of the effects of specific kinds and amounts of energy on specific human tissues is required as well as knowledge of material mechanics of non biological materials such as polymers and the interaction between them.

Research in biomechanics thus involves a variety of disciplines, including engineering (e.g. mechanics, solid mechanics, material mechanics, measurement techniques, applied physics, thermos – and fluid dynamics), physiology, medicine, biology, anatomy, dentistry, and epidemiology.

Epidemiology of Injury

A prerequisite for the scientific study of injury is the acquisition and analysis of data on which to base

priorities and research. The situation today in data validity and reliability can be highly questioned in the sense, that controlled studies of human tolerance, accident severity distribution and effectiveness of protective systems etc. cannot be performed in a scientifically correct way. Errors and confounding factors are known but complicate to control or diminish. The research goal is to develop methods to collect high quality data from real accidents, including on-board techniques. It is also of importance to develop methods to describe the outcome of injuries in a way that is valid for one individual and for the population at risk including especially long-term consequences and the loss of health. By combining reliable data on exposure and valid measurements of injury, dose-response models for accident research can be developed in the future.

Whiplash Injury Reduction Strategies

Implementing the strategies:

1. Raising awareness on Whiplash Injury Reduction Strategy through – traffic safety education on the basis of the Instruction Guideline of Traffic Safety Education
 - more participatory, practical education methods through risk evaluation and danger avoidance in an air of familiarity actions review and adoption of safe standards of behaviour
 - publicity and awareness creation
 - reflective materials being advertised and promoted
2. Creating a safe traffic environment through installation and provision of basic safety devices, traffic signals and facilities which ensure safety.
3. Education license renewal lectures and driver aptitude
4. Brakes requiring less strength
5. More research studies for formulating safety strategies
6. Installation of a road traffic system using sophisticated telecommunications systems
7. Complete compliance with seat-belt usage requirement

8. Community traffic safety education
9. Public relations campaign concerning the use of mobile telephones while drinking
10. Introduction of comprehensive surveys on traffic safety
11. Improvement of safety standards for road transport vehicles
12. Development of assistance on the Advanced Safety Vehicle (ASV)
13. Vehicle Safety Information Service
 - Here collision safety performance and other vehicle safety performance data should be collected and communicated in a form which is easily understandable for users

Traffic Safety Education

Road traffic safety education in Nigeria and other places could focus on

- the responsibility of vulnerable road users,
- appealing to the attitude of drivers to voluntarily drive more carefully and responsibly promoting secondary safety measures, such as the use of seat-belts, child restraints, conspicuity aids, cycle helmets, and ever more crashworthy cars.

Introducing road safety education in school children's curriculum is very important. Although road safety education has faced a lot of criticism it still remains one of the effective measures in road traffic accident reduction and prevention.

This paper emphasizes that training and retraining of the drivers is a formidable means of effectively dealing with the issue of whiplash reduction.

Conclusion

This study pursues both qualitative and quantitative approaches, ensuring discussions on training, retraining from analysis and results presentations on the level of success. The outcome of which would be the reduction whiplash-associated disorders by a certain percentage over a visionary period of 10 years. The research results form a sound basis for future traffic safety environment devoid of whiplash-associated disorders by 50% over 10 years.

Schriftenreihe

Berichte der Bundesanstalt für Straßenwesen

Unterreihe „Fahrzeugtechnik“

1993

- F 1: Einfluß der Korrosion auf die passive Sicherheit von Pkw
Faerber, Wobben € 12,50
- F 2: Kriterien für die Prüfung von Motorradhelmen
König, Werner, Schuller, Beier, Spann € 13,50
- F 3: Sicherheit von Motorradhelmen
Zellmer € 11,00
- F 4: Weiterentwicklung der Abgassonderuntersuchung
Teil 1: Vergleich der Ergebnisse aus Abgasuntersuchung und Typprüfverfahren
Richter, Michelmann
Teil 2: Praxiserprobung des vorgesehenen Prüfverfahrens für Fahrzeuge mit Katalysator
Albus € 13,50

1994

- F 5: Nutzen durch fahrzeugseitigen Fußgängerschutz
Bamberg, Zellmer € 11,00
- F 6: Sicherheit von Fahrradanhängern zum Personentransport
Wobben, Zahn € 12,50
- F 7: Kontrastwahrnehmung bei unterschiedlicher Lichttransmission von Pkw-Scheiben
Teil 1: Kontrastwahrnehmung im nächtlichen Straßenverkehr bei Fahrern mit verminderter Tagesschärfe
P. Junge
Teil 2: Kontrastwahrnehmung in der Dämmerung bei Fahrern mit verminderter Tagesschärfe
Chmielarz, Siegl
Teil 3: Wirkung abgedunkelter Heckscheiben - Vergleichsstudie
Derkum € 14,00
- F 8: Anforderungen an den Kinnschutz von Integralhelmen
Otte, Schroeder, Eidam, Kraemer € 10,50
- F 9: Kraftschlußpotentiale moderner Motorradreifen unter Straßenbedingungen
Schmieder, Bley, Spickermann, von Zettlmann € 11,00

1995

- F 10: Einsatz der Gasentladungslampe in Kfz-Scheinwerfern
Damasky € 12,50
- F 11: Informationsdarstellung im Fahrzeug mit Hilfe eines Head-Up-Displays
Mutschler € 16,50
- F 12: Gefährdung durch Frontschutzbügel an Geländefahrzeugen
Teil 1: Gefährdung von Fußgängern und Radfahrern
Zellmer, Schmid
Teil 2: Quantifizierung der Gefährdung von Fußgängern
Zellmer € 12,00
- F 13: Untersuchung rollwiderstandsarmer Pkw-Reifen
Sander € 11,50

1996

- F 14: Der Aufprall des Kopfes auf die Fronthaube von Pkw beim Fußgängerunfall – Entwicklung eines Prüfverfahrens
Glaeser € 15,50
- F 15: Verkehrssicherheit von Fahrrädern
Teil 1: Möglichkeiten zur Verbesserung der Verkehrssicherheit von Fahrrädern
Heinrich, von der Osten-Sacken
Teil 2: Ergebnisse aus einem Expertengespräch „Verkehrssicherheit von Fahrrädern“
Nicklisch € 22,50
- F 16: Messung der tatsächlichen Achslasten von Nutzfahrzeugen
Sagerer, Wartenberg, Schmidt € 12,50
- F 17: Sicherheitsbewertung von Personenkraftwagen – Problemanalyse und Verfahrenskonzept
Grunow, Heuser, Krüger, Zangemeister € 17,50
- F 18: Bremsverhalten von Fahrern von Motorrädern mit und ohne ABS
Präckel € 14,50
- F 19: Schwingungsdämpferprüfung an Pkw im Rahmen der Hauptuntersuchung
Pullwitt € 11,50
- F 20: Vergleichsmessungen des Rollwiderstands auf der Straße und im Prüfstand
Sander € 13,00
- F 21: Einflußgrößen auf den Kraftschluß bei Nässe
Fach € 14,00

1997

- F 22: Schadstoffemissionen und Kraftstoffverbrauch bei kurzzeitiger Motorabschaltung
Bugsel, Albus, Sievert € 10,50
- F 23: Unfalldatenschreiber als Informationsquelle für die Unfallforschung in der Pre-Crash-Phase
Berg, Mayer € 19,50

1998

- F 24: Beurteilung der Sicherheitsaspekte eines neuartigen Zweiradkonzeptes
Kalliske, Albus, Faerber € 12,00
- F 25: Sicherheit des Transportes von Kindern auf Fahrrädern und in Fahrradanhängern
Kalliske, Wobben, Nee € 11,50

1999

- F 26: Entwicklung eines Testverfahrens für Antriebsschlupf-Regelsysteme
Schweers € 11,50
- F 27: Betriebslasten an Fahrrädern
Vötter, Groß, Esser, Born, Flamm, Rieck € 10,50
- F 28: Überprüfung elektronischer Systeme in Kraftfahrzeugen
Kohlstruck, Wallentowitz € 13,00

2000

- F 29: Verkehrssicherheit runderneuerter Reifen
Teil 1: Verkehrssicherheit runderneuerter Reifen
Glaeser
Teil 2: Verkehrssicherheit runderneuerter Lkw-Reifen
Aubel € 13,00

- F 30: **Rechnerische Simulation des Fahrverhaltens von Lkw mit Breitreifen**
Faber € 12,50
- F 31: **Passive Sicherheit von Pkw bei Verkehrsunfällen**
Otte € 12,50
- F 32: **Die Fahrzeugtechnische Versuchsanlage der BASt – Einweihung mit Verleihung des Verkehrssicherheitspreises 2000 am 4. und 5. Mai 2000 in Bergisch Gladbach**
€ 14,00
- F 33: **Sicherheitsbelange aktiver Fahrdynamikregelungen**
Gaupp, Wobben, Horn, Seemann € 17,00

2001

- F 34: **Ermittlung von Emissionen im Stationärbetrieb mit dem Emissions-Mess-Fahrzeug**
Sander, Bugsel, Sievert, Albus € 11,00
- F 35: **Sicherheitsanalyse der Systeme zum Automatischen Fahren**
Wallentowitz, Ehmanns, Neunzig, Weilkes, Steinauer, Bölling, Richter, Gaupp € 19,00
- F 36: **Anforderungen an Rückspiegel von Kraffträdern**
van de Sand, Wallentowitz, Schrüllkamp € 14,00
- F 37: **Abgasuntersuchung - Erfolgskontrolle: Ottomotor – G-Kat**
Afflerbach, Hassel, Schmidt, Sonnborn, Weber € 11,50
- F 38: **Optimierte Fahrzeugfront hinsichtlich des Fußgängerschutzes**
Friesen, Wallentowitz, Philipps € 12,50

2002

- F 39: **Optimierung des rückwärtigen Signalbildes zur Reduzierung von Auffahrunfällen bei Gefahrenbremsung**
Gail, Lorig, Gelau, Heuzeroth, Sievert € 19,50
- F 40: **Prüfverfahren für Spritzschutzsysteme an Kraftfahrzeugen**
Domsch, Sandkühler, Wallentowitz € 16,50

2003

- F 41: **Abgasuntersuchung: Dieselfahrzeuge**
Afflerbach, Hassel, Mäurer, Schmidt, Weber € 14,00
- F 42: **Schwachstellenanalyse zur Optimierung des Notausstiegssystems bei Reisebussen**
Krieg, Rüter, Weißgerber € 15,00
- F 43: **Testverfahren zur Bewertung und Verbesserung von Kinderschutzsystemen beim Pkw-Seitenaufprall**
Nett € 16,50
- F 44: **Aktive und passive Sicherheit gebrauchter Leichtkraftfahrzeuge**
Gail, Pastor, Spiering, Sander, Lorig € 12,00

2004

- F 45: **Untersuchungen zur Abgasemission von Motorrädern im Rahmen der WMTC-Aktivitäten**
Steven € 12,50
- F 46: **Anforderungen an zukünftige Kraffrad-Bremssysteme zur Steigerung der Fahrsicherheit**
Funke, Winner € 12,00
- F 47: **Kompetenzerwerb im Umgang mit Fahrerinformationssystemen**
Jahn, Oehme, Rösler, Krems € 13,50
- F 48: **Standgeräuschmessung an Motorrädern im Verkehr und bei der Hauptuntersuchung nach § 29 STVZO**
Pullwitt, Redmann € 13,50

- F 49: **Prüfverfahren für die passive Sicherheit motorisierter Zweiräder**
Berg, Rücker, Mattern, Kallieris € 18,00
- F 50: **Seitenairbag und Kinderrückhaltesysteme**
Gehre, Kramer, Schindler € 14,50
- F 51: **Brandverhalten der Innenausstattung von Reisebussen**
Egelhaaf, Berg, Staubach, Lange € 16,50
- F 52: **Intelligente Rückhaltesysteme**
Schindler, Kühn, Siegler € 16,00
- F 53: **Unfallverletzungen in Fahrzeugen mit Airbag**
Klanner, Ambios, Paulus, Hummel, Langwieder, Köster € 15,00
- F 54: **Gefährdung von Fußgängern und Radfahrern an Kreuzungen durch rechts abbiegende Lkw**
Niewöhner, Berg € 16,50
- F 55: **1st International Conference on ESAR „Expert Symposium on Accident Research“ – Reports on the ESAR-Conference on 3rd/4th September 2004 at Hannover Medical School**
€ 29,00

Alle Berichte sind zu beziehen beim:

Wirtschaftsverlag NW
Verlag für neue Wissenschaft GmbH
Postfach 10 11 10
D-27511 Bremerhaven
Telefon: (04 71) 9 45 44 - 0
Telefax: (04 71) 9 45 44 77
Email: vertrieb@nw-verlag.de
Internet: www.nw-verlag.de

Dort ist auch ein Kompletverzeichnis erhältlich.